

The ECJ Owner's Manual

A User Manual for the ECJ Evolutionary Computation Library

Sean Luke

Department of Computer Science
George Mason University

Manual Version 27

August 30, 2019

Where to Obtain ECJ

<http://cs.gmu.edu/~eclab/projects/ecj/>

Copyright 2010–2019 by Sean Luke.

Thanks to Carlotta Domeniconi.

Get the latest version of this document or suggest improvements here:

<http://cs.gmu.edu/~eclab/projects/ecj/>

This document is licensed under the **Creative Commons Attribution-No Derivative Works 3.0 United States License**, except for those portions of the work licensed differently as described in the next section. To view a copy of this license, visit <http://creativecommons.org/licenses/by-nd/3.0/us/> or send a letter to Creative Commons, 171 Second Street, Suite 300, San Francisco, California, 94105, USA. A quick license summary:

- You are free to redistribute this document.
- **You may not** modify, transform, translate, or build upon the document except for personal use.
- You must maintain the author's attribution with the document at all times.
- You may not use the attribution to imply that the author endorses you or your document use.

This summary is just informational: if there is any conflict in interpretation between the summary and the actual license, the actual license always takes precedence.

This document is was produced in part through funding from grants 0916870 and 1317813 from the National Science Foundation.

Contents

1	Introduction	7
1.1	About ECJ	7
1.2	Overview	9
1.3	Unpacking ECJ and Using the Tutorials	14
1.3.1	The ec Directory, the CLASSPATH, and jar files	15
1.3.1.1	The ec/display Directory: ECJ's GUI	15
1.3.1.2	The ec/app Directory: Demo Applications	15
1.3.2	The docs Directory	15
1.3.2.1	Tutorials	16
2	ec.Evolve and Utility Classes	17
2.1	The Parameter Database	18
2.1.1	Inheritance	19
2.1.2	Kinds of Parameters	20
2.1.3	Namespace Hierarchies and Parameter Bases	22
2.1.4	Parameter Files in Jar Files	24
2.1.5	Accessing Parameters	25
2.1.6	Parameter Macros	28
2.1.6.1	The Alias Macro	28
2.1.7	Debugging Your Parameters	29
2.1.8	Building a Parameter Database from Scratch	31
2.2	Output	33
2.2.1	Creating and Writing to Logs	33
2.2.2	Quieting the Program	35
2.2.3	The ec.util.Code Class	35
2.2.3.1	Decoding the Hard Way	36
2.2.3.2	Decoding the Easy Way	37
2.3	Checkpointing	38
2.3.1	Implementing Checkpointable Code	40
2.4	Threads and Random Number Generation	41
2.4.1	Random Numbers	41
2.4.2	Selecting Randomly from Distributions	44
2.4.3	Thread-Local Storage	46
2.4.4	Multithreading Support	46
2.5	Jobs	47
2.6	The ec.Evolve Top-level	48
2.7	Integrating ECJ with other Applications or Libraries	50
2.7.1	Control by ECJ	50
2.7.2	Control by another Application or Library	54

3	ec.EvolutionState and the ECJ Evolutionary Process	57
3.1	Common Patterns	59
3.1.1	Setup	59
3.1.2	Singletons and Cliques	59
3.1.3	Prototypes	59
3.1.4	The Flyweight Pattern	60
3.1.5	Groups	60
3.2	Populations, Subpopulations, Species, Individuals, and Fitnesses	61
3.2.1	Making Large Numbers of Subpopulations	63
3.2.2	How Species Make Individuals	64
3.2.3	Reading and Writing Populations and Subpopulations	64
3.2.4	About Individuals	66
3.2.4.1	Implementing an Individual	66
3.2.5	About Fitnesses	68
3.3	Initializers and Finishers	70
3.3.1	Population Files and Subpopulation Files	72
3.4	Evaluators and Problems	73
3.4.1	Problems	74
3.4.2	Implementing a Problem	75
3.5	Breeders	77
3.5.1	Breeding Pipelines and BreedingSources	80
3.5.1.1	Auxiliary Data	81
3.5.2	SelectionMethods	81
3.5.2.1	Implementing a Simple SelectionMethod	82
3.5.2.2	Standard Classes	83
3.5.3	BreedingPipelines	86
3.5.3.1	Implementing a Simple BreedingPipeline	88
3.5.3.2	Standard Utility Pipelines	89
3.5.4	Setting up a Pipeline	93
3.5.4.1	A Genetic Algorithm Pipeline	93
3.5.4.2	A Genetic Programming Pipeline	94
3.6	Exchangers	95
3.7	Statistics	95
3.7.1	Creating a Statistics Chain	98
3.7.2	Tabular Statistics	98
3.7.3	Quieting the Statistics	101
3.7.4	Implementing a Statistics Object	101
3.8	Debugging an Evolutionary Process	103
4	Basic Evolutionary Processes	109
4.1	Generational Evolution	109
4.1.1	The Genetic Algorithm (The ec.simple Package)	111
4.1.2	Evolution Strategies (The ec.es Package)	113
4.2	Steady-State Evolution (The ec.steadystate Package)	117
4.2.1	Steady State Statistics	120
4.2.2	Producing More than One Individual at a Time	120
4.3	Single-State Methods (The ec.singlestate Package)	122
4.3.1	Simple Hill-Climbing and (1+1)	122
4.3.2	Steepest Ascent Hill-Climbing and (1+ λ)	123
4.3.3	Steepest Ascent Hill-Climbing With Replacement and (1, λ)	124
4.3.4	Simulated Annealing	125

5	Representations	127
5.1	Vector and List Representations (The <code>ec.vector</code> Package)	127
5.1.1	Vectors	128
5.1.1.1	Initialization	129
5.1.1.2	Crossover	130
5.1.1.3	Multi-Vector Crossover	133
5.1.1.4	Mutation	133
5.1.1.5	Heterogeneous Vector Individuals	139
5.1.2	Lists	141
5.1.2.1	Utility Methods	141
5.1.2.2	Initialization	142
5.1.2.3	Crossover	142
5.1.2.4	Mutation	143
5.1.3	Arbitrary Genes: <code>ec.vector.Gene</code>	144
5.2	Genetic Programming (The <code>ec.gp</code> Package)	146
5.2.1	GPNodes, GPTrees, and GPIndividuals	148
5.2.1.1	GPNodes	149
5.2.1.2	GPTrees	149
5.2.1.3	GPIndividual	150
5.2.1.4	GPNodeConstraints	150
5.2.1.5	GPTreeConstraints	150
5.2.1.6	GPFunctionSet	150
5.2.2	Basic Setup	151
5.2.2.1	Defining GPNodes	152
5.2.3	Defining the Representation, Problem, and Statistics	153
5.2.3.1	GPData	154
5.2.3.2	KozaFitness	155
5.2.3.3	GPProblem	156
5.2.3.4	GPNode Subclasses	157
5.2.3.5	Statistics	159
5.2.4	Initialization	160
5.2.5	Breeding	164
5.2.6	A Complete Example	171
5.2.7	GPNodes in Depth	174
5.2.8	GPTrees and GPIndividuals in Depth	178
5.2.8.1	Pretty-Printing Trees	179
5.2.8.2	GPIndividuals	182
5.2.9	Ephemeral Random Constants	182
5.2.10	Automatically Defined Functions and Macros	185
5.2.10.1	About ADF Stacks	188
5.2.11	Strongly Typed Genetic Programming	191
5.2.11.1	Inside GPTypes	196
5.2.12	Parsimony Pressure (The <code>ec.parsimony</code> Package)	197
5.3	Grammatical Evolution (The <code>ec.gp.ge</code> Package)	199
5.3.1	GEIndividuals, GESpecies, and Grammars	200
5.3.1.1	Strong Typing	201
5.3.1.2	ADFs and ERCs	202
5.3.2	Translation and Evaluation	202
5.3.3	Printing	204
5.3.4	Initialization and Breeding	205
5.3.5	Dealing with GP	206
5.3.6	A Complete Example	206

5.3.6.1	Grammar Files	208
5.3.7	How Parsing is Done	208
5.4	Push (The ec.gp.push Package)	209
5.4.1	Push and GP	211
5.4.2	Defining the Push Instruction Set	212
5.4.3	Creating a Push Problem	213
5.4.4	Building a Custom Instruction	214
5.5	NEAT (The ec.neat Package)	215
5.5.1	Building a NEAT Application	216
5.5.1.1	Breeding	216
5.5.1.2	Evaluation	219
5.6	Rulesets and Collections (The ec.rule Package)	222
5.6.1	RuleIndividuals and RuleSpecies	222
5.6.2	RuleSets and RuleSetConstraints	223
5.6.3	Rules and RuleConstraints	226
5.6.4	Initialization	228
5.6.5	Mutation	228
5.6.6	Crossover	229
6	Parallel Processes	231
6.1	Distributed Evaluation (The ec.eval Package)	231
6.1.1	The Master	232
6.1.2	Slaves	233
6.1.3	Opportunistic Evolution	235
6.1.4	Asynchronous Evolution	237
6.1.5	The MasterProblem	238
6.1.6	Noisy Distributed Problems	240
6.2	Island Models (The ec.exchange Package)	241
6.2.1	Islands	241
6.2.2	The Server	243
6.2.2.1	Synchronicity	244
6.2.3	Internal Island Models	245
6.2.4	The Exchanger	246
7	Additional Evolutionary Algorithms	249
7.1	Coevolution (The ec.coevolve Package)	249
7.1.1	Coevolutionary Fitness	249
7.1.2	Grouped Problems	250
7.1.3	One-Population Competitive Coevolution	252
7.1.4	Multi-Population Coevolution	254
7.1.4.1	Parallel and Sequential Coevolution	256
7.1.4.2	Maintaining Context	257
7.1.5	Performing Distributed Evaluation with Coevolution	258
7.2	Spatially Embedded Evolutionary Algorithms (The ec.spatial Package)	259
7.2.1	Implementing a Space	260
7.2.2	Spatial Breeding	261
7.2.3	Coevolutionary Spatial Evaluation	262
7.3	Particle Swarm Optimization (The ec.pso Package)	263
7.4	Differential Evolution (The ec.de Package)	267
7.4.1	Evaluation	267
7.4.2	Breeding	267
7.4.2.1	The DE/rand/1/bin Operator	269

7.4.2.2	The DE/best/1/bin Operator	269
7.4.2.3	The DE/rand/1/either-or Operator	270
7.5	Multiobjective Optimization (The ec.multiobjective Package)	271
7.5.0.1	The MultiObjectiveFitness class	271
7.5.0.2	The MultiObjectiveStatistics class	273
7.5.0.3	Measuring Hypervolume	274
7.5.1	Selecting with Multiple Objectives	275
7.5.1.1	Pareto Ranking	275
7.5.1.2	Archives	276
7.5.2	NSGA-II/III (ec.multiobjective.nsga2 and ec.multiobjective.nsga3 Packages)	276
7.5.3	SPEA2 (The ec.multiobjective.spea2 Package)	277
7.6	Estimation of Distribution Algorithms	278
7.6.1	PBIL	278
7.6.2	CMA-ES	280
7.6.2.1	Parameters	281
7.6.3	iAMaLGaM IDEA	283
7.6.4	DOvS	285
7.7	Ant Colony Optimization and GRASP	287
7.7.1	Ant Colony Optimization	288
7.7.1.1	Ant System	288
7.7.1.2	Ant Colony System	290
7.7.2	GRASP	292
7.8	Meta-Evolutionary Algorithms	293
7.8.1	The Two Parameter Files	293
7.8.2	Defining the Parameters	296
7.8.3	Statistics and Messages	298
7.8.4	Populations Versus Generations	298
7.8.5	Using Meta-Evolution with Distributed Evaluation	299
7.8.6	Customization	300
7.9	Resets (The ec.evolve Package)	302

Chapter 1

Introduction

The purpose of this manual is to describe practically every feature of ECJ, an evolutionary computation toolkit. It's not a good choice of reading material if your goal is to learn the system from scratch. It's very terse, boring, and long, and not organized as a tutorial but rather as an encyclopedia. Instead, I refer you to ECJ's four tutorials and various other documentation that comes with the system. But when you need to know about some particular gizmo that ECJ has available, this manual is where to look.

1.1 About ECJ

ECJ is an evolutionary computation framework written in Java. The system was designed for large, heavy-weight experimental needs and provides tools which provide many popular EC algorithms and conventions of EC algorithms, but with a particular emphasis towards genetic programming. ECJ is free open-source with a BSD-style academic license (AFL 3.0).

ECJ is now well over fifteen years old and is a mature, stable framework which has (fortunately) exhibited relatively few serious bugs over the years. Its design has readily accommodated many later additions, including multiobjective optimization algorithms, island models, master/slave evaluation facilities, coevolution, steady-state and evolution strategies methods, parsimony pressure techniques, and various new individual representations (for example, rule-sets). The system is widely used in the genetic programming community and is reasonably popular in the EC community at large. I myself have used it in over thirty or forty publications.

A toolkit such as this is not for everyone. ECJ was designed for big projects and to provide many facilities, and this comes with a relatively steep learning curve. We provide tutorials and many example applications, but this only partly mitigates ECJ's imposing nature. Further, while ECJ is *extremely* "hackable", the initial development overhead for starting a new project is relatively large. As a result, while I feel ECJ is an excellent tool for many projects, other tools might be more apropos for quick-and-dirty experimental work.

Why ECJ was Made ECJ's primary inspiration comes from *lil-gp* [21], to which it owes much. Homage to *lil-gp* may be found in ECJ's command-line facility, how it prints out messages, and how it stores statistics.

Work on ECJ commenced in Fall 1998 after experiences with *lil-gp* in evolving simulated soccer robot teams [9]. This project involved heavily modifying *lil-gp* to perform parallel evaluations, a simple coevolutionary procedure, multiple threading, and strong typing. Such modifications made it clear that *lil-gp* could not be further extended without considerable effort, and that it would be worthwhile developing an "industrial-grade" evolutionary computation framework in which GP was one of a number of orthogonal features. I intended ECJ to provide at least ten years of useful life, and I believe it has performed well so far.

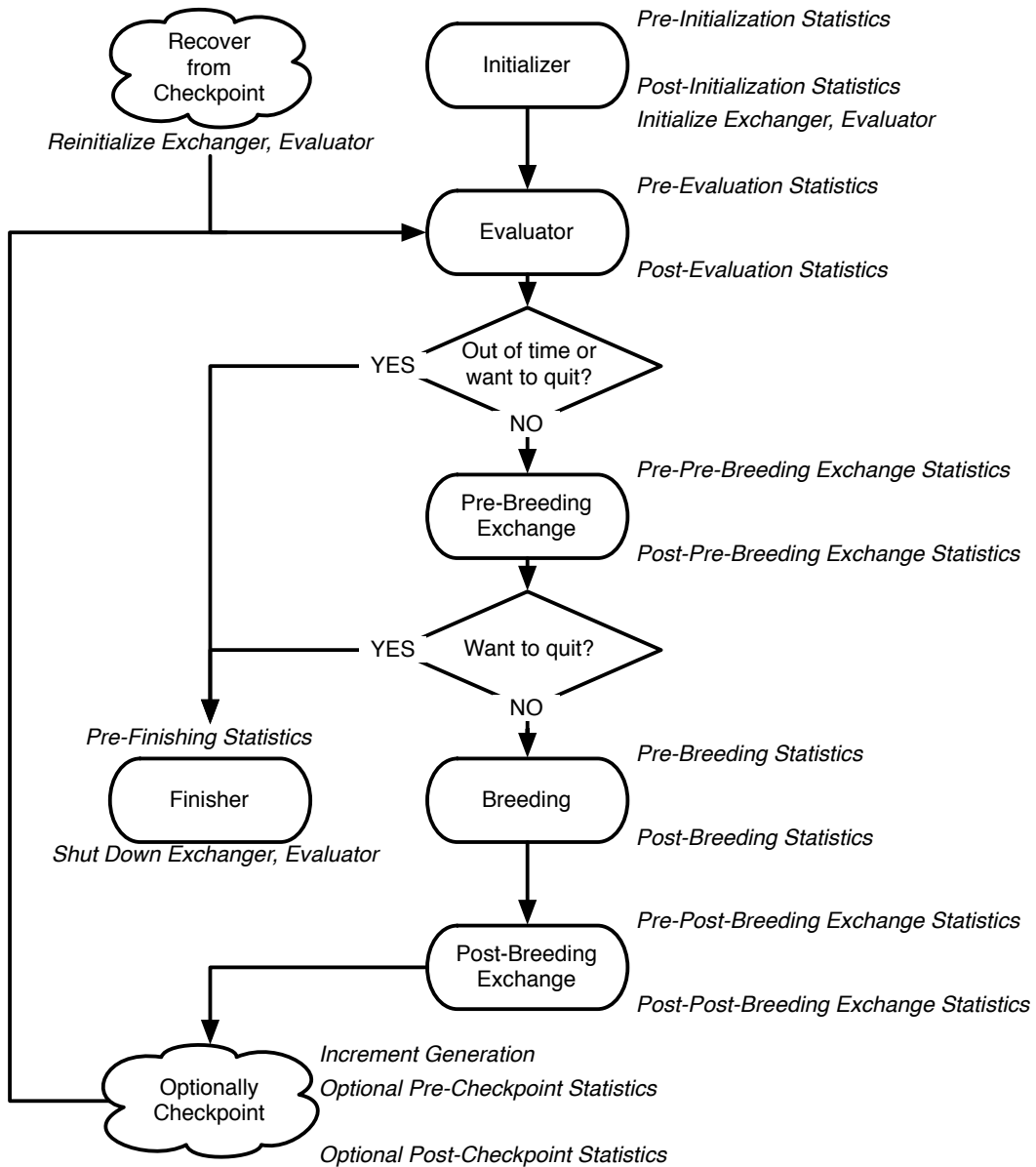

Figure 1.1 Top-Level Loop of ECJ's SimpleEvolutionState class, used for basic generational EC algorithms. Various sub-operations are shown occurring before or after the primary operations. The full population is revised each iteration.

1.2 Overview

ECJ is a general-purpose evolutionary computation framework which attempts to permit as many valid combinations as possible of individual representation and breeding method, fitness and selection procedure, evolutionary algorithm, and parallelism.

Top-level Loop ECJ hangs the entire state of the evolutionary run off of a single instance of a subclass of `EvolutionState`. This enables ECJ to serialize out the entire state of the system to a checkpoint file and to recover it from the same. The `EvolutionState` subclass chosen defines the kind of top-level evolutionary loop used in the ECJ process. We provide two such loops: a simple generational loop with optional elitism, and a steady-state loop.

Figure 1.1 shows the top-level loop of the simple generational `EvolutionState`. The loop iterates between breeding and evaluation, with an optional “exchange” period after each. Statistics hooks are called before and after each period of breeding, evaluation, and exchanging, as well as before and after initialization of the population and “finishing” (cleaning up prior to quitting the program).

Breeding and evaluation are handled by singleton objects known as the `Breeder` and `Evaluator` respectively. Likewise, population initialization is handled by an `Initializer` singleton, and finishing is done by a `Finisher`. Exchanges after breeding and after evaluation are handled by an `Exchanger`. The particular versions of these singleton objects are determined by the experimenter, though we provide versions which perform common tasks. For example, we provide a traditional-EA `SimpleEvaluator`, a steady-state EA `SteadyStateEvaluator`, a “single-population coevolution” `CompetitiveEvaluator`, and a multi-population coevolution `MultiPopCoevolutionaryEvaluator`, among others. There are likewise custom breeders and initializers for different functions. The `Exchanger` provides an opportunity for other hooks, notably internal and external island models. For example, post-breeding exchange might allow external immigrants to enter the population, while emigrants might leave the population during post-evaluation exchange. These singleton operators comprise most of the high-level “verbs” in the ECJ system, as shown in Figure 1.2.

Parameterized Construction ECJ is unusually heavily parameterized: practically every feature of the system is determined at runtime from a parameter. Parameters define the classes of objects, the specific subobjects they hold, and all of their initial runtime values. ECJ does this through a bootstrap class called `Evolve`, which loads a `ParameterDatabase` from runtime parameter files at startup. Using this database, `Evolve` constructs the top-level `EvolutionState` and tells it to “setup” itself. `EvolutionState` in turn calls subsidiary classes (such as `Evaluator`) and tells them to “setup” themselves from the database. This procedure continues down the chain until the entire system is constructed.

State Objects In addition to “verbs”, `EvolutionState` also holds “nouns” — the state objects representing the things being evolved. Specifically, `EvolutionState` holds exactly one `Population`, which contains some N (typically 1) `Subpopulations`. Multiple `Subpopulations` permit experiments in coevolution, internal island models, etc. Each `Subpopulation` holds some number of `Individuals` and the `Species` to which the `Individuals` belong. `Species` is a flyweight object for `Individual`: it provides a central repository for things common to many `Individuals` so they don’t have to each contain them in their own instances.

While running, numerous state objects must be created, destroyed, and recreated. As ECJ only learns the specific classes of these objects from the user-defined parameter file at runtime, it cannot simply construct them using Java’s `new` operator. Instead such objects are created by constructing a *prototype* object at startup time, and then using this object to stamp out copies of itself as often as necessary. For example, `Species` contains a prototypical `Individual`. When new `Individuals` must be created for a given `Subpopulation`, they are copied from the `Subpopulation`’s `Species` and then customized. This allows different `Subpopulations` to use different `Individual` representations.

In keeping with its philosophy of orthogonality, ECJ defines `Fitnesses` separate from `Individuals` (representations), and provides both single-objective and multi-objective `Fitness` subclasses. In addition to holding a prototypical `Individual`, `Species` also hold the prototypical `Fitness` to be used with that kind of `Individual`.

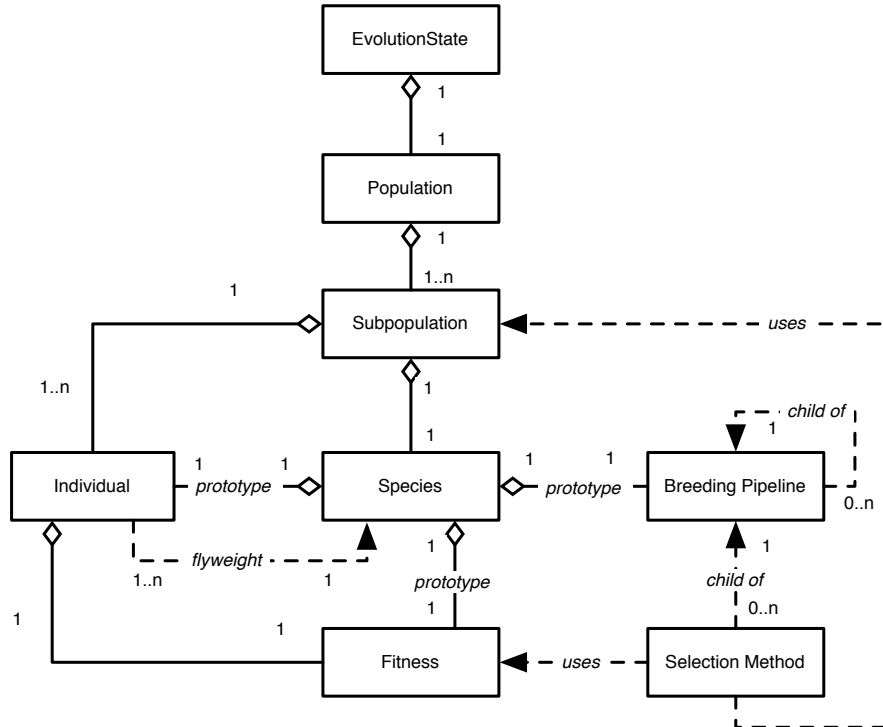

Figure 1.3 Top-Level data objects used in evolution.

Evaluation The Evaluator performs evaluation of a population by passing one or (for coevolutionary evaluation) several Individuals to a Problem subclass which the Evaluator has cloned off of its prototype. Evaluation may too be done in multithreaded fashion with no locking, using one Problem per thread. Individuals may also undergo repeated evaluation in coevolutionary Evaluators of different sorts.

In most projects using ECJ, the primary task is to construct an appropriate Problem subclass. The task of the Problem is to assess the fitness of the Individual(s) and set its Fitness accordingly. Problem classes also report if the ideal Individual has been discovered.

Utilities In addition to its ParameterDatabase, ECJ also uses a checkpointable Output convenience facility which maintains various streams, repairing them after checkpoint. Output also provides for message logging, retaining in memory all messages during the run, so that on checkpoint recovery the messages are printed out again as before. Other utilities include population distribution selectors, searching and sorting tools, etc.

The quality of a random number generator is important for a stochastic optimization system. As such, ECJ's random number generator was the very first class written in the system: it is a Java implementation of the highly respected Mersenne Twister algorithm [15] and is the fastest such implementation available. Since ECJ's release, the ECJ MersenneTwister and MersenneTwisterFast classes have found their way in a number of unrelated public-domain systems, including the popular NetLogo multiagent simulator [29]. MersenneTwisterFast is also shared in ECJ's sister software, the MASON multiagent simulation toolkit [11].

Representations and Genetic Programming ECJ allows you to specify any genome representation you like. Standard representation packages in ECJ provide functionality for vectors of all Java data types; arbitrary-length lists; trees; and collections of objects (such as rulesets).

ECJ is perhaps best known for its support of "Koza"-style tree-structured genetic programming representations. ECJ represents these individuals as forests of parse-trees, each tree equivalent to a single Lisp

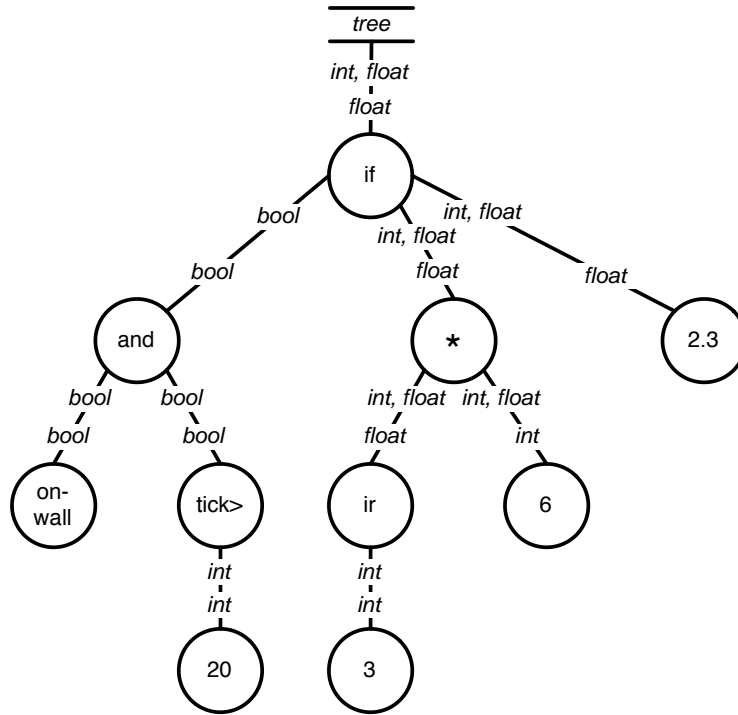

Figure 1.4 A typed genetic programming parse tree.

s-expression. Figure 1.4 shows a parse-tree for a simple robot program, equivalent to the Lisp s-expression (if (and (on-wall) (tick> 20)) (* (ir 3) 6) 2.3). In C this might look like (onWall && tick > 20) ? ir(3) * 6 : 2.3. This notionally says “If I’m on the wall and my tick-count is greater than 20, then return the value of my third infrared sensor times six, else return 2.3”. Such parse-trees are typically evaluated by executing their programs in a test environment, and modified via subtree crossover (swapping subtrees among individuals) or various kinds of mutation (replacing a subtree with a randomly-generated one, perhaps).

ECJ allows multiple subtrees for various experimental needs: Automatically Defined Functions (ADFs — a mechanism for evolving subroutine calls [7]), or parallel program execution, or evolving teams of programs. Along with ADFs, ECJ provides built-in support for Automatically Defined Macros (ADMs) [23] and Ephemeral Random Constants (ERCs [6], such as the numbers 20, 3, 6, and 2.3 in Figure 1.4).

Genetic programming trees are constructed out of a “primordial soup” of function templates (such as on-wall or 2.3. Early forms of genetic programming were typeless: though such templates had a predefined arity (number of arguments), any node could be connected to any other. Many genetic programming needs require more constraints than this. For example, the node if might expect a boolean value in its first argument, and integers or floats in the second and third arguments, and return a float when evaluated. Similarly and might take two booleans as arguments and return a boolean, while * would take ints or floats as arguments and return a float.

Such types are often associated with the kinds of data passed from node to node, but they do not have to be. Typing might be used to constrain certain nodes to be evaluated in groups or in a certain order: for example, a function type-block might insist that its first argument be of type *foo* and its second argument be of type *ar* to make certain that a *foo* node be executed before a *ar* node.

ECJ permits a simple static typing mechanism called *set-based* typing, which is suitable for many such tasks. In set-based typing, the return type and argument types of each node are each defined to be sets of type symbols (for example, {*bool*} or {*foo*, *bar*, *baz*}, or {*int*, *float*}). The desired return type for the tree’s root is

similarly defined. A child node is permitted to fit into the argument slot of a parent node if the child node's return type and type of the that argument slot in the parent are *compatible*. We define types to be compatible if their set intersection is nonempty (that is, they share at least one type symbol).

Set-based typing is sufficient for the typing requirements found in many programming languages, including ones with type hierarchies. It allows, among other things, for nodes such as *** to accept *either* integers or floats. However there are considerable restrictions on the power of set-based typing. It's often useful for the return type of a node to *change* based on the particular nodes which have plugged into it as arguments. For example, *** might be defined as returning a float if at least one of its arguments returns floats, but returning an integer if both of its arguments return integers. *if* might be similarly defined not to return a particular type, but to simply require that its return type and the second and third argument types must all match. Such "polymorphic" typing is particularly useful in situations such as matrix multiplication, where the operator must place constraints on the width and height of its arguments and the final returned matrix. In this example, it's also useful to have an infinite number of types (perhaps to represent matrices of varying widths or heights).

ECJ does not support polymorphic typing out of the box simply because it is difficult to implement many if not most common tree modification and generation algorithms using polymorphic typing: instead, set-based typing is offered to handle as many common needs as can be easily done.

Out of the Box Capabilities ECJ provides support out-of-the-box for a bunch of algorithm options:

- Generational algorithms: (μ, λ) and $(\mu + \lambda)$ Evolution Strategies, the Genetic Algorithm, Genetic Programming variants, Grammatical Evolution, PushGP, and Differential Evolution
- Steady-State evolution
- Parsimony pressure algorithms
- Spatially-embeded evolutionary algorithms
- Random restarts
- Multiobjective optimization, including the NSGA-II and SPEA2 algorithms.
- Cooperative, 1-Population Competitive, and 2-Population Competitive coevolution.
- Multithreaded evaluation and breeding.
- Parallel synchronous and asynchronous Island Models spread over a grid of computers.
- Internal synchronous Island Models internally in a single ECJ process.
- Massive parallel generational fitness evaluation of individuals on remote slave machines.
- Asynchronous Evolution, a version of steady-state evolution with massive parallel fitness evaluation on remote slave machines.
- Opportunistic Evolution, where remote slave machines run their own mini-evolutionary processes for a while before sending individuals back to the master process.
- Internal synchronous Island Models internally in a single ECJ process.
- Meta-Evolution
- A large number of selection and breeding operators

ECJ also has a GUI, though in truth I nearly universally use the command-line.

Idiosyncracies ECJ was developed near the introduction of Java and so has a lot of historical idiosyncracies.¹ Some of them exist to this day because of conservatism: refactoring is disruptive. If you code with ECJ,

¹It used to have a lot more — I've been weeding out ones that I think are unnecessary nowadays!

you'll definitely have to get used to one or more of the following:

- No generics at all, few iterators or enumerators, no Java features beyond 1.4 (including annotations), and little use of the Java Collections library. This is part historical, and part my own dislike of Java's byzantine generics implementation, but it's mostly efficiency. Generics are very slow when used with basic data types, as they require boxing and unboxing. The Java Collections library is unusually badly written in many places internally: and anyway, for speed we tend to work directly with arrays.
- Hand-rolled socket code. With one exception (optional compression), ECJ's parallel facility doesn't rely on other libraries.
- ECJ loads nearly every object from its parameter database. This means that you'll rarely see the new keyword in ECJ, nor any constructors. Instead ECJ's usual "constructor" method is a method called `setup(...)`, which sets up an object from the database.
- A proprietary logging facility. ECJ was developed before the existence of `java.util.logging`. Partly out of conservatism, I am hesitant to rip up all the pervasive logging just to use Sun's implementation (which isn't very good anyway).
- A parameter database derived from Java's old `java.util.Properties` list rather than XML. This is historical of course. But seriously, do I need a justification to avoid XML?
- Mersenne Twister random number generator. `java.lang.Random` is grotesquely bad, and systems which use it should be shunned.
- A Makefile. ECJ was developed before Ant and I've personally never needed it.

1.3 Unpacking ECJ and Using the Tutorials

ECJ is designed to be built either with **maven** or with **make**. If you build ECJ with maven, then it will package all of ECJ into a single **jar file**. If you build with **make**, you have the option of packaging into a single **jar file** or into a **directory of class files and resources**. Building to a directory is how ECJ classically was constructed, but nowadays a jar file is more useful. However even if you build to a jar file, it's still useful to have the resources and java files on-hand so you know what various ECJ applications can do and how to run them.

After unpacking ECJ, you're left with one directory called `ecj` where you will find several items:

- A top-level README.md file, which should be self-explanatory in its importance.
- ECJ's LICENSE file, which describes the primary license (AFL 3.0, a BSD-style academic license).
- A CHANGES log, which lists all past changes to all versions (including the latest).
- A Makefile for building via `make`.
- A pom.xml for building via Maven.
- The docs directory. This contains most of the ECJ documentation.
- The local-repo directory. This contains any additional libraries that maven (not make) will need to build ECJ (to build with make, you'll use a different mechanism).
- The target directory. This contains the class files, and possibly other resources (see next bullet), for ECJ after it has been built.

- The `src` directory, which contains the main Java code and the internal library test code. Of particular interest to you will be the directories `src/main/java/ec/`, which is the top-level package for ECJ, and `src/main/java/resources/ec/`. The `src/main/java/ec/` directory holds the top-level package for ECJ, `ec`. The `src/main/java/resources/ec` directory is an identical-structured directory containing various resources (notably parameter files). If you build with `make`, then these resources will get merged into the `classes` directory.

1.3.1 The `ec` Directory, the CLASSPATH, and jar files

The `ec` (`ecj/src/main/java/ec/`) directory is ECJ's top-level package. Every subdirectory is a subpackage, and most of them are headed by helpful README files which describe the contents of the directory. Most packages contain not only Java files and class files but also parameter files and occasional data files: ECJ was designed originally for the class files to be compiled and stored right alongside the Java files in these directories, though it can be used with the separate-build-area approach taken by IDEs like Eclipse.

Because `ec` is the top-level package, you can compile ECJ, more or less, by just sticking its parent directory (the `ecj/target/` directory), in your CLASSPATH. You will also need to add certain **jar files** in order to compile ECJ's distributed evaluation and island model facilities, and its GUI. You can get these jar files from the ECJ main website (<http://cs.gmu.edu/~eclab/projects/ecj/>). Note that none of these libraries is required. For example, if the libraries for the distributed evaluator and island model are missing, ECJ will compile but will complain if you try to run those packages with compression turned on (a feature of the packages). The GUI library is optional to ECJ, so if you don't install its libraries, you can still compile ECJ by just deleting the `ec/display` directory.

1.3.1.1 The `ec/display` Directory: ECJ's GUI

This directory contains ECJ's GUI. It's in a state of disrepair and I suggest you do not use it. ECJ is really best as a command line program. In fact, as mentioned above, you can simply delete the directory and ECJ will compile just fine.

1.3.1.2 The `ec/app` Directory: Demo Applications

This directory contains all the demo applications. We have quite a number of demo applications, many sharing the same subdirectories. Read the provided README file for some guidance.

1.3.2 The docs Directory

This directory contains all top-level documentation of ECJ except for the various README files scattered throughout the package. The `index.html` file provides the top-level entry point to the documentation.

The documentation includes:

- Introduction to parameters in ECJ
- Class documentation
- ECJ's four tutorials and post-tutorial discussion. The actual tutorial code is located in the `ec/app` directory.
- An (old) overview of ECJ
- An (old) discussion of ECJ's warts
- Some (old) graph diagrams of ECJ's structure
- This manual

1.3.2.1 Tutorials

ECJ has four tutorials which introduce you to the basics of coding on the system. **I strongly suggest you go through them before continuing through the rest of this manual.** They are roughly:

1. A simple GA to solve the MaxOnes problem with a boolean representation.
2. A GA to solve an integer problem, with a custom mutation pipeline.
3. An evolution strategy to solve a floating-point problem, with a custom statistics object and reading and writing populations.
4. A genetic programming problem, plus some elitism.

As should be obvious from the rest of this manual, this **barely scratches the surface** of ECJ. No mention is given of parallelism, differential evolution, coevolution, multiobjective optimization, list and ruleset representations, grammatical encoding, spatial embedding, etc. But it'll get you up to speed.

Chapter 2

ec.Evolve and Utility Classes

ECJ is big. Let us begin.

ECJ's entry point is the class `ec.Evolve`. This class is little more than bootstrapping code to set up the ECJ system, construct basic datatypes, and get things going.

To run an ECJ process, you fire up `ec.Evolve` with certain runtime arguments.

```
java ec.Evolve -file myParameterFile.params -p param=value -p param=value (etc.)
```

ECJ sets itself up entirely using a **parameter file**. To this you can add additional **command-line parameters** which override those found in the parameter file. More on the parameter file will be discussed starting in Section 2.1.

For example, if you were presently in the `ecj` directory, you could do this:

```
java ec.Evolve -file ec/app/ecsuite/ecsuite.params
```

This all assumes that the parameter file is a free-standing file in your filesystem. But it might not be: you might want to start up from a parameter file stored within a Jar file (for example if your ECJ library is bundled up into a Jar file like `ecj.jar`). To do this you can specify the parameter file as a file resource relative to the `.class` file of a class (a-la Java's `Class.getResource(...)` method):

```
java ec.Evolve -from myParameterFile.params -at relative.to.Classname -p param=value (etc.)
```

... for example:

```
java ec.Evolve -from ecsuite.params -at ec.app.ecsuite.ECSuite
```

You can also say:

```
java ec.Evolve -from myParameterFile.params -p param=value (etc.)
```

In which case ECJ will assume that the class is `ec.Evolve`. In this situation, you'd probably need to specify the parameter file as a path away from `ec.Evolve` (which is in the `ec` directory), for example:

```
java ec.Evolve -from app/ecsuite/ecsuite.params
```

(Note the missing `ec/...`). See Section 2.1 for more discussion about all this.

ECJ can also restart from a checkpoint file it created in a previous run:

```
java ec.Evolve -checkpoint myCheckpointFile.gz
```

Checkpointing will be discussed in Section 2.3.

Last but not least, if you forget this stuff, you can always type this to get some reminders:

```
java ec.Evolve -help
```

The purpose of `ec.Evolve` is to construct an `ec.EvolutionState` instance, or load one from a checkpoint file; then get it running; and finally clean up. The `ec.EvolutionState` class actually performs the evolutionary process. Most of the stuff `ec.EvolutionState` holds is associated with evolutionary algorithms or other stochastic optimization procedures. However there are certain important utility objects or data which are created by `ec.Evolve` prior to creating the `ec.EvolutionState`, and are then stored into `ec.EvolutionState` after it has been constructed. These objects are:

- The **Parameter Database**, which holds all the parameters `ec.EvolutionState` uses to build and run the process.
- The **Output**, which handles logging and writing to files.
- The **Checkpointing Facility** to create checkpoint files as the process continues.
- The **Number of Threads** to use, and the **Random Number Generators**, one per thread.
- A simple declaration of the **Number of Jobs** to run in the process.

The remainder Section 2 discusses each of these items. It's not the most exciting of topics: but it's important in order to understand the rest of the ECJ process.

2.1 The Parameter Database

To build and run an experiment in ECJ, you typically write three things:

- (In Java) A **problem** which evaluates individuals and assigns fitness values to them.
- (In Java) Depending on the kind of experiment, various **components** from which individuals can be constructed — for example, for a genetic programming experiment, you'll need to define the kinds of nodes which can be used to make up the individual's tree.
- (In one or more Parameter Files) Various **parameters** which define the kind of algorithm you are using, the nature of the experiment, and the makeup of your populations and processes.

Let's begin with the third item. Parameters are the lifeblood of ECJ: practically everything in the system is defined by them. This makes ECJ highly flexible; but it also adds complexity to the system.

ECJ loads parameter files and stores them into the `ec.util.ParameterDatabase` object, which is available to nearly everything. Parameter files are an extension of the files used by Java's old `java.util.PropertyList` object. Parameter files usually end in `".params"`, and contain parameters one to a line. Parameter files may also contain blank (all whitespace) lines, which are ignored, and also lines which start with `"#"`, which are considered comments and also ignored. An example comment:

```
# This is a comment
```

The parameter lines in a parameter file typically look like this:

```
parameter.name = parameter value
```

A **parameter name** is a string of non-whitespace characters except for "`=`". After this comes some optional whitespace, then an "`=`", then some more optional whitespace.¹ A **parameter value** is a string of characters, including whitespace, except that all whitespace is trimmed from the front and end of the string. Notice the use of a period the parameter name. It's quite a common convention to use periods in various parameter names in ECJ. We'll get to why in a second.

Here are some legal parameter lines:

```
generations = 400
pop.subpop.0.size =1000
pop.subpop= ec.Subpopulation
```

Here are some illegal parameter lines:

```
generations
= 1000
pop subpop = ec.Subpopulation
```

2.1.1 Inheritance

Parameter files may be set up to **derive from** one or more other parameter files. Let's say you have two parameter files, `a.params` and `b.params`. Both are located in the same directory. You can set up `a.params` to derive from `b.params` by adding the following line as the very first line in the `a.params` file:

```
parent.0 = b.params
```

This says, in effect: "include in me all the parameters found in the `b.params` file, but any parameters I myself declare will override any parameters of the same name in the `b.params` file." Note that `b.params` may itself derive from some other file (say, `c.params`). In this case, `a.params` receives parameters from both (and parameters in `b.params` will likewise override ones of the same name in `c.params`).

Let's say that `b.params` is located inside a subdirectory called `foo`. Then the line will look like this:

```
parent.0 = foo/b.params
```

Notice the forward slash: ECJ was designed on UNIX systems. Likewise, imagine if `b.params` was stored in a sibling directory called `bar`: then we might say:

```
parent.0 = ../bar/b.params
```

You can also define absolute paths, UNIX-style:

```
parent.0 = /tmp/myproject/foo.params
```

Long story short: parameter files are declared using traditional UNIX path syntax.

A parameter file can also derive from *multiple* parent parameter files, by including each at the beginning of the file, with consecutive numbers, like this:

```
parent.0 = b.params
parent.1 = yo/d.params
parent.2 = ../z.params
```

This says in effect: "first look in `a.params` for the parameter. If you can't find it there, look in `b.params` and, ultimately, all the files `b.params` derives from. If you can't find it in any of them, look in `d.params` and all the

¹Actually, you can omit the "`=`", but it's considered bad style.

files it derives from. If you can't find it in any of them, look in z.params and all the files it derives from. If you've still not found the parameter, give up."

This is essentially a depth-first search through a tree or DAG, with parents overriding their children (the files they derive from) and earlier siblings overriding later siblings. Note that this multiple inheritance scheme is not the same as C++ or Lisp/CLOS, which use a distance measure!

Parent parameter files can be explicit files on your file system (as shown above) or they can be files located in JAR files etc. But how do you refer to a file inside a JAR file? It's easy: refer to it using a **class relative path** (see the next Section, 2.1.2), which defines the path relative to the class file of some class. For example, suppose you're creating a parameter file whose parent is ec/app/ant/ant.params. But you're not using ECJ in its unpacked form, but rather bundled up into a JAR file. Thus ec/app/ant/ant.params is archived in that JAR file. Since this file is right next to ec/app/ant/Ant.class — the class file for the ec.app.ant.Ant class— you can refer to it as:

```
parent.0 = @ec.app.ant.Ant ant.params
```

If your parameter file is already *in* a JAR file, and it uses ordinary relative path names to refer to its parents (like ../z.params), these will be interpreted as other files in the archived file system inside that JAR file. To escape the JAR file you have to use an absolute path name, such as

```
parent.0 = /tmp/foo.params
```

It's pretty rare to need that though, and hardly good style. The whole point of JAR files is to encapsulate functionality into one package.

Overriding the Parameter File When you fire up ECJ, you point it at a single parameter file, and you can provide additional parameters at the command-line, like this:

```
java ec.Evolve -file parameterFile.params -p command-line-parameter=value \  
              -p command-line-parameter=value ...
```

Furthermore, your program itself can submit parameters to the parameter database, though it's very unusual to do so. When a parameter is requested from the parameter database, here's how it's looked up:

1. If the parameter was declared by the program itself, this value is returned.
2. Else if the parameter was provided on the command line, this value is returned.
3. Else the parameter is looked up in the provided parameter file and all derived files using the inheritance ordering described earlier.
4. Else the database signals failure.

2.1.2 Kinds of Parameters

ECJ supports the following kinds of parameters:

- **Numbers.** Either long integers or double floating-point values. Examples:

```
generations = 500  
tournament.size = 3.25  
minimum-fitness = -23.45e15
```

- **Arbitrary Strings** trimmed of whitespace. Example:

```
crossover-type = two-point
```

- **Booleans.** Any value except for "false" (case-insensitive) is considered to be *true*. It's best style to use lower-case "true" and "false". The first two of these examples are *false* and the second two are *true*:

```
print-params = false
die-a-painful-death = fAlSe
pop.subpop.0.perform-injections = true
quit-on-run-complete = whatever
```

- **Class Names.** Class names are defined as the full class name of the class, including the package. Example:

```
pop.subpop.0.species = ec.gp.GPSpecies
```

- **File or Resource Path Names.** Paths can be of four types.
 - **Absolute paths**, which (in UNIX) begin with a "/", stipulate a precise location in the file system.
 - **Relative paths**, which do not begin with a "/", are defined relative to the parameter file in which the parameter was located. If the parameter file was an actual file in the filesystem, the relative path will also be considered to point to a file. If the parameter file was in a jar file, then the relative path will be considered to point to a resource inside the same jar file relative to the parameter file location. You've seen relative paths already used for derived parameter files.
 - **Execution relative paths** are defined relative to the directory in which the ECJ process was launched. Execution relative paths look exactly like relative paths except that they begin with the special character "\$".
 - **Class relative paths** define a path relative to the class file of a class. They have two parts: the class in question, and then the path to the resource relative to it. If the class is stored in a Jar file, then the path to the resource will also be within that Jar file. Otherwise the path will point to an actual file. Class relative paths begin with "@", followed by the full class name, then spaces or tabs, then the relative path.

Examples of all four kinds of paths:

```
stat.file = $out.stat
eval.prob.map-file = ../dungeon.map
temporary-output-file = /tmp/output.txt
image = @ec.app.myapp.MyClass images/picture.png
```

If the parameter is for a file meant to be opened **read-only**, any of the four approaches above will work fine. But if the parameter is for a **writable file**, then you have an issue. As discussed in Section 2.1.4, the parameter in question could refer to a file in your operating system, or it could refer to a file bundled inside a Java jar file. In this second case, the file cannot be written to.

The only kinds of paths which can refer to things inside jar files are relative paths and class-relative paths. Thus if you stick with absolute paths or execution-relative paths, you know you'll be referring to a writable file. For this reason we recommend:

- **Read-only Files** should use class-relative paths or relative paths, and should only be accessed using `getResource(...)` (see Section 2.1.5).
 - **Read-Write Files** should use absolute paths or (in most cases) execution-relative paths, and should only be accessed using `getFile(...)` (see Section 2.1.5).
- **Arrays.** ECJ supports loading arrays of doubles,² but does not have direct support for loading arrays of other types. However it has a convention you should be made aware of. It's common for arrays to

²See the various "getDoubles" methods in Section 2.1.5.

be loaded by first stipulating the number of elements in the array, then stipulating each array element in turn, starting with 0. The parameter used for the number of elements differs from case to case. Note the use of periods prior to each number in the following example:

```
gp.fs.0.size = 6
gp.fs.0.func.0 = ec.app.ant.func.Left
gp.fs.0.func.1 = ec.app.ant.func.Right
gp.fs.0.func.2 = ec.app.ant.func.Move
gp.fs.0.func.3 = ec.app.ant.func.IfFoodAhead
gp.fs.0.func.4 = ec.app.ant.func.Progn2
gp.fs.0.func.5 = ec.app.ant.func.Progn3
```

The particulars vary. Here's another, slightly different, example:

```
exch.num-islands = 8
exch.island.0.id = SurvivorIsland
exch.island.1.id = GilligansIsland
exch.island.2.id = FantasyIsland
exch.island.3.id = TemptationIsland
exch.island.4.id = RhodeIsland
exch.island.5.id = EllisIsland
exch.island.6.id = ConeyIsland
exch.island.7.id = TreasureIsland
```

Anyway, you get the idea.

2.1.3 Namespace Hierarchies and Parameter Bases

ECJ has lots of parameters, and by convention organizes them in a namespace hierarchy to maintain some sense of order. The delimiter for paths in this hierarchy is— you guessed it— the period.

The vast majority of parameters are used by one Java object or another to set itself up immediately after it has been instantiated for the first time. ECJ has an important convention which uses the namespace hierarchy to do just this: the **parameter base**. A parameter base is essentially a path (or namespace, what have you) in which an object expects to find all of its parameters. The prefix for this path is typically the parameter name by which the object itself was loaded.

For example, let us consider the process of defining the class to be used for the global population. This class is found in the following parameter:

```
pop = ec.Population
```

ECJ looks for this parameter, expects a class (in this case, `ec.Population`), loads the class, and creates one instance. It then calls a special method (`setup(...)`, we'll discuss it later) on this class so it can set itself up from various parameters. In this case, `ec.Population` needs to know how many subpopulations it will have. This is defined by the following parameter:

```
pop.subpops = 2
```

`ec.Population` didn't know that it was supposed to look in `pop.subpops` for this value. Instead, it only knew that it needed to look in a parameter called `subpops`. The rest (in this case, `pop`) was provided to `ec.Population` as its *parameter base*: the text to be prepended— plus a period— to all parameters that `ec.Population` needed to set itself up. It's not a coincidence that the parameter base also happened to be the very parameter which defined `ec.Population` in the first place. This is by convention.

Armed with the fact that it needs to create an array of two subpopulations, `ec.Population` is ready to load the classes for those two subpopulations. Let's say that for our experiment we want them to be of different classes. Here they are:

```
pop.subpop.0 = ec.Subpopulation
pop.subpop.1 = ec.app.myapp.MySpecialSubpopulation
```

The two classes are loaded and one instance is created of each of them. Then `setup(...)` is called on each of them. Each subpopulation looks for a parameter called `size` to tell it how many individuals will be in that subpopulation. Since each of them is provided with a different parameter base, they can have different sizes:

```
pop.subpop.0.size = 100
pop.subpop.1.size = 512
```

Likewise, each of these subpopulations needs a “species”. Presuming that the species are different classes, we might have:

```
pop.subpop.0.species = ec.vector.VectorSpecies
pop.subpop.1.species = ec.gp.GPSpecies
```

These species objects themselves need to be set up, and when they do, their parameter bases will be `pop.subpop.0.species` and `pop.subpop.1.species` respectively. And so on.

Now imagine that we have ten subpopulations, all of the same class (`ec.Subpopulation`), and *all but the first one* has the exact same size. We’d wind up having to write silly stuff like this:

```
pop.subpop.0.size = 1000
pop.subpop.1.size = 500
pop.subpop.2.size = 500
pop.subpop.3.size = 500
pop.subpop.4.size = 500
pop.subpop.5.size = 500
pop.subpop.6.size = 500
pop.subpop.7.size = 500
pop.subpop.8.size = 500
pop.subpop.9.size = 500
```

That’s a lot of typing. Though I am saddened to report that ECJ’s parameter files *do* require a lot of typing, at least the parameter database facility offers an option to save our fingers somewhat in this case. Specifically, when the `ec.Subpopulation` class sets itself up each time, it actually looks in not one but *two* path locations for the `size` parameter: first it tacks on its current base (as above), and if there’s no parameter at that location, then it tries tacking on a **default base** defined for its class. In this case, the default base for `ec.Subpopulation` is the prefix `ec.subpop`. Armed with this we could simply write:

```
ec.subpop.size = 500
pop.subpop.0.size = 1000
```

When ECJ looks for subpopulation 0’s size, it’ll find it as normal (1000). But when it looks for subpopulation 1 (etc.), it won’t find a `size` parameter in the normal location, so it’ll look in the default location, and use what it finds there (500). Only if there’s no parameter to be found in either location will ECJ signal an error.

It’s important to note that if a class is loaded from a default parameter, this doesn’t mean that the default parameter will become its parameter base: rather, the original expected location will continue to be the base. For example, imagine if both of our Species objects were the same class, and we had defined them using the default base. That is, instead of

```
pop.subpop.0.species = ec.vector.VectorSpecies
pop.subpop.1.species = ec.vector.VectorSpecies
```

...we simply said

```
ec.subpop.species = ec.vector.VectorSpecies
```

When the species for subpopulation 0 is loaded, its parameter base is not going to be `ec.subpop.species`. Instead, it will still be `pop.subpop.0.species`. Likewise, the parameter base for the species of subpopulation 1 will still be `pop.subpop.1.species`.

Keep in mind that all of this is *just a convention*. You can use periods for whatever you like ultimately. And there exist a few global parameters without any base at all. For example, the number of generations is defined as

```
generations = 200
```

...and the seed for the random number generator the fourth thread is

```
seed.3 = 12303421
```

...even though there is *no object set up* with the seed parameter, and hence no object has seed as its parameter base. Random number generators are one of the few rare objects in ECJ which are not specified from the parameter file.

2.1.4 Parameter Files in Jar Files

Parameter files don't have to be just in your file system: they can be bundled up in jar files. If a parameter file is being read from a jar file, its parents will be generally assumed to be from the same jar file as well if they're relative paths (they don't start with `'/'` in UNIX).

So how do you point to a parameter file in a jar file to get things rolling? You can run ECJ like this:

```
java ec.Evolve -from parameterFile.params -at relative.class.Name ...
```

This instructs ECJ to look for the `.class` file of the class `relative.class.Name`, be it in the file system or in a Jar file. Once ECJ has found it, it looks for the path `parameterFile.params` relative to this file. You can omit the classname, which causes ECJ to assume that the class in question is `ec.Evolve`. For example, to run the Ant demo from ECJ (in a Jar file or unpacked into the file system), you could say:

```
java ec.Evolve -from app/ant/ant.params
```

Notice it does not say `ec/app/ant/ant.params`, which is probably what you'd expect if you used `"-file"` rather than `"-from"`. This is because ECJ goes to the `ec/Evolve.class` file, then from there it searches for the parameter file. The path of the parameter file relative to the `ec/Evolve.class` file is `app/ant/ant.params`.

There are similar rules regarding file references (such as parent references) within a parameter file. Let's say that your parameter file is inside a jar file. If you say something like:

```
parent.0 = ../path/to/the/parent.params
```

... then ECJ will look around *inside the same Jar file* for this file, rather than externally in the operating system's file system or in some other Jar file.

You can escape this however. For example, once your parameter file is inside a Jar file, you can still define a parent in *another* Jar file, or in the file system, if you know a another class file it's located relative to. You just need to specify another class for ECJ to start at, and a path relative to it, like this:

```
parent.0 = @ec.foo.AnotherClass relative/path/to/the/parent.params
```

See the next section for more explanation of that text format.

Last but not least, once your parameter file is in a Jar file, you can refer to a parent in the file system if you use an absolute path (that is, one which (in UNIX anyway) starts with `'/'`). For example:

```
parent.0 = /Users/sean/myexperiment/other.params
```

Absolute path names aren't very portable and aren't recommended.

2.1.5 Accessing Parameters

Parameters are looked up in the `ec.util.ParameterDatabase` class, and parameter names are specified using the `ec.Parameter` class. The latter is little more than a cover for Java strings. To create the parameter `pop.subpop.0.size`, we say:

```
Parameter param = new Parameter("pop.subpop.0.size");
```

Of course, usually we don't want to just make a direct parameter, but rather want to construct one from a parameter base and the remainder. Let's say our base (`pop.subpop.0`) is stored in the variable `base`, and we want to look for `size`. We do this as:

```
Parameter param = base.push("size");
```

Here are some common `ec.util.ParameterDatabase` methods. Note that all of them look in two places to find a parameter value. This is what we use to handle "standard" and "default" bases. Typically you'd pass in the parameter in its standard location, and also (in the "default parameter") parameter with its default base configuration. You can pass in null for either, and it'll get ignored.

`ec.util.ParameterDatabase` Methods

```
public boolean exists(Parameter parameter, Parameter default)
```

If either parameter exists in the database, return true. Either parameter may be null.

```
public String getString(Parameter parameter, Parameter default)
```

Look first in *parameter*, then failing that, in *default parameter*, and return the result as a String, else null if not found. Either parameter may be null.

```
public String getStringWithDefault(Parameter parameter, Parameter default, String defaultValue)
```

Look first in *parameter*, then failing that, in *default parameter*, and return the result as a String, else *defaultValue* if not found. Either parameter may be null.

```
public File getFile(Parameter parameter, Parameter default)
```

Look first in *parameter*, then failing that, in *default parameter*, and return the result as a File, else null if not found. Either parameter may be null. **Important Note.** You should generally only use this method if you are *writing* to a file. Otherwise it's best if you used `getResource(...)`.

```
public InputStream getResource(Parameter parameter, Parameter default)
```

Look first in *parameter*, then failing that, in *default parameter*, and open an InputStream to the result, else null if not found. Either parameter may be null. **Important Note.** This is distinguished from `getFile(...)` in that the object doesn't have to be a file in the file system: it can for example be a location in a jar file. If the parameter specifies an absolute path or an execution relative path, then a file in the file system will be opened. If the parameter specifies a relative path, and the parameter database was itself loaded as a file rather than a resource (in a jar file say), then a file will be opened, else a resource will be opened in the same jar file as the parameter file. You can also specify a resource path directly.

```
public Object getInstanceForParameterEq(Parameter parameter, Parameter default, Class superclass)
```

Look first in *parameter*, then failing that, in *default parameter*, to find a class. The class must have *superclass* as a superclass, or can be the *superclass* itself. Instantiate one instance of the class using the default (no-argument) constructor, and return the instance. Throws an `ec.util.ParamClassLoadException` if no class is found.

```
public Object getInstanceForParameter(Parameter parameter, Parameter default, Class superclass)
```

Look first in *parameter*, then failing that, in *default parameter*, to find a class. The class must have *superclass* as a

superclass, but may not be *superclass* itself. Instantiate one instance of the class using the default (no-argument) constructor, and return the instance. Throws an `ec.util.ParamClassLoadException` if no class is found.

`public int getBoolean(Parameter parameter, Parameter default, double defaultValue)`

Look first in *parameter*, then failing that, in *default parameter*, and return the result as a boolean, else *defaultValue* if not found or not a boolean. Either parameter may be null.

`public int getIntWithDefault(Parameter parameter, Parameter default, int defaultValue)`

Look first in *parameter*, then failing that, in *default parameter*, and return the result as an int, else *defaultValue* if not found or not an int. Either parameter may be null.

`public int getInt(Parameter parameter, Parameter default, int minValue)`

Look first in *parameter*, then failing that, in *default parameter*, and return the result as an int, else *minValue*-1 if not found, not an int, or < *minValue*. Either parameter may be null.

`public int getIntWithMax(Parameter parameter, Parameter default, int minValue, int maxValue)`

Look first in *parameter*, then failing that, in *default parameter*, and return the result as an int, else *minValue*-1 if not found, not an int, < *minValue*, or > *maxValue*. Either parameter may be null.

`public long getLongWithDefault(Parameter parameter, Parameter default, long defaultValue)`

Look first in *parameter*, then failing that, in *default parameter*, and return the result as a long, else *defaultValue* if not found or not a long. Either parameter may be null.

`public long getLong(Parameter parameter, Parameter default, long minValue)`

Look first in *parameter*, then failing that, in *default parameter*, and return the result as a long, else *minValue*-1 if not found, not a long, or < *minValue*. Either parameter may be null.

`public long getLongWithMax(Parameter parameter, Parameter default, long minValue, long maxValue)`

Look first in *parameter*, then failing that, in *default parameter*, and return the result as a long, else *minValue*-1 if not found, not a long, < *minValue*, or > *maxValue*. Either parameter may be null.

`public float getFloatWithDefault(Parameter parameter, Parameter default, float defaultValue)`

Look first in *parameter*, then failing that, in *default parameter*, and return the result as a float, else *defaultValue* if not found or not a float. Either parameter may be null.

`public float getFloat(Parameter parameter, Parameter default, float minValue)`

Look first in *parameter*, then failing that, in *default parameter*, and return the result as a float, else *minValue*-1 if not found, not a float, or < *minValue*. Either parameter may be null.

`public float getFloatWithMax(Parameter parameter, Parameter default, float minValue, float maxValue)`

Look first in *parameter*, then failing that, in *default parameter*, and return the result as a float, else *minValue*-1 if not found, not a float, < *minValue*, or > *maxValue*. Either parameter may be null.

`public double getDoubleWithDefault(Parameter parameter, Parameter default, double defaultValue)`

Look first in *parameter*, then failing that, in *default parameter*, and return the result as a double, else *defaultValue* if not found or not a double. Either parameter may be null.

`public double getDouble(Parameter parameter, Parameter default, double minValue)`

Look first in *parameter*, then failing that, in *default parameter*, and return the result as a double, else *minValue*-1 if not found, not a double, or < *minValue*. Either parameter may be null.

`public double getDoubleWithMax(Parameter parameter, Parameter default, double minValue, double maxValue)`

Look first in *parameter*, then failing that, in *default parameter*, and return the result as a double, else *minValue*-1 if not found, not a double, < *minValue*, or > *maxValue*. Either parameter may be null.

`public double getDoubles(Parameter parameter, Parameter default, double minValue)`

Look first in *parameter*, then failing that, in *default parameter*, for a space- or tab-delimited list of double values, and return the result as an array of doubles, else null if they are improperly formatted or if any of them is < *minValue*, or if the list is zero in length, or if it has garbage at the end of it. Either parameter may be null.

2.1.6 Parameter Macros

The `get()` method can also handle special *macro parameters*. Macro parameter names will end in **alias**, which means you *cannot have any parameter names which end with this word*. The idea behind a macro parameter is that it can substitute one substring for another among your parameter names, making your parameters potentially much simpler. Macros work along period boundaries.

2.1.6.1 The Alias Macro

The **alias** parameter macro works as follows. Let's say that you have:

```
hello.there.alias = foo
```

This means to replace `hello.there` with `foo` and continue looking up the parameter. For example, when you query for the parameter

```
hello.there.mom.how.are.you
```

it is converted to the parameter

```
foo.mom.how.are.you
```

which is then looked up in the database. Furthermore

```
hello.there.partner
```

is converted to the parameter

```
foo.partner
```

and

```
hello.there
```

is converted to just the parameter

```
foo
```

Which are then looked up in the database. Conflicting rules are handled in order of specificity. For example, if you had

```
hello.there.alias = foo
hello.there.mom.alias = bar
hello.there.mom.how.are.you = whoa
hello.there.brother = hey
```

Now let's say we queried

```
hello.there.dad
```

This would get converted to

```
foo.dad
```

which would then get looked up. But if we queried

```
hello.there.mom.42
```

Then our second rule would take precedence, because it's more specific, and instead of converting to `foo.mom.42` we would instead convert to

```
bar.42
```

which would then get looked up. Finally, if we queried

```
hello.there.mom.how.are.you
```

Then this would take precedence and the system would immediately return `whoa`. Furthermore, if we queried

```
hello.there.brother
```

This would immediately return `hey`, because exact parameters take precedence over macros.

Additionally note that the substitution is delimited by the periods. So querying

```
hello.there.whoa
```

will *not* get translated. And furthermore the substitution must start at the start of the parameter name, so querying

```
my.hello.there.mom
```

will also *not* get translated.

Beware of cycles! For example, if you have

```
a.b.alias = foo
foo.alias = a.b
```

... and you query

```
a.b.yo
```

... you should get an error reported and null returned.

2.1.7 Debugging Your Parameters

Your ECJ experiment is loading and running, but how do you know you didn't make a mistake in your parameters? How do you know ECJ is using the parameters you stated rather than some default values? If you include the following parameter in your collection:

```
print-params = true
```

...then ECJ will print out all the parameters which were used or tested for existence. For example, you might get things like this printed out:

```

!P: pop.subpop.0.file
P: pop.subpop.0.species = ec.gp.GPSpecies
<P: ec.subpop.species
P: pop.subpop.0.species.pipe = ec.breed.MultiBreedingPipeline
<P: gp.species.pipe
!E: pop.subpop.0.species.pipe.prob
P: pop.subpop.0.species.pipe.num-sources = 2
<P: breed.multibreed.num-sources
P: pop.subpop.0.species.pipe.source.0 = ec.gp.koza.CrossoverPipeline
<P: breed.multibreed.source.0
E: pop.subpop.0.species.pipe.source.0.prob = 0.9
<E: gp.koza.xover.prob

```

A **P** means that a parameter value was accessed (or attempted to). An **E** means that a parameter was tested for existence. An **!** means that the parameter did not exist. A **<** means that the parameter existed in the default base as well as the primary base, but the value of the primary base was the one used. In this last case, the primary base is printed out on the line immediately prior.

There are a few other debugging parameters of less value. At the end of a run, ECJ can dump all the parameters in the database; all the parameters accessed (retrieved or tested for existence); all the parameters used (retrieved); all the parameters *not* accessed; and all the parameters *not* used. Pick your poison. Here are the relevant parameters:

```

print-all-params = true
print-accessed-params = true
print-used-params = true
print-unaccessed-params = true
print-unused-params = true

```

Typically you'd only want to set one of these to true. The most useful one is `print-unaccessed-params`, since by examining the results you can see if a parameter you set was used or not: if not, probably because it wasn't typed right. It also tells you about old, disused parameters. In fact, as I was writing this manual and needed `print-unaccessed-params` examples, I ran the Lawnmower problem (in `ec/app/lawnmower`) and got the following:

```

Unaccessed Parameters
===== (Ignore parent.x references)

gp.fs.2.info = ec.gp.GPFuncInfo
gp.koza.grow.min-depth = 5
gp.tc.0.init.max = 6
gp.koza.mutate.build.0 = ec.gp.koza.GrowBuilder
gp.tc.1.init.max = 6
parent.0 = ../../gp/koza/koza.params
gp.koza.grow.max-depth = 5
gp.tc.2.init.max = 6
gp.koza.mutate.ns.0 = ec.gp.koza.KozaNodeSelector
gp.fs.0.info = ec.gp.GPFuncInfo
gp.koza.half.growp = 0.5
gp.tc.0.init.min = 2
gp.koza.mutate.source.0 = ec.select.TournamentSelection
gp.koza.mutate.tries = 1
gp.tc.1.init.min = 2
gp.fs.1.info = ec.gp.GPFuncInfo
gp.tc.2.init.min = 2
gp.koza.mutate.maxdepth = 17

```

Most of these unaccessed parameters are perfectly fine; standard boilerplate stuff for genetic programming that didn't happen to be used by this application. But then there's the first parameter: `gp.fs.2.info = ec.gp.GPFuncInfo`, and two others like it later. I had deleted the `GPFuncInfo` class from the ECJ distribution well over a *year ago*. But apparently I forgot to remove a vestigial parameter which referred to it. Oops!

By the way, note the request to ignore "parent.x references"—this means to ignore the stuff like `parent.0 = ../../gp/koza/koza.params` that gets printed out with everything else.

For more on debugging ECJ, see Section 3.8.

2.1.8 Building a Parameter Database from Scratch

This is starting to get inside-baseball, so you may wish to skip it for now. Normally `ParameterDatabase` is constructed from the `Evolve` class on your behalf. But in some unusual situations you may need to build one yourself. Most notably, if you're attaching ECJ as a sub-module under some application or toolkit (see Section 2.7), you may need to make a custom `ParameterDatabase` with which to run ECJ.

A typical `ParameterDatabase` is constructed from a file or a resource relative to a class. When this is done, what you receive is an empty `ParameterDatabase` which points to another `ParameterDatabase`. The empty `ParameterDatabase` is free for you to modify. For example, if you call...

```

File file = ...
String[] commandLineArguments = ...
ParameterDatabase db = new ParameterDatabase(file, commandLineArguments);

```

... you will get back an empty `ParameterDatabase` whose parent is a `ParameterDatabase` holding the commands-line arguments, whose parent is a `ParameterDatabase` constructed from the file. That final `ParameterDatabase` may have further parents as specified in the file itself.

Other `ParameterDatabase` constructors, particularly ones which do not concern themselves with specific files, will not have this feature.

The particular chain, if there is one at all, varies depending on the constructor you call. The one in the example above is the most common constructor.

ec.util.ParameterDatabase Constructor Methods

`public ParameterDatabase()`

Creates a simple empty parameter database with no parents. The database hierarchy is simply: `empty`

`public ParameterDatabase(Dictionary map)`

Creates a parameter database with the given Dictionary. Both the keys and values will be run through `toString()` before adding to the database. Keys are parameters. Values are the values of the parameters. If parents are defined in the map's parameters, they will be attempted to be loaded: only parents which are absolute path names are permitted. Beware that a `ParameterDatabase` is itself a Dictionary; but if you pass one in here you will only get the lowest-level elements. The database hierarchy is: `map` → ... Note that unlike other methods, this method does not create an empty base parameter database. If you want a hierarchy like `empty` → `map` → ... you can achieve this with `new ParameterDatabase().addParent(new ParameterDatabase(myMap))`

`public ParameterDatabase(InputStream stream)`

Creates a parameter database by reading parameters from the provided stream. If parents are defined among the parameters, they will be attempted to be loaded: only parents which are absolute path names are permitted. Beware that a `ParameterDatabase` is itself a Dictionary; but if you pass one in here you will only get the lowest-level elements. The database hierarchy is: `stream` → ... Note that unlike other methods, this method does not create an empty base parameter database. If you want a hierarchy like `empty` → `stream` → ... you can achieve this with `new ParameterDatabase().addParent(new ParameterDatabase(myStream))`

`public ParameterDatabase(File file)`

Creates a new parameter database from the given file (and possibly parent files). The database hierarchy is: `empty` → `file` → ...

`public ParameterDatabase(File file, String[] args)`

Creates a new parameter database from the given file (and possibly parent files). The database hierarchy is: `empty` → `args` → `file` → ...

`public ParameterDatabase(String pathNameRelativeToClassFile, Class cls)`

Creates a new parameter database from the given file (and possibly parent files). The file is located a path name relative to object (.class) file of the provided class. For example, if the class were `Foo`, and its object file was located at `/a/b/Foo.class`, and the path name relative to the class file was `../c/bar.params`, then the file would be expected to be located at `/a/c/bar.params`. This also works inside jar files. The database hierarchy is:

`empty` → `pathNameRelativeToClassFile` → ...

`public ParameterDatabase(String pathNameRelativeToClassFile, Class cls, String[] args)`

Creates a new parameter database from the given file (and possibly parent files). The file is located a path name relative to object (.class) file of the provided class. For example, if the class were `Foo`, and its object file was located at `/a/b/Foo.class`, and the path name relative to the class file was `../c/bar.params`, then the file would be expected to be located at `/a/c/bar.params`. This also works inside jar files. The database hierarchy is:

`empty` → `args` → `pathNameRelativeToClassFile` → ...

Once you have created a `ParameterDatabase`, you can attach parent `ParameterDatabases` to it. You can also set values in the `ParameterDatabase`, and remove values (though you cannot remove values from its parents without accessing the parents themselves), among other operations.

ec.util.ParameterDatabase Methods

`public void addParent(ParameterDatabase database)`

Adds a parent database to the parameter database.

```
public void set(Parameter parameter, String value)
    Sets a parameter in the immediate parameter database. This overrides settings in parents. The value is first
    trimmed of whitespace.

public void remove(Parameter parameter)
    Removes a parameter from an immediate parameter database (but not from its parents in the hierarchy).

public ParameterDatabase getLocation(Parameter parameter)
    Returns the parameter database in the parent hierarchy which defined the currently-used value for the given
    parameter.

public String getLabel()
    Returns a string describing the location of the ParameterDatabase (such as the file name from which it was
    loaded), or the empty string if there is nothing appropriate.
```

2.2 Output

ECJ has its own idiosyncratic logging and output facility called `ec.util.Output`. This is largely historical: ECJ predates any standard logging facilities available in Java. The facility is in part inspired by a similar facility that existed in the **lil-gp** C-based genetic programming system. The system has generally worked out well so we've not seen fit to replace it.

The primary reason for the central logging and output facility is to survive checkpointing and restarting from checkpoints (see Section 2.3). Except for the occasional debugging statement which we've forgotten to remove, all output in ECJ goes through `ec.util.Output`.

The output facility has four basic features:

- **Logs**, attached to Files or to Writers, which output text of all kinds. Logs can be *restarted*, meaning that they can be reopened when ECJ is restarted from a checkpoint.
- Two dedicated Logs, the **Message Logs**, which write text out to stdout and stderr respectively.
- The ability to print arbitrary text to any Log.
- Short **Announcements** of different kinds. Announcements are different from arbitrary text in that they are not only written out to Logs (usually the stderr message Log) but are also stored in memory. This allows them to be checkpointed and automatically reposted after ECJ has started up again from a checkpoint.

The least important announcements are simple **messages**. One special kind of message is the **system message** generated by ECJ itself. Next in importance are **warnings**. One special kind of warning, the **once-only-warning**, will be written only once to a Log even if it's posted multiple times. Next are basic **errors**. Things can be configured such that after a bunch of errors, ECJ will quit. Finally, **fatal errors** will cause ECJ to quit immediately rather than wait for more errors to accumulate.

2.2.1 Creating and Writing to Logs

There are many methods in `ec.util.Output` for creating or accessing Logs. Here are some common ones:

ec.util.Output Methods

```
public int addLog(File file, boolean appendOnRestart)
    Add a log on a given file. If ECJ is restarted from a checkpoint, and appendOnRestart is true, then the log will be
    appended to the current file contents. Else they will be replaced. The Log is registered with ec.util.Output and its
    log number is returned.
```

```
public int addLog(File file, boolean appendOnRestart, boolean gzip)
    Add a log on a given file. If ECJ is restarted from a checkpoint, and appendOnRestart is true, then the log will be
    appended to the current file contents. Else they will be replaced. If gzip is true, then the log will be gzipped. You
    cannot have both appendOnRestart and gzip true at the same time. The Log is registered with ec.util.Output and its
    log number is returned.

public Log getLog(int index)
    Returns the log indexed at the given location.

public int numLogs()
    Returns the total number of logs.
```

Two logs are always made for you automatically: a log to **stdout** (log index 0); and another log to **stderr** (log index 1). The `stderr` log prints all announcements, but the `stdout` log does not.

Logs have various instance variables, but few are important, except for this one:

```
public boolean silent = false;
```

If you set this flag to true, the log will not print anything at all. See section 2.2.2 for more information on how to do this.

To write arbitrary text to a log, here are the most common methods:

ec.util.Output Methods

```
public void print(String text, int log number)
    Prints a string to a log.

public void println(String text, int log number)
    Prints a string to a log, plus a newline.
```

Besides `stdout` (0) and `stderr` (1), there are two other special log numbers you should be aware of:

```
public int ALL_MESSAGE_LOGS;
public int NO_LOGS;
```

`NO_LOGS` is a special log value meaning “don’t bother printing this”. It’s sometimes used to turn off printing to certain logs temporarily. `ALL_MESSAGE_LOGS` will cause printing to be sent to all logs for which message logging is turned on. By default that’s just `stderr` (1). This is not commonly used. To post a message or generate a warning or error (all of which ordinarily go to the `stderr` log, and are also stored in memory):

ec.util.Output Methods

```
public void message(String text)
    Posts a message.

public void warning(String text)
    Posts a warning.

public void warning(String text, Parameter parameter, Parameter default)
    Posts a warning, and indicates the parameters which caused the warning. Typically used for cautioning the user
    about the parameters he chose.

public void warnOnce(String text)
    Posts a warning which will not appear a second time.

public void warnOnce(String text, Parameter parameter, Parameter default)
    Posts a warning which will not appear a second time, and indicates the parameters which caused the warning.
    Typically used for cautioning the user about the parameters he chose.
```

```
public void error(String text)
    Posts an error message. The contract implied in using this method is that at some point in the near future you will call exitIfErrors().
```

```
public void error(String text, Parameter parameter, Parameter default)
    Posts an error message, and indicates the parameters which caused the warning. Typically used for cautioning the user about the parameters he chose. The contract implied in using this method is that at some point in the near future you will call exitIfErrors().
```

```
public void exitIfErrors()
    Exits immediately if an error has been posted.
```

```
public void fatal(String text)
    Posts an error message and exits immediately.
```

```
public void fatal(String text, Parameter parameter, Parameter default)
    Posts an error message, indicates the parameters which caused the warning, and exits immediately. Typically used for cautioning the user about the parameters he chose.
```

2.2.2 Quieting the Program

ECJ prints a lot of stuff to the screen (both `stdout` and `stderr`) when doing its work. Perhaps you'd like to shut ECJ up. It's easy. If you set the following parameter:

```
silent = true
```

... then ECJ will eliminate both of its `stdout` and `stderr` logs, so nothing will be printed to the screen.

This parameter doesn't prevent ECJ statistics objects from writing to various file logs. However many statistics objects have similar options to quiet them. See Sections 3.7.3 and 7.5.0.2.

2.2.3 The `ec.util.Code` Class

ECJ Individuals, Fitnesses, and various other components sometimes need to write themselves to a file in a way which can *both* be read by humans *and* be read back into Java resulting in perfect copies of the original. This means that neither printing text nor writing raw data binary is adequate.

ECJ provides a utility facility to make doing this task a little simpler. The `ec.util.Code` class encodes and decodes basic Java data types (booleans, bytes, shorts, ints, longs, floats, chars, Strings) into Strings which can be emitted as text. They all have the same pattern:

`ec.util.Code` Methods

```
public static String encode(boolean val)
    Encodes val into a String and returns it.
```

```
public static String encode(byte val)
    Encodes val into a String and returns it.
```

```
public static String encode(short val)
    Encodes val into a String and returns it.
```

```
public static String encode(int val)
    Encodes val into a String and returns it.
```

```
public static String encode(long val)
    Encodes val into a String and returns it.
```

public static String encode(float val)
Encodes *val* into a String and returns it.

public static String encode(double val)
Encodes *val* into a String and returns it.

public static String encode(char val)
Encodes *val* into a String and returns it.

public static String encode(String val)
Encodes *val* into a String and returns it. Obviously encoding a String into a String sounds goofy, but go with us here.

These methods encode their data in an idiosyncratic way. Here's a table describing it:

Data Type	Encoding	Example
boolean	T or F	T
byte	<i>bvalueAsDecimalNumber</i>	b59
short	<i>svalueAsDecimalNumber</i>	s-321
int	<i>ivalueAsDecimalNumber</i>	i42391
long	<i>lvalueAsDecimalNumber</i>	l-342341232
float	<i>fvalueEncodedAsInteger</i> <i>valuePrintedForHumans</i>	f-665866527 -9.1340002E14
double	<i>dvalueEncodedAsLong</i> <i>valuePrintedForHumans</i>	d4614256656552045848 3.141592653589793
char	' <i>characterWithEscapes</i> '	'w' or ' ' or '\n' or '\'
String	" <i>stringWithEscapes</i> "	"Dragon in Chinese is:\n\u2FD3"

These are of course idiosyncratic,³ but lacking a Java standard for doing the same task, they do an adequate job. You're more than welcome to go your own way.

2.2.3.1 Decoding the Hard Way

To decode a sequence of values from a String, you begin by creating an `ec.util.DecodeReturn` object wrapped around the String:

```
DecodeReturn decodeReturn = new DecodeReturn(string);
```

To decode the next item out of the string, you call:

```
Code.decode(decodeReturn);
```

The type of the decoded data is stored here:

```
int type = decodeReturn.type;
```

... and is one of the following `ec.util.DecodeReturn` constants:

³The eccentricities in this class stem from it being developed well before Java had any standard way to do such things itself — indeed Java still doesn't have a standard way to do most of this. I might improve it in the future, at the very least, by not requiring type symbols (like `b`) in front of integer types. And including methods named things like `DecodeReturn.getFloat()` which throws exceptions rather than requiring one to look up type information.

```

public static final byte DecodeReturn.T_ERROR = -1;
public static final byte DecodeReturn.T_BOOLEAN = 0;
public static final byte DecodeReturn.T_BYTE = 1;
public static final byte DecodeReturn.T_CHAR = 2;
public static final byte DecodeReturn.T_SHORT = 3;
public static final byte DecodeReturn.T_INT = 4;
public static final byte DecodeReturn.T_LONG = 5;
public static final byte DecodeReturn.T_FLOAT = 6;
public static final byte DecodeReturn.T_DOUBLE = 7;
public static final byte DecodeReturn.T_STRING = 8;

```

If the type is a boolean (false = 0, true = 1), byte, char, short, int, or long, the result is stored here:

```
long result = decodeReturn.l;
```

If the type is a double or float, the result is stored here:

```
double result = decodeReturn.d;
```

If the type is a String, the result is stored here:

```
String result = decodeReturn.s;
```

To decode the next element out of the String, just call `Code.decode(decodeReturn)` again. Continue doing this until you're satisfied or reach a type of `T_ERROR`.

2.2.3.2 Decoding the Easy Way

One of the most common decoding tasks is reading a decoded number or boolean from a single line, often preceded with a preamble, such as:

```
Evaluated: T
```

... Or ...

```
Size of Genome: i13|
```

The `Code` class has some convenience methods for decoding these lines without having to muck about with a `DecodeReturn`:

ec.util.Code Methods

```
public static float readFloatWithPreamble(String preamble, EvolutionState state, LineNumberReader reader)
    Decodes and returns an encoded single floating-point value from the reader, first skipping past an expected preamble. If the preamble does not exist, or the value does not exist, an error is issued.
```

```
public static float readDoubleWithPreamble(String preamble, EvolutionState state, LineNumberReader reader)
    Decodes and returns an encoded double floating-point value from the reader, first skipping past an expected preamble. If the preamble does not exist, or the value does not exist, an error is issued.
```

```
public static float readBooleanWithPreamble(String preamble, EvolutionState state, LineNumberReader reader)
    Decodes and returns an encoded boolean value from the reader, first skipping past an expected preamble. If the preamble does not exist, or the value does not exist, an error is issued.
```

```
public static byte readByteWithPreamble(String preamble, EvolutionState state, LineNumberReader reader)
    Decodes and returns an encoded byte from the reader, first skipping past an expected preamble. If the preamble does not exist, or the value does not exist, an error is issued.
```

```
public static short readShortWithPreamble(String preamble, EvolutionState state, LineNumberReader reader)
    Decodes and returns an encoded short from the reader, first skipping past an expected preamble. If the preamble
    does not exist, or the value does not exist, an error is issued.

public static float readIntegerWithPreamble(String preamble, EvolutionState state, LineNumberReader reader)
    Decodes and returns an encoded integer from the reader, first skipping past an expected preamble. If the preamble
    does not exist, or the value does not exist, an error is issued.

public static long readLongWithPreamble(String preamble, EvolutionState state, LineNumberReader reader)
    Decodes and returns an encoded long from the reader, first skipping past an expected preamble. If the preamble
    does not exist, or the value does not exist, an error is issued.

public static char readCharacterWithPreamble(String preamble, EvolutionState state, LineNumberReader reader)
    Decodes and returns an encoded character from the reader, first skipping past an expected preamble. If the
    preamble does not exist, or the value does not exist, an error is issued.

public static char readStringWithPreamble(String preamble, EvolutionState state, LineNumberReader reader)
    Decodes and returns an encoded string from the reader, first skipping past an expected preamble. If the preamble
    does not exist, or the value does not exist, an error is issued.
```

2.3 Checkpointing

ECJ supports **checkpointing**, meaning the ability to save the state of the stochastic optimization process to a file at any point in time, and later start a new ECJ process resuming at that exact state. Checkpointing is particularly useful when doing long processes on shared servers or other environments where the process may be killed at any time. ECJ's checkpointing procedure largely consists of applying Java's serialization mechanism to the `ec.EvolutionState` object, which in turn serializes the entire object graph of the current system.

Turn on checkpointing like this:

```
checkpoint = true
```

ECJ typically writes out checkpoint files every n generations (or, in the steady-state evolution situation, every n generations' worth of evaluations of individuals). To set $n = 4$, you'd say:

```
checkpoint-modulo = 4
```

ECJ writes to checkpoint files named `ec.generation.gz`, where *generation* is the current generation number. If you don't like the `ec` prefix for some reason, change it to, say, `curmudgeon` like this:

```
checkpoint-prefix = curmudgeon
```

By default ECJ writes checkpoints to the directory in which you had run Java. But you can set a parameter to specify a directory to which checkpoints should be written, such as `/tmp/`:

```
checkpoint-directory = /tmp/
```

This directory can be an absolute, relative, execution relative, or class relative path (see Section 2.1.2 for a refresher). But it *must* be a directory, not a file.

Whenever a checkpoint is written, this fact is also added as an announcement. Here's the output of a typical run with checkpointing every two generations.

```
| ECJ
| An evolutionary computation system (version 19)
```



```
| By Sean Luke
| Contributors: L. Panait, G. Balan, S. Paus, Z. Skolicki, R. Kicing, E. Popovici,
|               K. Sullivan, J. Harrison, J. Bassett, R. Hubley, A. Desai, A. Chircop,
|               J. Compton, W. Haddon, S. Donnelly, B. Jamil, and J. O'Beirne
| URL: http://cs.gmu.edu/~eclab/projects/ecj/
| Mail: ecj-help@cs.gmu.edu
|       (better: join ECJ-INTEREST at URL above)
| Date: July 10, 2009
| Current Java: 1.5.0_20 / Java HotSpot(TM) Client VM-1.5.0_20-141
| Required Minimum Java: 1.4
```

```
Threads: breed/1 eval/1
Seed: -530434079
Job: 0
Setting up
Initializing Generation 0
Subpop 0 best fitness of generation: Fitness: -1542.1932
Generation 1
Subpop 0 best fitness of generation: Fitness: -1499.354
Checkpointing
Wrote out checkpoint file ec.2.gz
Generation 2
Subpop 0 best fitness of generation: Fitness: -1497.0482
Generation 3
Subpop 0 best fitness of generation: Fitness: -1481.9377
Checkpointing
Wrote out checkpoint file ec.4.gz
Generation 4
Subpop 0 best fitness of generation: Fitness: -1426.816
...
```

Imagine that at this point the power failed and we lost the process. We'd like to start again from the checkpoint file ec.4.gz. We can do that by typing:

```
java ec.Evolve -checkpoint ec.4.gz
```

Notice that we don't provide a parameter file or optional command-line parameters. That's because the parameter database has already been built and stored inside the checkpoint file. When ECJ starts up from a checkpoint file, it starts right where it left off, but first spits out all the announcements that had been produced up to that point, with one exception. See if you can catch it:

Restoring from Checkpoint ec.4.gz

```
| ECJ
| An evolutionary computation system (version 19)
| By Sean Luke
| Contributors: L. Panait, G. Balan, S. Paus, Z. Skolicki, R. Kicing, E. Popovici,
|               K. Sullivan, J. Harrison, J. Bassett, R. Hubley, A. Desai, A. Chircop,
|               J. Compton, W. Haddon, S. Donnelly, B. Jamil, and J. O'Beirne
| URL: http://cs.gmu.edu/~eclab/projects/ecj/
| Mail: ecj-help@cs.gmu.edu
|       (better: join ECJ-INTEREST at URL above)
| Date: July 10, 2009
| Current Java: 1.5.0_20 / Java HotSpot(TM) Client VM-1.5.0_20-141
| Required Minimum Java: 1.4
```

```

Threads:  breed/1 eval/1
Seed: -530434079
Job: 0
Setting up
Initializing Generation 0
Subpop 0 best fitness of generation: Fitness: -1542.1932
Generation 1
Subpop 0 best fitness of generation: Fitness: -1499.354
Checkpointing
Wrote out checkpoint file ec.2.gz
Generation 2
Subpop 0 best fitness of generation: Fitness: -1497.0482
Generation 3
Subpop 0 best fitness of generation: Fitness: -1481.9377
Checkpointing
Generation 4
Subpop 0 best fitness of generation: Fitness: -1426.816
Generation 5
Subpop 0 best fitness of generation: Fitness: -1336.0835
Checkpointing
Wrote out checkpoint file ec.6.gz
Generation 6
Subpop 0 best fitness of generation: Fitness: -1302.0063
...

```

2.3.1 Implementing Checkpointable Code

ECJ's checkpoint facility relies on Java's serialization package. When ECJ checkpoints, it serializes the `EvolutionState`. Since *everything* in an ECJ run is hanging off of the `EvolutionState` somewhere, the entire ECJ run is serialized out to disk.

Checkpointing is fragile. When you write your code, here are some good practices you should follow:

- Add to each of your classes the following instance variable:

```
private static final long serialVersionUID = 1;
```

- Try to avoid non-static inner classes. But if you must have one, it should also have the aforementioned instance variable in *its* variables as well.
- All static variables should be final and should be simple types, such as Strings, ints, floats, etc. If you need to store global information, it should be stored as an instance variable in your subclass of `EvolutionState`.
- Don't allocate your own threads or locks.
- If you make a special object, it must be `java.io.Serializable`. Most ECJ classes are already serializable, so you inherit this by just subclassing from them.

Checkpointing is normally done after breeding has occurred, and the generation number has been incremented. Three things typically happen:

1. The `preCheckpointStatistics(...)` method is called on the statistics object.
2. The `setCheckpoint(...)` method is called on the checkpoint object. This causes the checkpoint object to serialize out the current `EvolutionState` to a gzipped checkpoint file.

3. The `postCheckpointStatistics(...)` method is called on the statistics object.

When the system is restored from a checkpoint, the following happens:

1. The `restoreFromCheckpoint(...)` method is called on the `Checkpoint` class. This method does the following:
 - (a) It first unserializes the `EvolutionState` from the checkpoint file.
 - (b) It then calls `resetFromCheckpoint(...)` on the `EvolutionState`. The `resetFromCheckpoint` method normally does two things:
 - i. `restart(...)` is called on the `Output`. This allows it to set up output logs again.
 - ii. `reinitializeContacts(...)` is called on the `Exchanger`, then on the `Evaluator`, to allow them to reestablish network connections for distributed evaluation and for island models.
2. Evolution is resumed by calling the `run(...)` method on the unserialized `EvolutionState`.
3. `startFromCheckpoint(...)` is then called on the `EvolutionState`. This is a simple hook method you can use to set up things before evolution starts again.

At this point, evolution continues.

In general you have two hooks available to you to set up after resuming from a checkpoint. First, you can override the method `EvolutionState.resetFromCheckpoint()`. This method is called before `EvolutionState.run(...)` is called to resume running. You would override this method to reopen files or sockets (it optionally throws an `IOException`).

Second, you could override the method `EvolutionState.startFromCheckpoint()`. This method is called during `EvolutionState.run(...)`, typically immediately before the run resumes. You would typically override this method to do internal setup that doesn't involve external communication.

In either case, be sure to call the supermethod first.

2.4 Threads and Random Number Generation

In many cases ECJ supports multiple threads at two stages of the evolutionary process: during *breeding* and during *evaluation*. You can specify the number of threads for each of these processes like this:

```
breedthreads = 4
evalthreads = 4
```

Typically, but not always, you'd want to set these numbers to match the number of cores or processors on your computer. And usually these two numbers should be the same. If you don't know the number of cores, you can let ECJ try to figure it out for you by saying:

```
breedthreads = auto
evalthreads = auto
```

ECJ is still capable of producing replicable results even when threading is turned on: you'll get the same results if you use the same number of evaluation and breeding threads and the same random number generator seeds. Which brings us to...

2.4.1 Random Numbers

As befitting its name, stochastic optimization is *stochastic*, meaning involving randomness. This means that a random number generator is central to the algorithms in ECJ, and it's crucial to have a fairly good generator. Unfortunately, Java's default random number generator, `java.util.Random`, is notoriously bad. It

creates highly nonrandom sequences, so much so that websites have been developed to show off how awful it is.⁴ **Never, ever, use `java.util.Random` in your ECJ code.**

ECJ comes with a high quality random number generator ready for you to use: `ec.util.MersenneTwisterFast`. This is a fast implementation of a famous random number generator, the Mersenne Twister.⁵ The Mersenne Twister has a very high period and good statistical randomness qualities.

If you're comfortable with `java.util.Random`, you'll be fine. `ec.util.MersenneTwisterFast` has all the methods that `java.util.Random` has, plus one or two more.

In ECJ, Mersenne Twister is seeded with a single 32-bit integer other than zero (actually, it's a long, but only the first 32 bits are used).⁶ You specify this seed with the following parameter:

```
seed.0 = -492341
```

Setting the seed this way gives you control over ECJ's results: if you set the seed to the same value, ECJ will produce the exact same results again. But if you like you can also let ECJ set the seed to the current wall clock time in milliseconds, which is almost always different for different runs:

```
seed.0 = time
```

One reason ECJ's Mersenne Twister implementation is fairly fast is that it's not threadsafe. Thus ECJ maintains one random number generator for each thread used by the program. This means that if you have more than one thread, you'll have more than one random number generator, and each one of them will need a seed. Let's say you've settled on two threads. You can set both random number generator seeds like this:

```
evalthreads = 2
breedthreads = 2
seed.0 = -492341
seed.1 = 93123
```

You can also use wall clock time. Specifically, if you instead do the following:

```
evalthreads = 2
breedthreads = 2
seed.0 = time
seed.1 = time
```

...ECJ will guarantee that the two seeds differ. Last, if you set your threads automatically:

```
evalthreads = auto
breedthreads = auto
```

...then ECJ will automatically set all the seeds using wall clock time, except the ones you specify by hand. After all, you don't know how many seeds you'll get!

The Mersenne Twister random number generators are stored in an array, located in a variable called `random` in the `ec.EvolutionState` object. The size of the array is the maximum of the number of breed and evaluation threads being used. How do you know which random number generator you should use? Many methods in ECJ are passed a **thread number**. This number is the index into the random number generator array for the thread in which this method is being called. For example, to get a random double, you typically see things along these lines:

```
double d = state.random[threadnum].nextDouble();
```

If you're in a single-threaded portion of the program, you can just use generator number 0.

⁴See for example <http://alife.co.uk/nonrandom/>

⁵<http://www.math.sci.hiroshima-u.ac.jp/~m-mat/MT/emt.html>

⁶Actually, Mersenne Twister can be seeded with its full internal state: an array of over 600 integers. But it's pretty rare to need this, and you'd have to do it programmatically in the random number generator rather than as an ECJ parameter.

Any gotchas? Yes. The standard MT199937 seeding algorithm uses one of Donald Knuth's plain-jane linear congruential generators to fill the Mersenne Twister's arrays. This means that for a short while the algorithm will initially be outputting a (very slightly) lower quality random number stream until it warms up. After about 625 calls to the generator, it'll be warmed up sufficiently. You probably will never notice or care, but if you wanted to be extra extra paranoid, you could call `nextInt()` 1300 times or so when your model is initially started. Perhaps in the future we'll do that for you.

`MersenneTwisterFast` (which ECJ uses) and its sibling `MersenneTwisterFast` have identical methods to `java.util.Random`, plus one or two more for good measure. They should look familiar to you:

ec.util.MersenneTwisterFast Constructor Methods

`public MersenneTwisterFast(long seed)`

Seeds the random number generator. Note that only the first 32 bits of the seed are used.

`public MersenneTwisterFast()`

Seeds the random number generator using the current time in milliseconds.

`public MersenneTwisterFast(int[] vals)`

Seeds the random number generator using the given array. Only the first 624 integers in the array are used. If the array is shorter than 624, then the integers are repeatedly used in a wrap-around fashion (not recommended). The integers can be anything, but you should avoid too many zeros. MASON does not call this method.

ec.util.MersenneTwisterFast Methods

`public void setSeed(long seed)`

Seeds the random number generator. Note that only the first 32 bits of the seed are used.

`public void setSeed(int[] vals)`

Seeds the random number generator using the given array. Only the first 624 integers in the array are used. If the array is shorter than 624, then the integers are repeatedly used in a wrap-around fashion (not recommended). The integers can be anything, but you should avoid too many zeros.

`public double nextDouble()`

Returns a random double drawn in the half-open interval from [0.0, 1.0). That is, 0.0 may be drawn but 1.0 will never be drawn.

`public double nextDouble(boolean includeZero, boolean includeOne)`

Returns a random double drawn in interval from 0.0 to 1.0, possibly including 0.0 or 1.0 or both, as specified in the arguments.

`public float nextFloat()`

Returns a random float drawn in the half-open interval from [0.0f, 1.0f). That is, 0.0f may be drawn but 1.0f will never be drawn.

`public float nextFloat(boolean includeZero, boolean includeOne)`

Returns a random float drawn in interval from 0.0f to 1.0f, possibly including 0.0f or 1.0f or both, as specified in the arguments.

`public double nextGaussian()`

Returns a random double drawn from the standard normal Gaussian distribution (that is, a Gaussian distribution with a mean of 0 and a standard deviation of 1).

`public long nextLong()`

Returns a random long.

`public long nextLong(long n)`

Returns a random long drawn from between 0 to $n - 1$ inclusive.

```
public int nextInt()
    Returns a random integer.

public int nextInt(int n)
    Returns a random integer drawn from between 0 to  $n - 1$  inclusive.

public short nextShort()
    Returns a random short.

public char nextChar()
    Returns a random character.

public byte nextByte()
    Returns a random byte.

public void nextBytes(byte[] bytes)
    Fills the given array with random bytes.

public boolean nextBoolean()
    Returns a random boolean.

public boolean nextBoolean(float probability)
    Returns a random boolean which is true with the given probability, else false. Note that you must carefully pass in
    a float here, else it'll use the double version below (which is twice as slow).

public boolean nextBoolean(double probability)
    Returns a random boolean which is true with the given probability, else false.

public Object clone()
    Clones the generator.

public boolean stateEquals(Object o)
    Returns true if the given Object is a MersenneTwisterFast and if its internal state is identical to this one.

public void writeState(DataOutputStream stream)
    Writes the state to a stream.

public void readState(DataInputStream stream)
    Reads the state from a stream as written by writeState(...).

public static void main(String[] args)
    Performs a test of the code.
```

2.4.2 Selecting Randomly from Distributions

Selecting from distributions is a common task in stochastic optimization.⁷ ECJ has a utility class, `ec.util.RandomChoice`, which makes it easy to set up and select from histogram-style (arbitrary) distributions, such as selecting randomly from a Population by Fitness.

The distributions in question come in the form of arrays of floats, doubles, or special objects which can provide their own float or double values. The values in these arrays are expected to form a probability density function (PDF). The objective is to select indexes in this array proportional to their value. To begin, you call one of the following methods on your array to have `RandomChoice` convert it into a Cumulative Density Function (CDF) to make selection easier:

`ec.util.RandomChoice` Methods

⁷These are just histogram distributions. If what you need is to pick random numbers under some mathematical distribution (Poisson, say), ECJ doesn't have support for that. However ECJ's sister package, MASON, has support for it in its utilities. See MASON's `sim.util.distribution` package. You can remove this package from MASON and just use it with ECJ with no problems: it comes with MASON but is independent of it. See <http://cs.gmu.edu/~eclab/projects/mason/>

```

public static void organizeDistribution(float[] probabilities, boolean allowAllZeros)
    If the array is all zeros, then if allowAllZeroes is false, then an ArithmeticException is thrown, else the array is converted to all ones. Then the array is converted to a CDF. If the array has negative numbers or is of zero length, an Arithmetic Exception is thrown.

public static void organizeDistribution(float[] probabilities)
    If the array is all zeros, then if allowAllZeroes is false, then an ArithmeticException is thrown. If not, then the array is converted to a CDF. If the array has negative numbers or is of zero length, an Arithmetic Exception is thrown.

public static void organizeDistribution(double[] probabilities, boolean allowAllZeros)
    If the array is all zeros, then if allowAllZeroes is false, then an ArithmeticException is thrown, else the array is converted to all ones. Then the array is converted to a CDF. If the array has negative numbers or is of zero length, an Arithmetic Exception is thrown.

public static void organizeDistribution(double[] probabilities)
    If the array is all zeros, then if allowAllZeroes is false, then an ArithmeticException is thrown. If not, then the array is converted to a CDF. If the array has negative numbers or is of zero length, an Arithmetic Exception is thrown.

public static void organizeDistribution(Object[] objs, RandomChoiceChooser chooser, boolean allowAllZeros)
    The objects in objs ae passed to chooser to provide their floating-point values (and to set them if needed). If the array is all zeros, then if allowAllZeroes is false, then an ArithmeticException is thrown, else the array is converted to all ones. Then the array is converted to a CDF. If the array has negative numbers or is of zero length, an Arithmetic Exception is thrown.

public static void organizeDistribution(Object[] objs, RandomChoiceChooser chooser)
    The objects in objs ae passed to chooser to provide their floating-point values (and to set them if needed). If the array is all zeros, then if allowAllZeroes is false, then an ArithmeticException is thrown. Then the array is converted to a CDF. If the array has negative numbers or is of zero length, an Arithmetic Exception is thrown.

public static void organizeDistribution(Object[] objs, RandomChoiceChooserD chooser, boolean allowAllZeros)
    The objects in objs ae passed to chooser to provide their double-floating-point values (and to set them if needed). If the array is all zeros, then if allowAllZeroes is false, then an ArithmeticException is thrown, else the array is converted to all ones. Then the array is converted to a CDF. If the array has negative numbers or is of zero length, an Arithmetic Exception is thrown.

public static void organizeDistribution(Object[] objs, RandomChoiceChooserD chooser)
    The objects in objs ae passed to chooser to provide their double-floating-point values (and to set them if needed). If the array is all zeros, then if allowAllZeroes is false, then an ArithmeticException is thrown. Then the array is converted to a CDF. If the array has negative numbers or is of zero length, an Arithmetic Exception is thrown.

```

These methods rely on two special interfaces, **RandomChoiceChooser** (ec.util.RandomChoiceChooser) and **RandomChoiceChooserD** (ec.util.RandomChoiceChooserD). RandomChoiceChooser requires two method which map between Objects and floating-point values.

```

public float getProbability(Object obj);
public void setProbability(Object obj, float probability);

```

RandomChoiceChooserD is the same, except that it's used for double values:

```

public double getProbability(Object obj);
public void setProbability(Object obj, double probability);

```

Once the array has been modified, you can then select random indexes from it. This is done by first generating a random floating-point number from 0...1, then passing that number into one of the following methods.

ec.util.RandomChoice Methods

```

public static int pickFromDistribution(float[ ] probabilities, float probability)
    Selects and returns an index in the given array which contains the given probability.

public static int pickFromDistribution(double[ ] probabilities, double probability)
    Selects and returns an index in the given array which contains the given probability.

public static int pickFromDistribution(Object[ ] objs, RandomChoiceChooser chooser, float probability)
    Selects and returns an index in the given array which contains the given probability. The chooser will provide the
    floating-point values of each element in the array.

public static int pickFromDistribution(Object[ ] objs, RandomChoiceChooserD chooser, double probability)
    Selects and returns an index in the given array which contains the given probability. The chooser will provide the
    floating-point values of each element in the array.

```

2.4.3 Thread-Local Storage

In certain rare cases you might need your threads to be able to stash away temporary information on a per-thread basis. To do this, ECJ has an array of hash tables, one per thread number (indexed just like the random number generators are). You can use these as you like, though we suggest you use them to store information you need hashed under a unique string name special to your task. The hash tables are located in `EvolutionState` and are called:

```
public HashMap[] data;    // one hash table per thread number
```

These serve roughly the same purpose as Java's `ThreadLocal` variables, but we can use an array here instead of a `ThreadLocal` because we know beforehand how many threads we have.

2.4.4 Multithreading Support

ECJ not only can evaluate and breed individuals in a multithreaded fashion, but it also uses multiple threads in other areas, such as handling island models or distributed parallel evaluation on remote machines. Many of these ECJ modules take advantage of a *thread pool*, essentially a cache of hot threads, so they don't have to create new ones on-the-fly all the time. This could have been done with Java's concurrency package; but ECJ has its own lightweight thread pool called `ec.util.ThreadPool`.

You can hand the `ThreadPool` a `java.lang.Runnable`, and it will fire off this `Runnable` in a separate thread, either drawn from the `ThreadPool` or (if none are available) created new. `ThreadPool` returns to you a `ec.util.ThreadPool.Worker` which represents that thread. When your `Runnable` has completed its task, the `Worker` will return to the `ThreadPool` to be used later. You can also wait for a specific `Worker` to complete its `Runnable` (a task known as *joining*); or wait for all currently running `Workers` to complete their `Runnable`s. You can also kill `Workers` not presently running a `Runnable`, or join all `Workers` and then kill everyone. Overall it's a very simple, lightweight API.

ec.util.ThreadPool Methods

```

public Worker start(Runnable run)
    Starts a Worker's thread on a given Runnable and returns that Worker. This Worker and its thread are drawn from
    the pool, or if there is no available Worker, it is created new (with a new thread).

public Worker start(Runnable run, String name)
    Starts a Worker's thread on a given Runnable and returns that Worker. The thread will be named with the given
    name so it is easily recognized in a debugger. This Worker and its thread are drawn from the pool, or if there is no
    available Worker, it is created new (with a new thread).

public int getTotalWorkers()
    Returns the total number of workers either waiting in the pool or presently working on some Runnable.

```



```

public int getPooledWorkers()
    Returns the total number of workers waiting in the pool (not working on some Runnable).

public boolean join(Worker thread, Runnable run)
    Blocks until the given Worker has completed running the given Runnable, then returns true. If the Worker is not
    running this Runnable, returns false immediately.

public boolean join(Worker thread)
    Blocks until the given Worker has completed running any current Runnable, then returns true. If the Worker is not
    any Runnable, returns false immediately.

public void joinAll()
    Blocks until all Workers have completed running any current Runnables.

public void killPooled()
    Destroys all currently pooled Workers (that is, ones which are not running a Runnable).

public void killAll()
    Blocks until all Workers have completed running any current Runnables. Then destroys all Workers.

```

A Worker encapsulates a running thread, and is intentionally very opaque. However you can send an interrupt to the underlying thread if you need to (a rare need):

ec.util.ThreadPool.Worker Methods

```

public void interrupt()
    Calls interrupt() on the Worker's underlying thread.

```

2.5 Jobs

Perhaps you need to run ECJ 50 times and collect statistics from all 50 runs. ECJ's `ec.Evolve` class provides a rudimentary but extensible jobs facility to do this. You specify the number of jobs as follows:

```
jobs = 50
```

Each job will automatically use a different set of random number generator seeds. Additionally, if there is more than one job, ECJ will prepend each statistics file with `job.jobnumber`. For example, if we ran with just a single job (the default) we'd probably create an output statistics file called `out.stat`. But if we ran with multiple jobs, during the fourth job we'd create the output statistics file as `job.3.out.stat` (jobs start with 0).

Jobs are restarted properly from checkpoints: when you resume from a checkpoint, you'll start up right in that job and continue from there. This is accomplished by storing the job parameter, and the runtime arguments, in the `ec.EvolutionState` object. See extended comments in the `ec.Evolve` source code for more information.

But what if you need more job complexity? For example, what if you want to run ECJ with 10 different parameter settings and 50 runs per setting? You'll need to do some coding.

For example, let's say we want to run 50 jobs, and each job changes the generation length. The first job has 20 generations, the second job has 21 generations, etc. Here's the trick. After ECJ creates the `ec.EvolutionState` object, it calls the `startFresh()` method on this object. The default implementation calls `setup(...)` on this object, then starts running the evolutionary loop. There's your chance. Let's say you're using the common `EvolutionState` `ec.simple.SimpleEvolutionState` subclass as your `EvolutionState`. Override the `startFresh(...)` method in a custom subclass of `SimpleEvolutionState` along these lines:

```

public class ec.app.myexample.MySimpleEvolutionState extends ec.simple.SimpleEvolutionState
{
    public void startFresh()
    {
        // setup() hasn't been called yet, so very few instance variables are valid at this point.
        // Here's what you can access: parameters, random, output, evalthreads, breedthreads,
        //                               randomSeedOffset, job, runtimeArguments, checkpointPrefix,
        //                               checkpointDirectory
        // Let's modify the 'generations' parameter based on the job number
        int jobNum = ((Integer)(job[0])).intValue();
        parameters.set(new ec.util.Parameter("generations"), "" + (jobNum + 20));

        // call super.startFresh() here at the end. It'll call setup() from the parameters
        super.startFresh();
    }
}

```

Now we need to stipulate that this is our EvolutionState, by changing the state parameter:

```

state = ec.app.myexample.MySimpleEvolutionState
jobs = 50

```

In truth though, in all my experiments, I have personally *always* handled different parameter settings in a completely different way: on the command line using a UNIX script. It's much simpler than mucking with Java code. For example, to run ten runs each of five different population sizes, perhaps you could do this (in the tcsh shell language):

```

@ seed = 92341
foreach size (2 4 8 16 32)
    foreach job (1 2 3 4 5 6 7 8 9 10)
        @ seed = ${seed} + 17
        java ec.Evolve -file ant.params \
            -p seed.0=${seed} \
            -p pop.subpop.0.size=${size} \
            -p stat.file=out.${size}.${job}.stat
    end
end

```

2.6 The ec.Evolve Top-level

ECJ's Evolve.java class looks complex but that's just because it has various gizmos to do jobs, checkpoint handling, etc. But in fact, the top-level loop for ECJ can be quite small. Here's all you need to do:

1. Try to load an ec.EvolutionState from a checkpoint file.
2. If it loads call run(...) on it.
3. Otherwise...
 - (a) Load a parameter database.
 - (b) Create a new ec.EvolutionState from the parameter database.
 - (c) Call run(...) on it.
4. Call cleanup(...) and exit.

Here's the basic code. As you can see, it's not very complex.

```
public static void main(String[] args)
{
    EvolutionState state = Evolve.possiblyRestoreFromCheckpoint(args);
    if (state!=null) // loaded from checkpoint
        state.run(EvolutionState.C_STARTED_FROM_CHECKPOINT);
    else
    {
        ParameterDatabase parameters = Evolve.loadParameterDatabase(args);
        state = Evolve.initialize(parameters, 0);
        state.run(EvolutionState.C_STARTED_FRESH);
    }
    Evolve.cleanup(state);
    System.exit(0);
}
```

The source code for `ec.Evolve` is very heavily commented with examples and ideas for customization. Check it out!

The `ec.Evolve` class is the most common way to start up ECJ but it's just a bootstrapping mechanism and can be completely replaced with code of your own. However there are a number of useful utility methods in the class which you might want to take advantage of even if you decide to roll your own bootstrapper.

ec.Evolve Methods

`public static void main(String[] args)`

The top-level. Starts up ECJ either from a checkpoint file (by calling `possiblyRestoreFromCheckpoint(...)`) or from scratch (by calling `initialize(...)`), runs the EC process, then finally calls `cleanup(...)`.

`public static EvolutionState possiblyRestoreFromCheckpoint(String[] args)`

If the command-line arguments indicate that ECJ should load an `EvolutionState` from a checkpoint file, this method does so and returns it. Else it returns null.

`public static ParameterDatabase loadParameterDatabase(String[] args)`

Loads a `ParameterDatabase` from the file or resource indicated on the command line.

`public static EvolutionState initialize(ParameterDatabase parameters, int randomSeedOffset)`

Builds a new `EvolutionState` and initializes it, using the provided random seed offset. This method simply calls `buildOutput()`, then calls `initialize(parameters, randomSeedOffset, output)`.

`public static Output buildOutput()`

Builds a new `Output` and returns it.

`public static EvolutionState initialize(ParameterDatabase parameters, int randomSeedOffset, Output output)`

Builds a new `EvolutionState` and initializes it, using the provided `Output` and random seed offset. The random seed is determined by first drawing it from the command line, then adding the random seed offset multiplied by the number of random number generators (e.g., threads). Thus the `randomSeedOffset` can be used to indicate a job number. For example, if there are two random number generators and the base seed was 1234, and there are three jobs, then the first (zeroth) job will have generators 1234 and 1235, the second job will have generators 1236 and 1237, and the third job will have 1238 and 1239. If you're not doing jobs, just pass in 0 for the offset.

`public static int determineThreads(Output output, ParameterDatabase parameters, Parameter threadParameter)`

Looks up the given thread parameter and, using it, determines the number of threads to use.

`public static int determineSeed(Output output, ParameterDatabase parameters, Parameter seedParameter, long currentTime, int offset, boolean auto)`

Computes a random number generator seed. The seed is computed by first looking up `seedParameter` and using this as the base seed. If the seed parameter is "time", or `auto` is true, then the provided current time is used as a base seed (you might wish to change the time each time you call this method). Otherwise, the base seed is the number value stored in the seed parameter. Then the base seed plus the offset is returned as the final seed.

```
public static MersenneTwisterFast primeGenerator(MersenneTwisterFast generator)
    Mersenne Twister's first 624 or so random numbers are not as good as its later numbers because they were
    constructed using a Knuth LCS generator to initialize Mersenne Twister from a seed. They're acceptable to use but
    just to be careful, this method "primes the pump" by calling nextInt() 1048 times, then returns the same generator.

public static void cleanup(EvolutionState state)
    Flushes and closes output buffers and writes out used, accessed, unused, and unaccessed parameters as requested.
```

2.7 Integrating ECJ with other Applications or Libraries

When integrating ECJ with other applications or libraries, you have to decide who's going to be in the driver's seat — that is, in control of `main(...)`. There are two common situations:

- **ECJ is in control.** The most common scenario here is ECJ using an external library, such as a simulation toolkit, to assess the fitness of an Individual.
- **The other application or library is in control.** This might arise if you have some external application which wishes to use ECJ as a sub-procedure to do some optimization.

You can of course do both: have Application A control ECJ, which in turn controls Simulation Library B.

2.7.1 Control by ECJ

When ECJ is in control, usually the subordinate library is being used to assess the quality of an Individual, perhaps as a simulation library. To do this, you'll probably need a place to set up your library, prepare a simulation to test a string of Individuals, reset the simulation for each Individual, and eventually destroy the library. Note that if you use checkpointing, your library must be serializable.

Let's do the simplest case: it may well be the case that all you need to do is create a simulation, run it, and destroy it each time an individual is evaluated. In this case, you just do this inside the `evaluate()` method in your Problem, along these lines:

```
public void evaluate(EvolutionState state, Individual ind, int subpopulation, int threadnum)
{
    if (!ind.evaluated) // don't bother reevaluating
    {
        // Build the simulation
        Simulation mySimulation = new Simulation(state.random[threadnum], threadnum, ...);

        // use the simulation, then get rid of it
        // then set the fitness of the individual
    }
}
```

Notice that in this example, to construct our simulation, we're passing in the random number generator for the thread, which would be the best practice. We're also passing in the thread number, which is a unique integer from 0 ... `state.evalthreads`), which might be useful for the simulation to distinguish itself from others (for example, so it can write out some kind of statistics file as "foo.threadnumber.out" or whatever so none of the simulations overwrite each other).

You need to be careful about random number generators. The best thing to do would be to use ECJ's generator. But here's the order of options, from best to least good.

1. The best would be for simulator #thread to use `state.random[thread]` as its only random number generator.
2. If this is not possible, next best would be for each simulator to use a *unique* random number generator object. This may not result in replicable results.
3. If this is not possible, next best would be for each simulator to use a *shared* random number generator object which is synchronized for multithreading. This will *definitely* not result in replicable results, and may also not be properly serializable.
4. If your simulator is using `java.util.Random` or (heaven forbid) `Math.random(...)`, then it's time for a rewrite of your simulator.

Note also that if you use distributed evaluation, this code will be run on remote machines, so you'd want to do this stuff on the **slave**, not on the **master**.

Finally, remember that if you run multithreaded, you'll have multiple simulations running in parallel, and you'll want to make sure that these simulations don't share any global (static) data in common that would create race conditions.

This approach is plausible but it's a bit inflexible and inefficient. You are given no opportunity to globally set up the simulation system, and furthermore you're constructing and destroying an entire simulation each time — perhaps it would be better to:

1. Load and set up the simulation library once
2. Use this to construct some N simulations, one per thread, once, or perhaps once per generation
3. Reuse these simulations multiple times by resetting them (rather than destroying and recreating them) when new individuals need to be assessed
4. Clean up before quitting

Here are some plausible locations for these tasks:

Set up the library I would create a custom `EvolutionState`, and override `setup()` to create a blank array of simulations, one per evaluation thread. This would also be the spot to set up the library as appropriate. Note that `setup()` is called even on the master when you're doing distributed evaluation, but in that case you'd not want to set up since you're not doing any simulations on the master. So the code below checks for that.

```
public class MyEvolutionState extends ec.simple.SimpleEvolutionState // or whatever...
{
    public Simulation[] simulations;

    public void setup(EvolutionState state, Parameter base)
    {
        super.setup(state, base); // state is obviously the MyEvolutionState itself

        // there are two cases where we'd want to set this up:
        // 1. I am running ECJ in a single process, and am NOT running with
        //    distributed (master/slave) evaluation
        // 2. I am running with distributed evaluation, and I am a slave (not the master).
        // So we check for those cases here:

        // the code below verifies that I'm running on a slave, not the master
        ec.util.Parameter param = new ec.util.Parameter("eval.i-am-slave");
        boolean amASlave = state.parameters.getBoolean(param, null, false);
    }
}
```

```

// the code below verifies that I'm doing distributed evaluation
boolean doingDistributedEvaluation = (Evaluator.masterProblem == null);

// okay here we go
if (!doingDistributedEvaluation || amASlave)
    {
        simulations = new Simulation[state.evalthreads];

        // do your library setup here
        // now create the simulation array
    }
}

```

You'd then set this parameter:

```
state = MyEvolutionState
```

You could of course override the `setup(...)` method of certain other classes, such as `ec.Initializer` (see Section 3.3).

It's possible that you might need to differentiate between setting up from a fresh run and setting up due to recovering from checkpoint. In this case, you might instead override the methods `startFresh()` and `startFromCheckpoint()`. See Section 3.

Prepare the simulation and evaluate an individual Whenever `evaluate(...)` is called, you can now grab your simulation, reset it as appropriate, and test your individual. Alternatively you could just delete your existing simulation and create a new fresh one:

```

public void evaluate(EvolutionState state, Individual ind, int subpopulation, int thread)
    {
        if (simulations[thread] == null) // simulator doesn't exist
            simulations[thread] = new Simulation(state.random[thread], thread, ...);
        else simulations[thread].reset(); // reset your simulator somehow

        // run the simulation with your individual and assess the individual
        // now set its fitness here
    }

```

Alternatively of course you could always just make a new simulation if that's not terribly inefficient.

Now you'd set up the simulation with your ECJ individual, pulse it multiple times until you're finished, and then determine the Individual's Fitness and return.

Alternatively if your Problem implements the coevolutionary `ec.coevolve.GroupedProblemForm` (see Section 7.1.2), you might write this:

```

public void evaluate(EvolutionState state, Individual[] ind, boolean[] updateFitness,
                    boolean countVictoriesOnly, int[] subpops, int thread)
    {
        if (simulations[thread] == null) // simulator doesn't exist
            simulations[thread] = new Simulation(state.random[thread], thread, ...);
        else simulations[thread].reset(); // reset your simulator somehow

        // run the simulation with all individuals in ind[] and assess them
    }

```

```
// now set their fitnesses here
}
```

At the end of a run, ECJ may call the `describe()` method on your `Problem` (see Section 3.4.1). I'd do things similarly:

```
public void describe(EvolutionState state, Individual ind, int subpopulation, int thread, int log)
{
    if (simulations[thread] == null) // simulator doesn't exist
        simulations[thread] = new Simulation(state.random[thread], thread, ...);
    else simulations[thread].reset(); // reset your simulator somehow

    // run the simulation with your individual and write out to the log interesting facts
}
```

At present there is no `describe(...)` method for `GroupedProblemForm`.

Optionally Delete the Simulation each Generation It's possible that you might want to clean delete your simulation or clean it up somehow after a generation has transpired. This is an unusual need: I wouldn't do this. But if you must, you could do this in your `Problem` class:

```
public void finishEvaluating(EvolutionState state, int thread)
{
    super.finishEvaluating(state, thread);

    // do your cleanup here of simulations[thread], then...
    simulations[thread] = null;
}
```

See again Section 3.4.1.

Clean up the Library Finally at the end of an ECJ run you can clean up the library if you need to: perhaps to flush out logs or close sockets. A reasonable place to do this is to create a custom `ec.Finisher` subclass (see Section 3.3):

```
public class MyFinisher extends SimpleFinisher // or whatever
{
    public void finishPopulation(EvolutionState state, int result)
    {
        super.finishPopulation(state, result);

        // clean up the simulations

        for(int simID = 0; simID < state.evalthreads; simID++)
        {
            if (simulations[simID] != null)
            {
                // clean up simulations[simID] as you wish, then...
                simulations[simID] = null;
            }

            // finally clean up the whole library here
        }
    }
}
```

2.7.2 Control by another Application or Library

To set up and run ECJ from an external application or library, you need to get a parameter database, initialize ECJ on it, and start it running. Most likely you'll be running ECJ multiple times, so it makes sense to construct a single `ParameterDatabase`, then clone it repeatedly for each time ECJ does an optimization run.

You could create your initial `ParameterDatabase` by pointing it at a file:

```
File parameterFile = ...
ParameterDatabase dbase = new ParameterDatabase(parameterFile,
        new String[] { "-file", parameterFile.getCanonicalPath() });
```

There are other options besides loading from files of course: see Section 2.1.8. Once you have created your `ParameterDatabase`, you'll likely want to make copies of it over and over again so you can customize some of its parameters differently each time you run ECJ from the application or library. You could do this in two ways. You could just make a `ParameterDatabase` which uses the original database as its parent:

```
ParameterDatabase child = new ParameterDatabase();
child.addParent(dbase);
```

I instead prefer to first copy the original so as to keep a completely separate version in case there are multithreading issues. Here we use `ec.util.DataPipe` to copy the `ParameterDatabase`, because it's not `Cloneable`:⁸

```
ParameterDatabase copy = (ParameterDatabase)(DataPipe.copy(dbase));
ParameterDatabase child = new ParameterDatabase();
child.addParent(dbase);
```

Once you have your `ParameterDatabase` ready, it's time to add some custom parameters. Perhaps each time you're setting up ECJ from your application you want it to run in a slightly different way. Notably you may want to customize the random number seed. You can do it like this:

```
child.set(...);
child.set(...);
child.set(...);
// ... etc...
```

(and so on). Now you set up the `Output` class. At this point you may wish to quiet `stdout` and `stderr` if you don't want ECJ polluting them:

```
Output out = Evolve.buildOutput();

// this stuff is optional
out.getLog(0).silent = true; // stdout
out.getLog(1).silent = true; // stderr
```

You can shut up the `Statistics` log with this parameter:

```
stat.file = /dev/null
```

Now you initialize ECJ and start it running:

```
EvolutionState evaluatedState = Evolve.initialize(child, 0, out);
evaluatedState.run(EvolutionState.C_STARTED_FRESH);
```

⁸This isn't ECJ's fault. It's because `ParameterDatabase` is a subclass of `java.util.Properties`, which is `Cloneable` only in the most recent versions of Java.

This runs the whole thing from start to end, then returns. Alternatively to pulse ECJ every generation (maybe so you can test stuff per-generation) you could say:

```
EvolutionState evaluatedState = Evolve.initialize(child, 0, out);
evaluatedState.startFresh();
int result = EvolutionState.R_NOTDONE;
while( result == EvolutionState.R_NOTDONE )
    result = evaluatedState.evolve();
```

At this point you might wish to check the Statistics to see what the results were. Let's say it's a SimpleStatistics. You could then say:

```
// inds is an array, one per subpopulation
Individual[] inds = ((SimpleStatistics)(evaluatedState.statistics)).getBestSoFar();
// ... grab the Fitness from these Individuals, etc. ...
```

Finally, you clean up.

```
Evolve.cleanup(evaluatedState);
```

And you can forget about evaluatedState at this point.

Chapter 3

ec.EvolutionState and the ECJ Evolutionary Process

As discussed in Section 2, the purpose of the `ec.Evolve` class is simply to set up an `ec.EvolutionState` and get it going. `ec.EvolutionState` is the central object in all of ECJ.

An ECJ process has only one `ec.EvolutionState` instance. Practically everything in ECJ, except for `ec.Evolve` itself, is pointed to somehow from `ec.EvolutionState`, so if you checkpoint `ec.EvolutionState`, the entire ECJ process is written to disk. Various subclasses of `ec.EvolutionState` define the stochastic optimization process. And a great many methods are handed the `ec.EvolutionState` instance, and so have essentially global access to the system.

If you peek inside `ec.EvolutionState`, you will find a number of objects, as shown in Figure 3.1:

- Some familiar objects, placed there by `ec.Evolve` after it created the `ec.EvolutionState`: the **Parameter Database**, **Output**, and array of **Random Number Generators**. Additionally, the number of **breeding threads** and **evaluation threads** (and various checkpoint and job stuff, not shown below):

```
public ec.util.ParameterDatabase parameters;  
public ec.util.MersenneTwisterFast[] random;  
public ec.util.Output output;  
public int breedthreads;  
public int evalthreads;
```

- A **Population**, which holds the individuals in the evolutionary process; plus the current **generation** (iteration) of the evolutionary process and the total **number of generations** to run, or alternatively the total **number of evaluations** to run. How or whether these last three variables are used depends on the evolutionary process in question.

```
public ec.Population population;  
public int generation;  
public int numGenerations = UNDEFINED;  
public int numEvaluations = UNDEFINED;
```

Some notes. The default setting for `numEvaluations` and `numGenerations` is `EvolutionState.UNDEFINED` (0). One of these two variables will be set at parameter-loading time. The other will stay, initially, at `UNDEFINED`. If `numEvaluations` was set, and generational evolution is being used, then `numGenerations` will eventually be set to a real value after the initial population has been created but before it has been evaluated. We'll get to how these are set later, in the Generational and Steady-State sections (Sections 4.1 and 4.2).

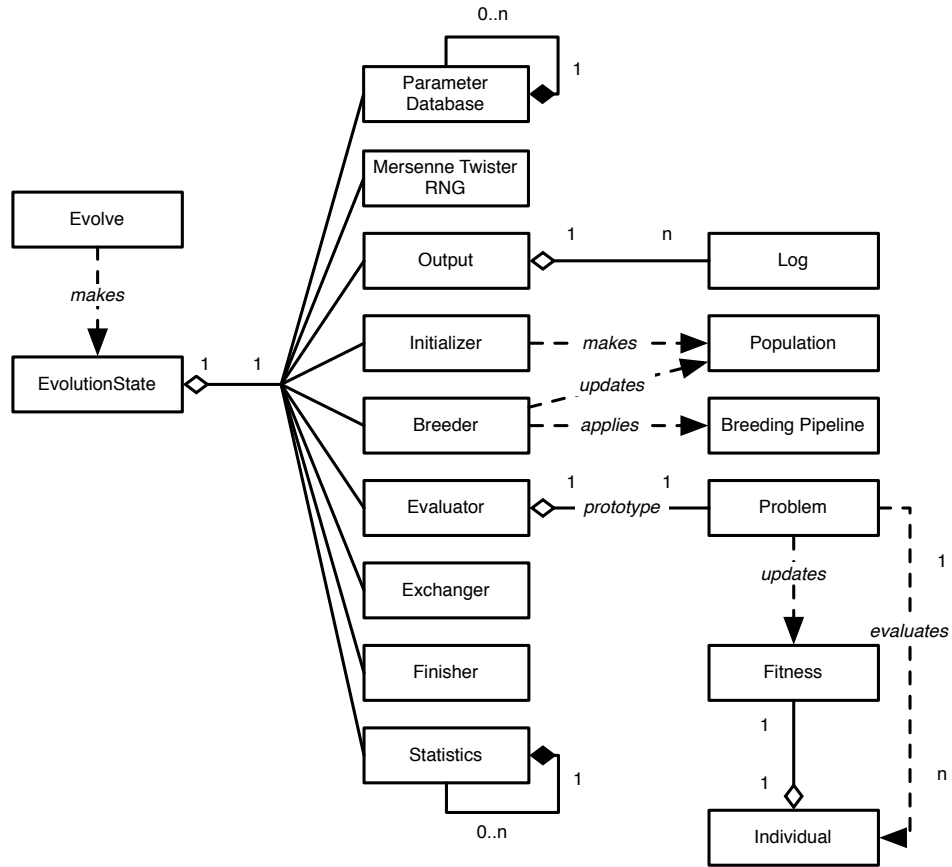

Figure 3.1 Top-Level operators and utility facilities in EvolutionState, and their relationship to certain state objects. A repeat of Figure 1.2. Compare to Figure 4.2.

- An **Initializer**, whose job is to create the initial ec.Population at the beginning of the run, and a **Finalizer**, whose job is to clean up at the very end of the run.

```
public ec.Initializer initializer;
public ec.Finalizer finalizer;
```

- An **Evaluator**, whose job is assign quality assessments (fitnesses) to each member of the Population, and a **Breeder**, whose job is to produce a new Population from the previous-generation's Population through some collection of selection and modification operators.

```
public ec.Evaluator evaluator;
public ec.Breeder breeder;
```

- An **Exchanger**, which optionally exports Population members to other ECJ processes, or imports ones to add to the Population. And finally, a **Statistics** object, whose methods are called at many points in the run to output statistics on the current run performance.

```
public ec.Exchanger exchanger;
public ec.Statistics statistics;
```

3.1 Common Patterns

Most of ECJ's classes follow certain patterns which you'll see many times, so it's useful to review them here.

3.1.1 Setup

Nearly all classes adhere to the `ec.Setup` interface. This interface is `java.io.Serializable` (which is why ECJ can serialize all its objects) and defines a single method:

ec.Setup Methods

```
public void setup(EvolutionState state, Parameter base)
```

Constructs the Setup object from the Parameter Database using *base* as the primary parameter base. Nearly all ECJ classes implement this method.

ECJ objects are born from ECJ's Parameter Database, which constructs them with the default (no-argument) constructor. Then they have `setup(...)` called on them, and are expected to construct themselves by loading parameters as necessary from the Parameter Database (`state.parameters`), using the provided Parameter base. **Thus the `setup(...)` method is, for all intents and purposes, the constructor for nearly all ECJ objects.**

When implementing `setup(...)` always call `super.setup(...)` if a superclass exists.

3.1.2 Singletons and Cliques

Singletons (`ec.Singleton`) are Setups which create a single instance per evolutionary run, and that's it. For example, `ec.EvolutionState` is a Singleton, as are `ec.Initializer`, `ec.Finalizer`, `ec.Evaluator`, `ec.Breeder`, `ec.Exchanger`, and `ec.Statistics`. Singletons are generally meant to be globally accessible.

Though Singletons are single objects, Cliques (`ec.Clique`) are objects for which only a small number (but usually more than 1) are created. Cliques are also generally meant to be globally accessible. Most Cliques have a globally accessible registry of some sort in which all Clique members can be found.

Because they are global, Prototypes and Singletons usually are set up from a single parameter base (the one provided by `setup(...)`).

3.1.3 Prototypes

Prototypes (`ec.Prototype`) are by far the most common objects in ECJ. Prototypes are Setups which follow the following design pattern: only one instance is loaded from the Parameter Database and set up; this object is the *prototype*. Then many objects are created by *deep cloning* the prototype. One example of a Prototype is an Individual (`ec.Individual`): a single prototypical Individual is created when ECJ starts up; and further Individuals are deep cloned from this prototype to fill Populations.

Because they can be deep cloned, Prototypes implement the `java.lang.Cloneable` interface, so you must implement the method:

ec.Prototype Methods

```
public Object clone()
```

Deep-clones the object. Implemented by all Prototypes. Must call `super.clone()`, possibly catching a thrown `CloneNotSupportedException`.

Unlike Singletons and Cliques, Prototypes also usually have *two* parameter bases: the primary base provided by `setup(...)`, and a default base. As a result, Prototypes must implement a method which can be called to provide this default base:

ec.Prototype Methods

```
public ec.util.Parameter defaultBase()
    Returns the default base for the Prototype.
```

The standard way to implement this method is to consult a special **defaults class** in the Parameter's Java package. For example, in the ec.simple package the defaults class is ec.simple.SimpleDefaults. Here's the entirety of this class:

```
public final class SimpleDefaults implements ec.DefaultsForm
{
    public static final String P_SIMPLE = "simple";
    public static final Parameter base() { return new Parameter(P_SIMPLE); }
}
```

The Parameter returned by base() here provides **package default base** for the ec.simple package. Now consider ec.simple.SimpleFitness, a Prototype in this package. This class implements the defaultBase() method like this:

```
public static final String P_FITNESS = "fitness";
public Parameter defaultBase()
{
    return SimpleDefaults.base().push(P_FITNESS);
}
```

Thus, as a result the default parameter base for ec.simple.SimpleFitness is simple.fitness.

3.1.4 The Flyweight Pattern

Many Prototypes follow what is commonly known as the **flyweight pattern**. Prototypes are often great in number and Java is a memory hog: so it's helpful for groups of Prototypes to place shared information common to them in a single central location rather than keep copies of their own. For various reasons (particularly because it's hard to do serialization) ECJ doesn't use static variables to store this common information. Instead groups of Prototypes often all point to a special object which contains information common to all of them. For example, instances of ec.Individual, in groups, typically share a common ec.Species which contains information common to them. At any particular time there may be several such groups of Individuals, each with a *different* Species.

3.1.5 Groups

Groups are similar to Prototypes in that a single object is loaded from the Parameter Database and further objects are created by a cloning procedure. Groups are likewise java.lang.Cloneable. However, Groups are different in that there is no prototype per se: the object loaded from the Parameter Database isn't held in reserve but is actively used. It must not just clone another object, but actually create a new, fresh, clean object ready to be used. This is done by implementing the method:

ec.Group Methods

```
public ec.util.Parameter emptyClone()
    Returns a pristine, new clone of the Group which has been emptied of members.
```

This method is normally implemented by cloning the object, cleaning out the clone, and returning it in the same pristine state that it would be if it had been created directly from the Parameter Database. At

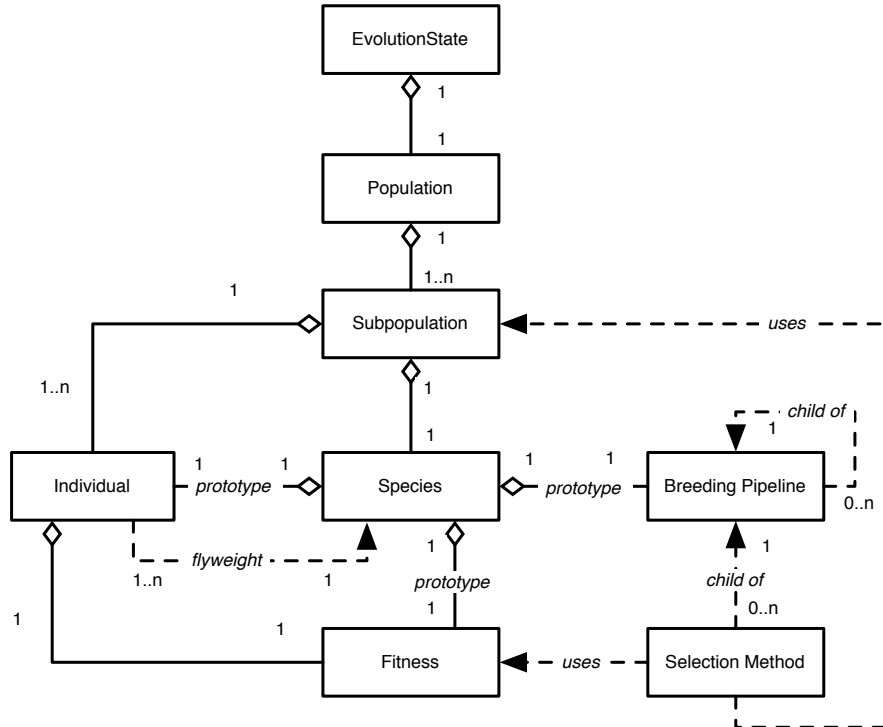

Figure 3.2 Top-Level data objects used in evolution. A repeat of Figure 1.3.

present there are only a few ECJ objects which implement Group: namely, *ec.Population*, *ec.Subpopulation*, and certain specialized subclasses of *ec.Subpopulation*.

3.2 Populations, Subpopulations, Species, Individuals, and Fitnesses

Populations, Subpopulations, and Individuals are the “nouns” of an evolutionary system, and Fitnesses are the “adjectives”. They’re pretty central to the operation of any evolutionary or sample-based stochastic search algorithm.

In ECJ, an **individual** is a candidate solution to a problem. Some M Individuals are grouped together into a sample of solutions known as a **subpopulation**. Some N subpopulations are grouped together into the system’s **population**. There’s only one population per evolutionary process. The most common scenario is for ECJ to have M individuals grouped into a single subpopulation, which then is the sole member of ECJ’s population. However, coevolutionary algorithms (Section 7.1) typically have $N > 1$ subpopulations: as does a special and little-used internal island model scheme (see Section 6.2).¹

Usually ECJ’s population is an instance of the class *ec.Population* and its subpopulations are instances of the class *ec.Subpopulation*. Both of these are Groups. Let’s say that there’s a single subpopulation, which must contain 100 individuals. We can express this as follows:

```
pop = ec.Population
pop.subpops = 1
pop.subpop.0 = ec.Subpopulation
pop.subpop.0.size = 100
```

¹Because these two techniques use the subpopulations in different ways, they cannot be used together (a rare situation in ECJ).

Obviously further subpopulations would be `pop.subpop.1`, `pop.subpop.2`, etc. The population is found in an instance variable in the `EvolutionState`:

```
public Population population;
```

The `Population` is little more than an array of `Subpopulations`. To get `Subpopulation 0`, with the `EvolutionState` being `state`, you'd say:

```
Subpopulation theSubpop = state.population.subpops.get(0);
```

`Subpopulations` themselves contain arrays of `Individuals`. To get `Individual 15` of `Subpopulation 0`, you'd say:

```
Individual theIndividual = state.population.subpops.get(0).individuals.get(15);
```

In addition to an array of `Individuals`, each `subpopulation` contains a **species** which defines the `Individuals` used to fill the `subpopulation`, as well as their fitness and the means by which they are modified. `Subpopulations` also contain some basic parameters for creating initial `Individuals`, though the procedure is largely handled by `Species`.² We'll get to creation and modification later.

`Species` have an odd relationship to `Individuals` and to `Subpopulations`. First recall the `Flyweight` pattern in Section 3.1.4. `Individuals` are related to a common `Species` using the `Flyweight` pattern: they use `Species` to store a lot of common information (how to modify themselves, for example). Ordinarily you'd think that the `Subpopulation` would be a good place for this storage. However different `Subpopulations` can share the same `Species`. This allows you to, for example, have one `Species` guide an entire evolutionary run that might have twenty `Subpopulations` in it.³ The `species` of `Subpopulation 0` may be found here:

```
Species theSpecies = state.population.subpops.get(0).species;
```

A `Species` contains three major elements: first, the **prototypical Individual** for `Subpopulations` which use that `Species`. Recall that `Individuals` are `Prototypes` and new ones are formed by cloning from a `prototypical individual` held in reserve. This "queen bee" `individual`, so to speak, is found here:

```
Individual theProto = state.population.subpops.get(0).species.i_prototype;
```

A `Species` also contains a **prototypical Fitness** object. In ECJ *fitnesses* are separate from *Individuals*. `Individuals` define the candidate solution, and `Fitnesses` define how well it has performed. Like `Individuals`, `Fitnesses` are also `Prototypes`. The `prototypical Fitness` for `Subpopulation 0` may be found here:

```
Fitness theProtoFitness = state.population.subpops.get(0).species.f_prototype;
```

The `Species` class you pick is usually determined by the kind of `Individual` you pick, that is, by the kind of representation of your solution. You define the class of the `Species` for `Subpopulation 0`, and its `prototypical Fitness` and `prototypical Individual`, as follows. For example, let's make `Individuals` which are arrays of integers, and a simple `Fitness` common to many evolutionary algorithms:

```
pop.subpop.0.species = ec.vector.IntegerVectorSpecies  
pop.subpop.0.species.ind = ec.vector.IntegerVectorIndividual  
pop.subpop.0.species.fitness = ec.simple.SimpleFitness
```

By way of explanation, `IntegerVectorIndividual`, along with various other "integer" vector `Individuals` like `LongVectorIndividual`, `ShortVectorIndividual`, and `ByteVectorIndividual`, requires an `IntegerVectorSpecies`. And `ec.simple.SimpleFitness` is widely used for problems such as `Genetic Algorithms` or `Evolution Strategies`. The

²You might be asking: if `Species` are responsible for making `Individuals`, why are `Subpopulations` involved at all? A very good question indeed.

³Granted, this isn't very common.

prototypical Individual is never assigned a Fitness (it's null). But once assembled in a Subpopulation, each Individual has its very own Fitness. To get the Fitness of individual 15 in Subpopulation 0, you'd say:

```
Fitness theFitness = state.population.subpops.get(0).individuals.get(15).fitness;
```

Last, a Species contains a **prototypical Breeding Pipeline** to modify individuals. We'll get to that in Section 3.5.

Since they're Prototypes, Individuals, Fitnesses, and Species all have default bases. We'll talk about the different kinds of Individuals, Fitnesses, and Species later, plus various default bases for them.

3.2.1 Making Large Numbers of Subpopulations

Let's say you're doing an evolutionary experiment (perhaps coevolution, see Section 7.1) which involves 100 Subpopulations. It's going to get very tiresome to repeat...

```
pop = ec.Population
pop.subpops = 100
pop.subpop.0 = ec.Subpopulation
pop.subpop.0.size = 100
pop.subpop.0.species = ec.vector.IntegerVectorSpecies
pop.subpop.0.species.ind = ec.vector.IntegerVectorIndividual
pop.subpop.0.species.fitness = ec.simple.SimpleFitness
....
pop.subpop.1 = ec.Subpopulation
pop.subpop.1.size = 100
pop.subpop.1.species = ec.vector.IntegerVectorSpecies
pop.subpop.1.species.ind = ec.vector.IntegerVectorIndividual
pop.subpop.1.species.fitness = ec.simple.SimpleFitness
....
pop.subpop.2 = ec.Subpopulation
pop.subpop.2.size = 100
pop.subpop.2.species = ec.vector.IntegerVectorSpecies
pop.subpop.2.species.ind = ec.vector.IntegerVectorIndividual
pop.subpop.2.species.fitness = ec.simple.SimpleFitness
....
```

... and so on some 100 times. Even with the help of ECJ's default parameters, you'll still be typing an awful lot. Population has a simple mechanism to make this easier on you: the parameter...

```
pop.default-subpop = 0
```

This says that if you *do not* specify a Subpopulation in parameters, ECJ will assume its parameters are identical for those of Subpopulation 0. Thus you could simply say:

```
pop = ec.Population
pop.subpops = 100
pop.default-subpop = 0
pop.subpop.0 = ec.Subpopulation
pop.subpop.0.size = 100
pop.subpop.0.species = ec.vector.IntegerVectorSpecies
pop.subpop.0.species.ind = ec.vector.IntegerVectorIndividual
pop.subpop.0.species.fitness = ec.simple.SimpleFitness
...
```

... and be done with it. Note that you can always specify a Subpopulation specially. For example, suppose all of your Subpopulations were exactly like Subpopulation 0 *except* for Subpopulation 19. You can say:

```
pop = ec.Population
pop.subpops = 100
pop.default-subpop = 0
pop.subpop.0 = ec.Subpopulation
pop.subpop.0.size = 100
pop.subpop.0.species = ec.vector.IntegerVectorSpecies
pop.subpop.0.species.ind = ec.vector.IntegerVectorIndividual
pop.subpop.0.species.fitness = ec.simple.SimpleFitness
...
pop.subpop.19 = ec.Subpopulation
pop.subpop.19.size = 25
pop.subpop.19.species = ec.vector.FloatVectorSpecies
pop.subpop.19.species.ind = ec.vector.DoubleVectorIndividual
pop.subpop.19.species.fitness = ec.simple.SimpleFitness
...
```

Note that even though Subpopulation 19 shared the same fitness type as the others, we still had to specify it. It's an all-or-nothing proposition: either you say *nothing* about that particular Subpopulation, or you say *everything*.

3.2.2 How Species Make Individuals

Species have two ways to create new individuals: from scratch, or reading from a stream. To generate an individual from scratch, you can call (in `ec.Species`):

ec.Species Methods

```
public Individual newIndividual(EvolutionState state, int thread)
    Returns a brand new, randomized Individual.
```

The default implementation of this method simply clones an Individual from the prototype and returns it. Subclasses of Species override this to randomize the Individual in a fashion appropriate to its representation.

Another way to create an individual is to read it from a binary or text stream. `ec.Species` provides two methods for this:

ec.Species Methods

```
public Individual newIndividual(EvolutionState state, LineNumberReader reader) throws IOException
    Produces a new individual read from the stream.
```

```
public Individual newIndividual(EvolutionState state, DataInput input) throws IOException
    Produces a new individual read from the given DataInput.
```

These methods create Individuals by cloning the prototype, then calling the equivalent `readIndividual(...)` method in `ec.Individual`. See Section 3.2.4 for more information on those methods.

3.2.3 Reading and Writing Populations and Subpopulations

Populations and Subpopulations have certain predefined methods for reading and writing, which you should know how to use. If you subclass Population or Subpopulation (relatively rare) you may need to reimplement these methods. Population's methods are:

```

public void printPopulationForHumans(EvolutionState state, int log);
public void printPopulation(EvolutionState state, int log);
public void printPopulation(EvolutionState state, PrintWriter writer);
public void readPopulation(EvolutionState state, LineNumberReader reader)
                                                    throws IOException;
public void writePopulation(EvolutionState state, DataOutput output)
                                                    throws IOException;
public void readPopulation(EvolutionState state, DataInput input)
                                                    throws IOException;

```

Subpopulation's methods are nearly identical:

In Subpopulation:

```

public void printSubpopulationForHumans(EvolutionState state, int log);
public void printSubpopulation(EvolutionState state, int log);
public void printSubpopulation(EvolutionState state, PrintWriter writer);
public void readSubpopulation(EvolutionState state, LineNumberReader reader)
                                                    throws IOException;
public void writeSubpopulation(EvolutionState state, DataOutput output)
                                                    throws IOException;
public void readSubpopulation(EvolutionState state, DataInput input)
                                                    throws IOException;

```

These methods employ similar methods in `ec.Individual` to print out, or read, Individuals. Those methods are discussed next in Section 3.2.4.

The first Population method, `printPopulationForHumans(...)`, prints an entire population to a log in a form pleasing to the human eye. It begins by printing out the number of subpopulations, then prints each Subpopulation index and calls `printSubpopulationForHumans(...)` on each Subpopulation in turn. `printPopulationForHumans(...)` then prints out the number of individuals, then for each Individual it prints the Individual index, then calls `printIndividualForHumans` to print the Individual. Overall, it looks along these lines:

```

Number of Subpopulations: 1
Subpopulation Number: 0
Number of Individuals: 1000
Individual Number: 0
Evaluated: T
Fitness: 0.234
-4.97551104730313 -1.7220830524609632 1.7908415218297096
2.3277606156190496 3.5616099573877404 -3.8002895023118617
Individual Number: 1
Evaluated: T
Fitness: 4.91235
3.1033182498148575 -3.613847679151146 -0.562978505270439
-2.860926011046968 1.9007479097991151 -3.051348823625001
...

```

The next two Population methods, both named `printPopulation(...)`, print an entire population to a log in a form that can be (barely) read by humans but can also be read back in perfectly by ECJ, resulting in identical Populations These operate similarly to `printPopulationForHumans(...)`, except that various data types are emitted using `ec.util.Code` (Section 2.2.3).

```

Number of Subpopulations: i1|
Subpopulation Number: i0|
Number of Individuals: i1000|
Individual Number: i0|
Evaluated: F
Fitness: f0|0.0|
i6|d4600627607395240880|0.3861348728170766|d4616510324226321041|4.284844300646584|
d4614576621171274054|3.2836854885228233|d4616394543356495435|4.182010230653371|
Individual Number: i1|
Evaluated: F
Fitness: f0|0.0|
i6|d4603775819114015296|0.6217914592919627|d4612464338011645914|2.345643329183969|
d-4606767824441912859|-4.368233761797886|d4616007477858046134|3.919113503960115|
...

```

The Population method `readPopulation(..., LineNumberReader)` can read in this mess to produce a Population. It in turn does its magic by calling the equivalent method in Subpopulation.

The last two methods, `writePopulation(...)` and `readPopulation(..., DataInput)`, read and write Populations (or Subpopulations) to binary files.

3.2.4 About Individuals

Individuals have four basic parts:

- The Individual's fitness.

```
public Fitness fitness;
```

- The Individual's species.

```
public Species species;
```

- Whether the individual has been evaluated and had its Fitness set to a legal value yet.⁴

```
public boolean evaluated;
```

- The representation of the Individual. This could be anything from an array to a tree structure—representations of course vary and are defined by subclasses. We'll talk about them later.

3.2.4.1 Implementing an Individual

For many purposes you can just use one of the standard “off-the-rack” individuals — vector individuals, genetic programming tree individuals, ruleset individuals — but if you need to implement one yourself, here are some methods you need to be aware of. First off, Individuals are Prototypes and must override the `clone()` method to deep-clone themselves, including deep-cloning their representation and their Fitness, but not their Species (which is just pointer-copied). Individuals must also implement the `setup(...)`, and `defaultBase()` methods. Additionally, Individuals have a number of methods which either should or must be overridden. Let's start with the “must override” ones:

```
public abstract int hashCode();
public abstract boolean equals(Object individual);
```

⁴Why isn't this in the Fitness object? Another excellent question.

These two standard Java methods enable hashing by value, which allows Subpopulations to remove duplicate Individuals. `hashCode()` must return a hashcode for an individual based on value of its representation. `equals(...)` must return true if the Individual is identical to the other object (which in ECJ will always be another Individual).

The next two methods are optional and may not be appropriate depending on your representation:

```
public long size();
public double distanceTo(Individual other);
```

`size()` returns an estimate of the size of the individual. The only hard-and-fast rule is that 0 is the smallest possible size (and the default returned by the method). Size information is largely used by the `ec.parsimony` package (Section 5.2.12) to apply one of several parsimony pressure techniques.

`distanceTo(...)` returns an estimate of the distance, in some metric space, of the Individual to some other Individual of the same type. In the future this method may be used for various crowding or niching methods. At present no package uses it, though all vector individuals implement it. The default implementation returns 0 if the other Individual is identical, else `Double.POSITIVE_INFINITY`.

Last come a host of functions whose purpose is to read and write individuals. You've seen this pattern before in Section 3.2.3. Some of these are important to implement; others can wait if you're in a hurry to get your custom Individual up and running.

```
public void printIndividualForHumans(EvolutionState state, int log);
public void printIndividual(EvolutionState state, int log);
public void printIndividual(EvolutionState state, PrintWriter writer);
public void readIndividual(EvolutionState state, LineNumberReader reader)
                                                                    throws IOException;
public void writeIndividual(EvolutionState state, DataOutput output)
                                                                    throws IOException;
public void readIndividual(EvolutionState state, DataInput input)
                                                                    throws IOException;
```

These six methods only need to be overridden in certain situations, and in each case there's another method which is typically overridden instead. Here's what they do:

- `printIndividualForHumans(...)` prints an individual, whether it's been evaluated, and its fitness, out a log in a way that's pleasing and useful for real people to read. Rather than override this method, you probably should instead override this method:

```
public String genotypeToStringForHumans();
```

... which should return the representation of the individual in a human-pleasing fashion. Or, since `genotypeToStringForHumans()` by default just calls `toString()`, you can just override:

```
public String toString();
```

Overriding one or both of these methods is pretty important: otherwise Statistics objects will largely be printing your individuals as gibberish. Here's a typical output of these methods:

```
Evaluated: T
Fitness: 0.234
-4.97551104730313 -1.7220830524609632 1.7908415218297096
2.3277606156190496 3.5616099573877404 -3.8002895023118617
```

- Both `printIndividual(...)` methods print an individual, and its fitness, out in a way that can be perfectly

read back in again with `readIndividual(...)`, but which can also be parsed by humans with some effort. Rather than override this method, you probably should instead override this method:

```
public String genotypeToString();
```

This method is important to implement only if you intend to write individuals out to files in such a way that you can load them back in later. If you don't implement it, `toString()` will be used, which probably won't be as helpful. This returns a `String` which can be parsed in again in the next method. Note that you need to write an individual out so that it can *perfectly* be read back in again as an identical individual. How do you do this? ECJ's classes by default all use the aging and idiosyncratic package `ec.util.Code` package developed long ago for this purpose, but which still works well. See Section 2.2.3. Here's a typical output of these methods (note the use of `ec.util.Code`):

```
Evaluated: F
Fitness: f0|0.0|
i6|d4600627607395240880|0.3861348728170766|d4616510324226321041|4.284844300646584|
d4614576621171274054|3.2836854885228233|d4616394543356495435|4.182010230653371|
```

- `readIndividual(..., LineNumberReader)` reads an individual, and its fitness, in from a `LineNumberReader`. The stream of text being read is assumed to have been generated by `printIndividual(...)`. Rather than override this method, you probably should instead override this method:

```
protected void parseGenotype(EvolutionState state, LineNumberReader reader)
    throws IOException;
```

This modifies the existing `Individual`'s genotype to match the genotype read in from the reader. The genotype will have been written out using `printIndividual(...)`. You only need to override this method if you plan on reading individuals in from files (by default the method just throws an error).

- The last two methods (`writeIndividual(...)` and `readIndividual(..., DataInput)`) read and write an individual, including its representation, fitness and evaluated flag, in a purely binary fashion to a stream. Don't write the `Species`. It's probably best instead to override the following methods to just read and write the genotype:

```
public void writeGenotype(EvolutionState state, DataOutput output)
    throws IOException;
public void readGenotype(EvolutionState state, DataInput input)
    throws IOException;
```

These methods are probably only important to implement if you plan on using ECJ's distributed facilities (distributed evaluator, island models). The default implementations of these methods simply throw exceptions.

3.2.5 About Fitnesses

Fitnesses are separate from `Individuals`, and various `Fitnesses` can be used depending on the demands of the evolutionary algorithm. The most common `Fitness` is `ec.simple.SimpleFitness`, which represents fitness as a single number from negative infinity to positive infinity, where larger values are "fitter". Certain selection methods (notably fitness proportionate selection) require that the fitness be non-negative; and ideally between 0 and 1 inclusive.

There are other Fitness objects. For example, there are various multiobjective fitnesses (see Section 7.5), in which the fitness value is not one but some N numbers, and either higher or lower may be better depending on the algorithm. Other Fitnesses, like the one used in genetic programming (Section 5.2), maintain a primary Fitness statistic and certain auxiliary ones.

You probably won't need to implement a Fitness object. But you may need to use some of the methods below. Fitnesses are Prototypes and so must implement the `clone()` (as a deep-clone), `setup(...)`, and `defaultBase()` methods. Fitness has four additional required methods:

```
public abstract double fitness();
public abstract boolean isIdealFitness();
public abstract boolean equivalentTo(Fitness other);
public abstract boolean betterThan(Fitness other);
```

The first method, `fitness()`, should return the fitness cast into a value from negative infinity to positive infinity, where higher values are better. This is used largely for fitness-proportionate and similar selection methods. If there is no appropriate mechanism for this, you'll need to fake it. For example, multiobjective fitnesses might return the maximum or sum over their various objectives.

The second method, `isIdealFitness()`, returns true if the fitness in question is the best possible. This is largely used to determine if it's okay to quit. It's fine for this method to always return false if you so desire.

The third and fourth methods compare against another fitness object, of the same type. The first returns true if the two Fitnesses are in the same equivalence class: that is, neither is fitter than the other. For simple fitnesses, this is just equality. For multiobjective fitnesses this is Pareto-nondomination of one another. The second method returns true if the Fitness is superior to the one provided in the method. For simple fitnesses, this just means fitter. For multiobjective fitnesses this implies Pareto domination.

Fitnesses also have similar printing facilities to Individuals:⁵

```
public void printFitnessForHumans(EvolutionState state, int log);
public void printFitness(EvolutionState state, int log);
public void printFitness(EvolutionState state, PrintWriter writer);
public void readFitness(EvolutionState state, LineNumberReader reader)
                                                                    throws IOException;
public void writeFitness(EvolutionState state, DataOutput output)
                                                                    throws IOException;
public void readFitness(EvolutionState state, DataInput input)
                                                                    throws IOException;
```

As usual: the first method, `printFitnessForHumans(...)`, prints a Fitness in a way pleasing for humans to read. It simply prints out the result of the following method (which you should override instead if you ever need to):

```
public String fitnessToStringForHumans();
```

The default implementation of `fitnessToString()` simply calls:

```
public String toString();
```

The next two methods, both named `printFitness(...)`, prints a Fitness in a way that can be (barely) read by humans, and can be read by ECJ to produce an identical Fitness to the original. These methods just print out the result of the following method (which you should override instead if you ever need to):

```
public String fitnessToString();
```

⁵Starting to get redundant? Sorry about that.

The default implementation of this method calls `toString()`, which is almost certainly wrong. But all the standard `Fitness` subclasses implement it appropriately using the `ec.util.Code` tools (Section 2.2.3).

The method `readFitness(..., LineNumberReader)` reads into ECJ a `Fitness` written by these last two printers. Finally, the last two methods, `writeFitness(...)` and `readFitness(..., DataInput)`, read and write the `Fitness` in a binary fashion. The default implementation of these methods throws an error, but all standard subclasses of `Fitness` implement them properly.

`Fitnesses` have two auxiliary variables:

```
public ArrayList trials = null;
public Individual[] context = null;
```

These variables are used by coevolutionary processes (see Section 7.1) to keep track of the number of trials (in the form of `java.lang.Double` used to compute the `Fitness` value, and to maintain the context (other collaborating `Individuals`) which produced the best result represented by the `Fitness`. Outside of coevolution they're presently unused: leave them null and they won't be printed.

`Fitnesses` have three hooks which can be used to merge multiple `Fitness` values into one, if appropriate (for example, this doesn't make much sense for multiobjective `fitnesses`). Though this could be used to assemble a `Fitness` over multiple trials, `Coevolution` uses the different mechanism above to achieve this which preserves contextual information (see Section 7.1). One method `setToMeanOf(...)`, is unimplemented in the `Fitness` class proper, though it's been implemented in common subclasses in ECJ. If you make your own `Fitness` object you might ultimately want to implement this method if appropriate, but it's not necessary in most cases. The other two methods call `setToMeanOf(...)` internally.

ec.util.Fitness Methods

```
public void setToMeanOf(EvolutionState state, Fitness[] fitnesses)
```

Sets the fitness to the mean of the provided fitness values. By default this method is unimplemented and generates an error. Common subclasses (like `SimpleFitness` and `KozaFitness`) override this method and implement it. Other classes, such as `MultiobjectiveFitness` and its subclasses,, do not, since there is no notion of a "mean" in that context. You do not have to implement this utility method in most situations.

```
public void setToMedianOf(EvolutionState state, Fitness[] fitnesses)
```

Sets the fitness to the median of the provided fitness values. This method calls `setToMeanOf(...)` in its implementation.

```
public void setToBestOf(EvolutionState state, Fitness[] fitnesses)
```

Sets the fitness to the best of the provided fitness values. This method calls `setToMeanOf(...)` in its implementation.

3.3 Initializers and Finishers

The **Initializer** is called at the beginning of an evolutionary run to create the initial population. The **Finisher** is called at the end of a run to clean up. In fact, it's very rare to use any `Finisher` other than `ec.simple.Finisher`, which does nothing at all. So nearly always you'll have this:

```
finish = ec.simple.SimpleFinisher
```

Initializers vary largely based on representation, but not for the reason you think. Initializers generally don't need to know anything about the representation of an individual in order to construct it. Instead, certain representations require a lot of pieces which need to be in a central repository (they're `Cliques`). For example, the genetic programming facility (Section 5.2) has various *types*, *function sets*, *tree constraints*, *node constraints*, etc. It's not in ECJ's style to store these things as static variables because of the difficulty it presents for serialization. Instead ECJ needed a global object to hold them, and Initializers were chosen for that task.

It's probably not been the smartest of decisions: Finishers (which have historically had little purpose) could have been recruited to the job, or some generic type repository perhaps. As it stands, Initializers aren't an optimal location, but there it is.⁶

Unless you're doing genetic programming (`ec.gp`) or using the `ec.rule` package, you'll probably use a `ec.simple.SimpleInitializer`:

```
init = ec.simple.SimpleInitializer
```

ECJ's generational⁷ initialization procedure goes like this:

1. The `EvolutionState` asks the `Initializer` to build a `Population` by calling:

```
population = state.initializer.initialPopulation(state, 0);
```

The 0 is thread index 0: this portion of the code is single-threaded.

2. The `Initializer` then creates and sets up a `Population` by calling the following on itself. It then tells the `Population` to populate itself with individuals:

```
Population pop = setupPopulation(state, 0);  
pop.populate(state, 0);
```

Why break this out? Because there are a few `EvolutionState` subclasses which don't want to populate the population immediately or at all — they just want to set it up. For example, steady state evolution sets up a `Population` but may only gradually fill it with initial population members. In this case, the steady state system will just call `setupPopulation(...)` directly, bypassing `initialPopulation(...)`.

3. The `Population`'s default `populate(...)` method is usually straightforward: it calls `populate(...)` in turn on each `Subpopulation` in the `Population`'s `subpopulation` array.

Alternatively, the `Population` can read an entire population from a file. This is determined by (as usual) a parameter! If the `Population` should be read in from the file `/tmp/population.in`, the parameter setting would be:

```
pop.file = /tmp/population.in
```

The `Population` will read `Subpopulations`, and ultimately `Individuals`, from this file by calling its `readPopulation(..., LineNumberReader)` method.

4. If the `Population` is not reading from a file, it will call `populate(...)` on each of its `Subpopulations`. A `Subpopulation`'s `populate(...)` method usually works like this. First, it determines if it should create new individuals from scratch or if it should fill its array by reading `Individuals` from a file. If the individuals are to be generated from scratch (the most common case by far), `Subpopulation` generates new individuals using the standard `newIndividual(...)` method in `ec.Species` (see Section 3.2.2). ECJ can also check to make sure that the `Subpopulation` does not produce duplicate individuals while generating from scratch, if you set the following parameter (in this case, in `Subpopulation 0`):

```
pop.subpop.0.duplicate-retries = 100
```

The default value is no retries. This says that if the `Subpopulation` creates a duplicate individual, it will try up to 100 times to replace it with a new, original individual. After that it will give up and use the duplicate individual.

⁶This makes it problematic to have both a "rule" representation and a genetic programming representation in the same run without a little hacking, since both require their own `Initializer`. Perhaps this might be remedied in the future.

⁷ECJ's Steady State evolution mechanism has a different initialization procedure. See Section 4.2 for more information.

You can also read Subpopulations directly from files, in a procedure similar to how it's done for Population. If Subpopulation 0 should be read in from the file `/tmp/subpopulation.in`, the parameter setting would be:

```
pop.subpop.0.file = /tmp/subpopulation.in
```

Subpopulations will try to read individuals from files using `readSubpopulation(..., LineNumberReader)`. If the number of individuals in the file is greater than the size of the Subpopulation, then the Subpopulation will be resized to match the file. If the number of individuals in the file is *less* than the size of the Subpopulation, then the Subpopulation will try to do one of three things:

- Truncate the Subpopulation to the size of the file. This is the default when reading from a file, but if you want to be explicit, it's specified like so:

```
pop.subpop.0.extra-behavior = truncate
```

- Wrap copies of the file's individuals repeatedly into the Subpopulation. For example, if the file had individuals A, B, and C, and the Subpopulation was of size 8, then it'd be filled with A, B, C, A B, C, A, B. This is particularly useful if you want to fill a file with copies of a single individual. This is specified like so:

```
pop.subpop.0.extra-behavior = wrap
```

- Fill the remainder of the Subpopulation with random individuals (see below). This is specified like so:

```
pop.subpop.0.extra-behavior = fill
```

These options aren't available if you're reading the whole Population from a file: it always truncates its Subpopulations appropriately. Note that if you're reading the Population from a file, you can't simultaneously read one of its Subpopulations from a file — that wouldn't make any sense.

3.3.1 Population Files and Subpopulation Files

If you write out a population using `printPopulation(...)`, the resulting file or print-out typically starts with a declaration of the number of subpopulations, followed by a declaration of a subpopulation number, then the number of individuals in that subpopulation, then the individuals one by one. After this come the declaration of the next subpopulation number, and the number of individuals in *that* subpopulation, then those individuals. And so on. It looks like this:

```
Number of Subpopulations: i3|
Subpopulation Number: i0|
Number of Individuals: i1024|
... [the individuals] ...
Subpopulation Number: i1|
Number of Individuals: i512|
... [the individuals] ...
Subpopulation Number: i2|
Number of Individuals: i2048|
... [the individuals] ...
```

But ECJ doesn't read in entire populations on initialization. Instead if you want to initialize your population from a file, you do so on a *per-subpopulation* basis, as in the parameters:

```
pop.subpop.0.file = myfile.in
```

A subpopulation file like this usually just has the the number of individuals for the subpopulation, followed by the individuals:

```
Number of Individuals: i512|
... [the individuals] ...
```

You can typically edit a subpopulation file out of a population file with some judicious typing: the relevant text is between the relevant “subpopulation Number:” lines.

In the example above, there are three subpopulations, because of the line

```
Number of Subpopulations: i3|
```

This “i3|” oddity is due to use of ECJ’s Code package (Section 2.2.3). The “i” means “integer”, the “3” is the value, and the “|” is a separator. Likewise subpopulation 0 starts with “i0|”.

3.4 Evaluators and Problems

ECJ evaluates (assesses the fitness of) Individuals in a Population by passing it to an `ec.Evaluator`. Various evolutionary algorithms and other stochastic search algorithms have their own special kinds of Evaluators. Evaluators perform this fitness assessment by cloning one or more **Problems**, discussed in the next Section, and asking these Problems to evaluate the individuals on their behalf. Evaluators hold the prototypical Problem here:

```
public Problem p_problem;
```

This problem is loaded from parameters. For example, to specify that we will use the Artificial Ant Problem to test our genetic programming Individuals, we’d say:

```
eval.problem = ec.app.ant.Ant
```

The basic Evaluator is `ec.simple.SimpleEvaluator`. This class evaluates a Population first by determining how many threads to use. To use four threads (for example), we say:

```
evalthreads = 4
```

The default value is a single thread.

Recall from Section 2.4 that this will require at least four random number generator seeds, for example:

```
seed.0 = 1234
seed.1 = -503812
seed.2 = 992341
seed.3 = -16723
```

When evaluating a Population, `ec.simple.SimpleEvaluator` will construct N Problems cloned from the Problem prototype, and assign one to each thread. Then, for each Subpopulation, the Evaluator will use these threads to evaluate the individuals in the Subpopulation. By default `SimpleEvaluator` simply breaks each Subpopulation into N even chunks and assigns each chunk to a different thread and its Problem. This enables the Population to be evaluated in parallel.

The problem with this approach to parallelism is that it’s not fine-grained: and so if some individuals take much longer to evaluate, then some threads will sit around waiting for a thread to finish its chunk. You can fix this by specifying the chunk size, all the way down to chunks of a single individual each. When an individual has finished its chunk, it will request another chunk to work on, and if it has exhausted on all the chunks in a Subpopulation, it’ll grab chunks from the next Subpopulation. For example, the extreme of fine-grained parallelism would be:

```
eval.chunk-size=1
```

The disadvantage of a small chunk size is that it involves a lot of locking to get each chunk. This is a small but significant overhead: so we suggest using the default (large automatic chunks) unless your evaluations are costly and of high variance in evaluation time.

Another disadvantage of a nonstandard chunk size is that threads run at different speeds and are no longer asynchronous: as a result, different runs with the same seeds could produce different results if evaluation is stochastic.

Of course, you probably most often don't do parallelism at all: you'll just have a single thread (that is, $N = 1$). In this case you have one further option: to avoid cloning the Problem each time, by setting the following parameter to false:

```
eval.clone-problem = false
```

If false, then the same Problem instance (the Prototype, in fact) will be used again and again. Obviously, this only is allowed if there's a single evaluation thread. And steady-state evolution (via `ec.simple.SteadyStateEvaluator`) does not support it.

The idea of not cloning the population and pipeline is due to Brian Olsen, a GMU PhD Student. Certain Evaluator methods are required. The primary method an Evaluator must implement is

```
public abstract void evaluatePopulation(EvolutionState state);
```

This method must take the Population (that is, `state.population`) and evaluate all the individuals in it in the fashion expected by the stochastic search algorithm being employed. Additionally, an Evaluator must implement the method

```
public abstract String runComplete(EvolutionState state);
```

... which returns a non-null String if the Evaluator believes the process has reached a terminating state. Typically this is done by scanning through the Population and determining if any of the Individuals have ideal fitnesses. The String provides a message for the user as to why the run terminated early (typically because the ideal individual was discovered). If you don't want to be bothered, it's fine to have this method always return null.

If you would like to terminate the run early for some other reason—perhaps you have run out of resources or got stuck somehow—you can call the following method to request that ECJ terminate its run at its earliest convenience. You provide a String which tells the user why you've decided to quit.

```
public void setRunComplete(String message);
```

3.4.1 Problems

Evaluators assess the fitness of individuals typically by creating one or more Problems and handing them chunks of Subpopulations to evaluate. There are two ways that an Evaluator can ask a Problem to perform evaluation:

- For each Individual, the Evaluator can call the Problem's *evaluation* method. This method varies depending on the kind of Problem. Problems which adhere to `ec.simple.SimpleProblemForm`—by far the most common situation—use the following method:

```
public void evaluate(EvolutionState state, Individual ind,  
                    int subpopulation, int threadnum);
```

When this approach is taken, the Problem must assign a fitness immediately during the `evaluate(...)` method. In practice, ECJ doesn't do this all that much.

- The more common approach allows a Problem to perform fitness evaluation in bulk. In this approach, the Evaluator will first call the following method once:

```
public void prepareToEvaluate(EvolutionState state, int thread);
```

This signals to the Problem that it must prepare itself to begin evaluating a series of Individuals, and then afterwards assign fitness to all of them. Next the Evaluator calls the Problem's *evaluation* method for each Individual, typically using the method `evaluate(...)` as before. Finally, the Evaluator calls this method:

```
public void finishEvaluating(EvolutionState state, int thread);
```

Using this approach, the Problem is permitted to delay assigning fitness to Individuals until `finishEvaluating(...)` is called.

When ECJ is preparing to exit various Statistics objects sometimes construct a Problem in order to re-evaluate the fittest Individual of the run, solely to have such evaluation print out useful information to tell the user how the Individual operates. This special version of evaluation is done with the following `ec.simple.SimpleProblemForm` method:

```
public void describe(EvolutionState state, Individual ind, int subpopulation,
                    int threadnum, int log);
```

Note that ECJ will *not* call `prepareToEvaluate(...)` before `describe(...)`, nor call `finishEvaluating(...)` after it. When this method is called, the expectation is that the individual will be evaluated for the purpose of writing out interesting descriptive information to the log. For example, a fit Artificial Ant agent might show the map of the trail it produces as it wanders about eating pellets of food. If you prefer you don't have to implement this method: and in fact many Problems don't. The default version (in `ec.Problem`) does nothing at all.

Problem is a Prototype, and so it must implement the `clone()` (as a deep-clone), `setup(...)`, and `defaultBase()` methods: although in truth the default base is rarely used. Problem's "default" default base is `problem`, which is very rarely used.

3.4.2 Implementing a Problem

Commonly the only method a Problem needs to implement is the `evaluate(...)` method. For example, let's imagine that our Individuals are of the class `ec.vector.IntegerVectorIndividual`, discussed in Section 5.1. The genotype for `IntegerVectorIndividual` is little more than an array of integers. Let us presume that the fitness of these individuals is defined as the product of their integers.

The example below does five basic things:

1. If the individual has already been evaluated, we don't bother evaluating it again. It's possible you'd might want to evaluate it anyway (perhaps if you had a dynamically changing fitness function, for example).
2. We do a sanity check: if the individual is of the wrong type, we issue an error.
3. We compute product of the values in the genome.
4. We set the fitness to that product, and test to see if the fitness is optimal (in this case, if it's equal to `Double.POSITIVE_INFINITY`).
5. We set the individual's evaluated flag.

The implementation is pretty straightforward:

```
package ec.app.myapp;
import ec.*;
import ec.simple.*;
import ec.vector.*;
public class MyProblem extends Problem implements SimpleProblemForm
{
    public void evaluate(EvolutionState state, Individual ind,
                        int subpopulation, int thread)
    {
        if (ind.evaluated) return;

        if (!(ind instanceof IntegerVectorIndividual))
            state.output.fatal("Whoa! It's not an IntegerVectorIndividual!!!");

        int[] genome = ((IntegerVectorIndividual)ind).genome;
        double product = 1.0;

        for(int x=0; x<genome.length; x++)
            product = product * genome[x];

        ((SimpleFitness)ind.fitness).setFitness(state, product,
            product == Double.POSITIVE_INFINITY);
        ind.evaluated = true;
    }
}
```

If you're doing `ec.simple.SimpleProblemForm` may wish to also implement the `describe(...)` method. This method will be called a single time at the end of the run, and will be passed the fittest individual discovered. It gives you a chance to write out interesting statistics about the individual, typically to the statistics log. For example, the `ec/app/ant/Ant.java` file implements the `describe(...)` method to print out the winning path that the ant took to achieve its high fitness. Here is a silly example of implementing `describe(...)` to give you the general idea.

```

public void describe(EvolutionState state, Individual ind,
                    int subpopulation, int thread, int log)
{
    if (!(ind instanceof IntegerVectorIndividual))
        state.output.fatal("Whoa! It's not an IntegerVectorIndividual!!!");

    int[] genome = ((IntegerVectorIndividual)ind).genome;
    double product = 1.0;
    double min = Double.POSITIVE_INFINITY;

    for(int x=0; x<genome.length; x++)
    {
        product = product * genome[x];
        min = Math.min(genome[x], min);
    }

    state.output.println("Best Individual's total: " + product, log);
    state.output.println("Best Individual's minimum genome: " + min, log);
    if (product == Double.POSITIVE_INFINITY)
        state.output.println("Best Individual is OPTIMAL!", log);
    else
        state.output.println("Best Individual is not optimal.", log);
}

```

Notice that `describe(...)` basically looks the same as `evaluate(...)`, except that you always do evaluation (why wouldn't you?), and don't set the fitness (why would you?).

3.5 Breeders

Individuals are selected bred to create new Individuals using a subclass of `ec.Breeder`. Because this is so central to the differences among various evolutionary algorithms, many such algorithms implement their own Breeder subclasses. A Breeder consists of a single method:

```
public abstract Population breedPopulation(EvolutionState state);
```

This method is required to take the current Population, found here...

```
state.population
```

... and return a Population to be used for the next generation, consisting of individuals selected and bred from the previous Population in a manner appropriate for the algorithm being used. The Population returned can be the original Population, or it can be an entirely new Population cloned from the original (Population is a Group, recall — see Section 3.1.5).

The most common Breeder is `ec.simple.SimpleBreeder`, which implements a basic form of generational breeding common to the Genetic Algorithm and to Genetic Programming, among others. `SimpleBreeder` has facilities for multithreaded breeding and a simple form of elitism, and works as follows:

1. For each Subpopulation in the Population,
 - (a) Determine the N fittest Individuals in the Subpopulation.
 - (b) Create a new Subpopulation.
 - (c) Load these N individuals (the “elites”) into first slots of the new Subpopulation’s individuals array.
 - (d) Break the remaining unfilled region of this individuals array into M chunks, one chunk per thread.

- (e) For each of the M threads (in parallel),
 - i. Construct a new Breeding Pipeline.
 - ii. Use this Breeding Pipeline to populate the thread's chunk with newly-bred Individuals.
- 2. Assemble all the new Subpopulations into a new Population and return it.

The number of elites (N) in each Subpopulation is a parameter. To set 10 elites for Subpopulation 0 (for example), you'd say:

```
breed.elite.0 = 10
```

Alternatively you can define the number of elites as a proportion of the Subpopulation:

```
breed.elite-fraction.0 = 0.25
```

You can't do both, but you can do neither: the default value is no elites.

You don't have to specify the elitism on a per-Subpopulation basis. If you specified a default subpopulation using the parameter `pop.default-subpop` (see Section 3.2.1), SimpleBreeder will try this instead when it can't find an elitism parameter, and will issue a warning letting you know it's doing so. For example, if you declared:

```
pop.default-subpop = 0
breed.elite.0 = 10
```

... then when SimpleBreeder must determine elitism for (say) Subpopulation 4, and that parameter doesn't exist, it'll use 10 instead (the value for Subpopulation 0).

Ordinarily elites never have their fitness reevaluated. But if you have a dynamic fitness function, you may wish to reevaluate their fitness each generation to see if it's still the same. To do this for Subpopulation 0, you say:

```
breed.reevaluate-elites.0 = true
```

The default value is false.

Again, you don't have to specify the elitism on a per-Subpopulation basis, if you specified a default subpopulation using the parameter `pop.default-subpop`. SimpleBreeder will use the default value and issue a warning.

The number of threads (M) is also a parameter. To set it to 4, you'd say:

```
breedthreads = 4
```

The default value is a single thread.

As was the case for the `evalthreads` parameter (for Evaluator), recall from Section 2.4 that this will require at least four random number generator seeds, one per thread. For example:

```
seed.0 = 1234
seed.1 = -503812
seed.2 = 992341
seed.3 = -16723
```

Certain Breeders allow you to change the subpopulation breeding order to a *sequential* one. Let's say you have 3 subpopulations. If you turn on the following parameter:

```
breed.sequential = true
```

... then SimpleBreeder will only breed subpopulation 0 the first generation, then only subpopulation 1 the second generation, then only subpopulation 2 the second generation, then only subpopulation 0 the third

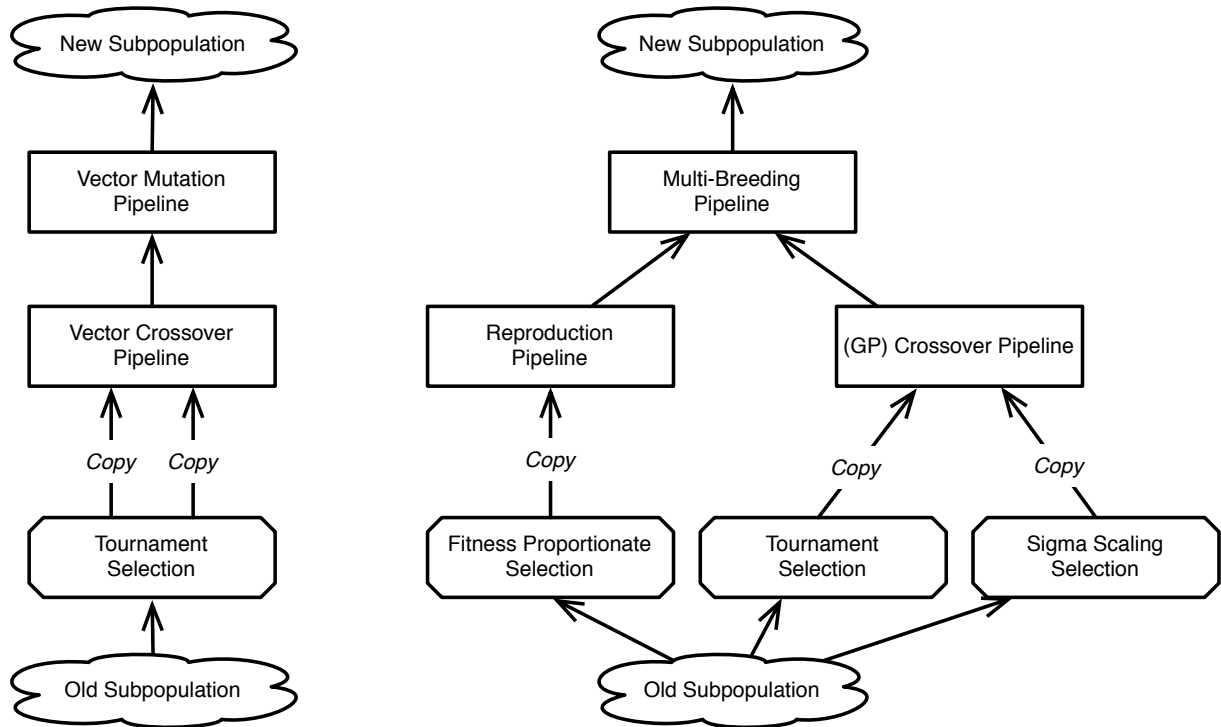

Figure 3.3 Two example Breeding Pipelines.

generation, and so on. Obviously if you only have one subpopulation, this parameter has no effect. Why would you want this? ECJ only uses it for a common kind of coevolution, discussed later in Section 7.1.4.1. Otherwise you should keep this set to `false`. The only reason it's mentioned here is so that if you make a Breeder subclass, you can check for this parameter and signal an error if it is `true`, indicating that your Breeder subclass doesn't support it.

All that remains is the breeding procedure itself, for which SimpleBreeder (and many Breeders) constructs a **Breeding Pipeline**.

Last but not least, if you breed with only one thread ($M = 1$), you have an additional option: to avoid cloning the Population and Pipeline each time. Instead, the same Pipeline will be used each generation; and the breeder will swap back and forth between two Populations each time rather than create new ones. This primarily exists to be a little more efficient in some situations, primarily with small populations. This is done by setting this parameter to `false`:

```
eval.clone-pipeline-and-population = false
```

Obviously, this only is allowed if there's a single evaluation thread. And this option is not supported by a number of subclasses, namely:

- `ec.spatial.SpatialBreeder`
- `ec.multiobjective.nsga2.NSGA2Breeder`
- `ec.multiobjective.spea2.SPEA2Breeder`
- `ec.steadystate.SteadyStateBreeder`

The idea of not cloning the population and pipeline is due to Brian Olsen, a GMU PhD Student.

3.5.1 Breeding Pipelines and BreedingSources

A Breeding Pipeline is a chain of selection and breeding operators whose function is to draw from Individuals in an old Subpopulation to produce individuals in a new Subpopulation.

Breeding Pipelines consist of two kinds of objects. First there are **Selection Methods**, which select Individuals from the old Subpopulation and return copies of them. Then there are **Breeding Pipelines** (what would have better been called *Breeding Operators*), which take Individuals from Selection Methods or from other Breeding Pipelines, modify them in some way, and return them.

The Breeding Pipeline structure isn't actually a *pipeline*: it's really a tree (or in some situations, a directed acyclic graph). The leaf nodes in the graph tree are the Selection Methods (subclasses of `ec.SelectionMethod`), and the nonleaf nodes are the Breeding Pipeline objects (subclasses of `ec.BreedingPipeline`).

Each Breeding Pipeline object can have some N **sources** (children) from which it draws Individuals. Both `ec.SelectionMethod` and `ec.BreedingPipeline` are subclasses of the abstract superclass `ec.BreedingSource`, and so can function as sources for Breeding Pipelines. SelectionMethods do not have sources: rather, they draw Individuals directly from the old Subpopulation.

Breeding Pipelines implement a **copy-forward** protocol: the leaf nodes (SelectionMethods) build clones of individuals selected from the original population, and the non-leaf Breeding Pipeline objects modify those clones. This way every Breeding Pipeline has its own copies of individuals from which it generates children, and so no locks are required on the original population when doing multithreaded breeding.

BreedingSources (and BreedingPipeline, and SelectionMethods) are Prototypes, and so must implement the `clone()`, `defaultBase()`, and `setup(...)` methods. BreedingSources also implement three special methods which perform the actual selection and breeding, which we describe here. When a Breeder wishes to produce a series of new Individuals from an old Subpopulation, it begins by calling the method

```
public abstract void prepareToProduce(EvolutionState state, int subpopulation,
                                     int thread);
```

This instructs the BreedingSource to prepare for a number of requests for Individuals drawn from subpopulation number subpopulation. During this method the BreedingSource will, at a minimum, call `prepareToProduce(...)` on each of its sources.

Next, the Breeder calls the following zero or more times to actually produce the Individuals:

```
public abstract int produce(int min, int max, int subpopulation,
                           java.util.ArrayList<Individual> inds, EvolutionState state,
                           int thread, java.util.HashMap<String, Object> misc);
```

This instructs the BreedingSource to produce between min and max Individuals drawn from subpopulation number subpopulation. The Individuals are to added to the end of the ArrayList inds. Auxiliary information may be found (or placed in) the HashMap misc: see Section 3.5.1.1. Finally the method returns the actual number of Individuals produced.

Last, the Breeder calls the following method to give the BreedingSource an opportunity to clean up. The BreedingSource in turn, at a minimum, will call the same method on each of its sources.

```
public abstract void finishProducing(EvolutionState state, int subpopulation,
                                     int thread);
```

Additionally, BreedingSources implement three other methods. The first:

```
public abstract int typicalIndsProduced();
```

This method returns the number of individuals a BreedingSource would produce by default if not constrained by min and max. The method can return any number > 0 .

The next method:

```
public abstract boolean produces(EvolutionState state, Population newpop,
                                int subpopulation, int thread);
```

... returns true if the BreedingSource believes it can validly produce Individuals of the type described by the given Species, that is, by `newpop.subpops.get(subpopulation).species`. This is basically a sanity check. At the minimum, the BreedingSource should call this method on each of its sources and return false if any of them return false.

Last, we have the hook...

```
public void preparePipeline(Object hook);
```

You don't have to implement this at all. ECJ does not call this method nor implement it in any of its BreedingSources beyond the default implementation (which in BreedingPipeline calls the method in turn on each of its sources). This method simply exists in the case that you need a way to communicate with all the methods of a BreedingPipeline at some unusual time.

3.5.1.1 Auxiliary Data

In addition to Individuals, Breeding Sources can also return various **auxiliary data** associated with them. This is an elaborate hook which lets you do much more sophisticated things with Breeding Sources as your needs may require. This data is stored in the `misc` variable passed into the `produce(...)` method of a Breeding Source.

A Breeder may set `misc` to null, in which case Breeding Sources should simply ignore it. Otherwise `misc` holds a `HashMap` which maps **keyword strings** to **custom objects**, and is created immediately before any call to `produce(...)` by calling the following method in `ec.Species`:

```
public HashMap<String, Object> buildMisc(EvolutionState state, int subpopIndex,
                                         int thread);
```

By default this method just builds an empty `HashMap`.

You can put whatever you want in this `HashMap`. But ECJ currently reserves exactly one keyword string, defined in `SelectionMethod.java`:

```
public static final String KEY_PARENTS = "parents";
```

Associated with this string in the `HashMap` is an array of `ec.util.IntBag` objects. An `IntBag` is very much like an `ArrayList` but it holds ordinary integers, not objects.⁸ For a given individual number x returned in the `ArrayList`, the `IntBag` number x in the `parents` array holds indexes to all the parents of that Individual in the old Subpopulation.

3.5.2 SelectionMethods

Selection Methods by default implement the `typicalIndsProduced()` method to return `SelectionMethod.INDS_PRODUCED` (that is, 1).

Furthermore, the default implementation of the `produces` method,

```
public abstract boolean produces(EvolutionState state, Population newpop,
                                int subpopulation, int thread);
```

...just returns true. But you may wish to use this method to check to make sure that your `SelectionMethod` knows how to work with the kind of Fitnesses found in the given subpopulation, that is, `state.population.subpops.get(subpopulation).f.prototype`.

⁸`IntBag` comes from ECJ's sister project, MASON <https://cs.gmu.edu/~eclab/projects/mason>

The default implementations of `prepareToProduce(...)` and `finishProducing(...)` do nothing at all; though some kinds of `SelectionMethods`, such as `Fitness Proportionate Selection` (`ec.select.FitProportionateSelection`), use `prepareToProduce(...)` to prepare probability distributions based on the Subpopulation in order to select properly.

`SelectionMethods` are sometimes called upon not to produce a cloned `Individual` but to provide an *index* into a subpopulation where the `Individual` is located — perhaps to kill that `Individual` and place another `Individual` in its stead. To this end, `SelectionMethods` have an **alternative form** of the `produce(...)` method:

```
public abstract int produce(int subpopulation, EvolutionState state, int thread);
```

This method must return the index of the selected individual in the Subpopulation given by:

```
state.population.subpops.get(subpopulation).individuals;
```

Furthermore, `SelectionMethods` have a special version of `produce(...)` called `produceWithoutCloning(...)`, which selects individuals (using the alternative form of `produce(...)` as described earlier) and sticks them directly into the `ArrayList` without cloning them.

```
public int produceWithoutCloning(int min, int max, int subpopulation,
                                java.util.ArrayList<Individual> inds, EvolutionState state,
                                int thread, java.util.HashMap<String, Object> misc);
```

At present, `produceWithoutCloning()` does exactly one thing with the `misc` variable: it creates a **parents bag** for each produced child, and places in it the index of the original individual in the old subpopulation.

The default implementation of the full `produce(...)` method just calls `produceWithoutCloning(...)`, then replaces with clones each of the individuals placed in the `ArrayList`. All this means that **you don't have to implement the full `produce(...)` method**. You typically just implement the alternative form (which you have to implement anyway).

3.5.2.1 Implementing a Simple `SelectionMethod`

Implementing a `SelectionMethod` can be as simple as overriding the “alternative” form of the `produce(...)` method. You don't have to implement the “standard” form of `produce(...)` because its default implementation calls the alternative form and handles the rest of the work for you.

To select an individual at random from a Subpopulation, you could simply implement the “alternative” form to return a random number between 0 and the size of the subpopulation in question:

```
public int produce(int subpopulation, EvolutionState state, int thread)
{
    return state.random[thread.next(
        state.population.subpops.get(subpopulation).individuals.size())];
}
```

You'll want to always implement the alternative form of `produce(...)`. But in some cases you may wish to also reimplement the “standard” form of `produce(...)` for some reason (you'll still have to implement the alternative form) —, perhaps you want to play with the `misc` variable, for example. In this case it's best to implement the `produceWithoutCloning(...)` version. We start by determining how many individuals we'll produce, defaulting with 1:

```
public int produceWithoutCloning(int min, int max, int subpopulation, java.util.ArrayList<Individual> inds,
                                EvolutionState state, int thread, java.util.HashMap<String, Object> misc)
{
    int start = inds.size();

    int n = 1;
```

```

if (n>max) n = max;
if (n<min) n = min;

```

Next we select n individuals from the old subpopulation and place them into slots `inds[start] ... inds[start+n-1]`. Here we're do it randomly:

```

for(int q = 0; q < n; q++)
{
    int index = produce(subpopulation,state,thread);
    inds.add(state.population.subpops.get(subpopulation).individuals.get(index));

    // here we will create a parents IntBag for each selected individual, and place
    // the index of that selected individual directly in this IntBag. An array of
    // IntBags are stored associated with KEY_PARENTS.
    // Note that misc could be null, that's perfectly legitimate.
    if (misc!=null && misc.get(KEY_PARENTS)!=null)
    {
        ec.util.IntBag bag = new ec.util.IntBag(1);
        bag.add(index);
        ((IntBag[])misc.get(KEY_PARENTS))[start+q] = bag;
    }

    // Here is where you could play around some more with the misc variable,
    // for example...

}
return n;
}

```

3.5.2.2 Standard Classes

There are a number of standard SelectionMethods available in ECJ, all found in the `ec.select` package.

- `ec.select.FirstSelection` always returns the first individual in the Subpopulation. This is largely used for testing purposes.
- `ec.select.RandomSelection` returns an Individual chosen uniformly at random. Basically it does the same thing as the example given above.
- `ec.select.TopSelection` always returns the very best individual in the Subpopulation, breaking ties randomly. You can optionally *cache* this individual so TopSelection doesn't hunt for him every time it's called. To do this, you set:

```
base.cache = true
```

The default value is false. Note that if multiple individuals are tied for best, only one will be selected for the cache, and the others will never be returned. The cache is reset when the method `prepareToProduce(...)` is called. Warning: in steady-state evolution, this method is only called once, at the beginning of the run. In generational evolution, the method is called at the start of every generation.

- `ec.select.AnnealedSelection` is used for doing Simulated Annealing. It works as follows. If there is only one individual in the population, it is selected. Otherwise we choose a random individual that is *not* the first individual. If that random individual is fitter than the first individual, it is selected. Otherwise if that random individual is *as fit as* (has a fitness equivalent to) the first individual, one of the two is selected at random. Otherwise if the random individual is *not as fit as* the first individual, it is selected

with a probability $P = e^{\frac{\text{Fitness}(\text{the random individual}) - \text{Fitness}(\text{the first individual})}{t}}$, where t is a *temperature*. Otherwise the first individual is selected.

The temperature starts at a high value $\gg 0$, and is slowly cut down by multiplying it by a *cutdown* value every generation. When the temperature reaches 0, then the first individual is always selected. The initial temperature and cutdown are set like this:

```
base.temperature = 10000
base.cutdown = 0.95
```

(You don't have to provide a cutdown, in which case its default is 0.95.)

Like TopSelection, AnnealedSelection also has a caching option. The selected individual can be *cached* so the same individual is returned repeatedly without being recomputed. This cache is cleared after a call to prepareToProduce(...). Again, note that this option is not appropriate for Steady State Evolution, which only calls prepareToProduce(...) once. To do this, you set:

```
base.cache = true
```

The default value is false.

- ec.select.FitProportionateSelection⁹ uses **Fitness-Proportionate Selection**, sometimes called **Roulette Selection**, to pick individuals. Thus ec.select.BestSelection requires that all fitnesses be non-negative.
- ec.select.SUSSelection selects individuals using **Stochastic Universal Sampling**, a low-variance version of Fitness-Proportionate selection in which highly fit individuals are unlikely to *never* be chosen. Every new generation, and M selection events thereafter, it shuffles the Subpopulation, then computes the next M individuals to be selected in the future. ECJ assumes that M is the size of the Subpopulation. Fitnesses must be non-negative. You have the option of whether or not to shuffle the Subpopulation first:

```
base.shuffle = true
```

The default value is false.

- ec.select.SigmaScalingSelection (written by Jack Compton, a former undergraduate at GMU) is another low-variance version of Fitness-Proportionate Selection, in which modified versions of the Individuals' fitnesses are used to reduce the variance among them. This is done by first computing the mean μ and standard deviation σ among the fitnesses. If $\sigma = 0$ no change is made. Otherwise each modified fitness g is then treated as $g \leftarrow 1 + \frac{f - \mu}{2\sigma}$. This can result in negative modified fitnesses, so we introduce a fitness floor: modified fitnesses are bounded to be no less than the floor. Original fitnesses must be non-negative To set this floor to 0.1 (a common value), you'd say:

```
base.scaled-fitness-floor = 0.1
```

0.1 is the default value already, so this is redundant.

SigmaScalingSelection default base is `select.sigma-scaling`.

- ec.select.BoltzmanSelection (also written by Jack Compton) works like Fitness-Proportionate Selection, but uses modified fitness values according to a Boltzman (Simulated-Annealing-style) cooling schedule. Initially BoltzmanSelection has a high *temperature* T , and for each successive generation it decreases T by a *cooling rate* R as $T \leftarrow T * R$. Each modified fitness g is computed as $g \leftarrow e^{f/T}$, where f is the original fitness. Fitnesses must be non-negative. When the temperature reaches 1.0, BoltzmanSelection

⁹It's called FitProportionateSelection rather than FitnessProportionateSelection for a historical reason: MacOS 9 didn't allow filenames longer than 32 characters, and FitnessProportionateSelection.class is 35 characters long.

reverts to `FitnessProportionateSelection`. To set the initial temperature to 1000 and the cooling rate to 0.99, you'd say:

```
base.starting-temperature = 1000
base.cooling-rate = 0.99
```

The default temperature is 1.0; and the default cooling rate is 0.0, which causes `BoltzmanSelection` to behave exactly like `FitProportionateSelection`.

`BoltzmanSelection`'s default base is `select.boltzman`.

- `ec.select.GreedyOverselection` is a variation of Fitness-Proportionate Selection which was common in the early genetic programming community (see Section 5.2), but no longer. The Individuals are sorted and divided into the "fitter" and "less fit" groups. With a certain probability the "fitter" individuals will be selected (using Fitness-Proportionate Selection), else the "less fit" individuals will be selected (also using Fitness-Proportionate Selection). Fitnesses must be non-negative. To specify that the "fitter" group is 25% of the Subpopulation, and that individuals are chosen from it 40% of the time, you'd say:

```
base.top = 0.25
base.gets = 0.40
```

`GreedyOverselection`'s default base is `select.greedy`.

- `ec.select.TournamentSelection` first chooses T individuals entirely at random with replacement (thus the same Individual may be chosen more than once). These individuals are known as the *tournament*, and T is the *tournament size*. Then from among those T it returns the fittest (or least fit, a parameter setting) Individual, breaking ties randomly. T is often an integer but in fact it doesn't have to be: it can be any real-valued number $N > 0$. If T isn't an integer, it's interpreted as follows: with probability $T - \lfloor T \rfloor$ we choose $\lceil T \rceil$ individuals at random, else we choose $\lfloor T \rfloor$ individuals at random. Fitnesses must be non-negative. The most common setting for T is 2. To use 2, and return the fittest individual rather than the least-fit one, say:

```
base.size = 2
base.pick-worst = false
```

By default, `pick-worst` is false, so the second parameter is redundant here.

`TournamentSelection`'s default base is `select.tournament`.

- `ec.select.BestSelection` gathers the best or worst N individuals in the population. It then uses a tournament selection of size T to select, restricted to just those N . The tournament selection procedure works just like `ec.select.TournamentSelection`. If the N worst individuals were gathered, then the tournament will pick the worst in the tournament.

This could be used in various ways. Continuing the example above, to use a value of $T = 2$, selecting among the best 15 individuals in the population (say), we could say:

```
base.n = 15
base.size = 2
base.pick-worst = false
```

We could also use this to always pick the single worst individual in the population:

```
base.n = 1
base.size = 1
base.pick-worst = true
```

Or we could also use this to pick randomly among the best 100 individuals in the population, in a kind of poor-man's (μ, λ) Evolution Strategy (see Section 4.1.2):

```
base.n = 100
base.size = 1
base.pick-worst = false
```

Speaking of Evolution Strategies, you could also do a kind of poor-man's ($\mu + \lambda$) as well by including those top 100 individuals as elites:

```
base.n = 100
base.size = 1
base.pick-worst = false
breed.elite.0 = 100
```

If you don't like specifying n as a fixed value, you also have the option of specifying it as a fraction of the population:

```
base.n-fraction = 0.1
```

You can still use this to do a poor-man's ($\mu + \lambda$) because elitism can likewise be defined this way:

```
base.n-fraction = 0.1
base.size = 1
base.pick-worst = false
breed.elite.0 = 0.1
```

- Finally, `ec.select.MultiSelection` is a special version of a `SelectionMethod` with N other `SelectionMethods` as sources. Each time it must produce an individual, it picks one of these `SelectionMethods` at random (using certain probabilities) and has it produce the Individual instead. To set up `MultiSelection` with two sources, `TournamentSelection` (chosen 60% of the time) and `FitnessProportionateSelection` (chosen 40% of the time), you'd say:

```
base.num-selects = 2
base.select.0 = ec.select.TournamentSelection
base.select.0.prob = 0.60
base.select.1 = ec.select.FitnessProportionateSelection
base.select.1.prob = 0.40
```

`MultiSelection`'s default base is `select.multiselect`.

3.5.3 BreedingPipelines

`BreedingPipelines` (`ec.BreedingPipeline`) take Individuals from sources, typically modify them in some way, and hand them off. Some `BreedingPipelines` are mutation or crossover operators; others are more mundane utility pipelines. `BreedingPipelines` specify the required number of sources they use with the following method:

```
public abstract int numSources();
```

This method must return a value ≥ 0 , or it can return the value `BreedingPipeline.DYNAMIC_SOURCES`, which indicates that the `BreedingPipeline` can vary its number of sources, and that the user must specify the number of sources with the parameter like this:

```
base.num-sources = 3
```

Note: if you use `BreedingPipeline.DYNAMIC_SOURCES`, in the `BreedingPipeline`'s `setup(...)` method, you probably will want to check that the number of sources specified by the user is acceptable. You can do this by checking the size of `sources.length`. For example, the user can specify 0 as a number of sources, which for most pipelines will make little sense.

At any rate, the user specifies each source with a parameter. For example, to stipulate sources 0, 1, and 2, you might say:

```
base.source.0 = ec.select.TournamentSelection
base.source.1 = ec.select.TournamentSelection
base.source.2 = ec.select.GreedyOverselection
```

A diversion. One trick available to you is to state that a source is the same source as a previous one using a special value called `same`. For example, in the example above *two* `TournamentSelection` operators are created. But if you said the following instead:

```
base.source.0 = ec.select.TournamentSelection
base.source.1 = same
base.source.2 = ec.select.GreedyOverselection
```

...then sources 0 and 1 will be the exact same object. This allows you to create a (very simple) Directed Acyclic Graph, or DAG, rather than a tree. There is an even more sophisticated facility for creating DAGs called `StubPipeline` in Section 3.5.3.2. We will not talk about it further here except to say that there is an additional option available to say:

```
base.source.0 = ec.select.TournamentSelection
base.source.1 = stub
base.source.2 = ec.select.GreedyOverselection
```

... and `StubPipeline` will fill the stub in with a pointer to a different pipeline. Note that if you see `stub`, it *must* be the case that `StubPipeline` is somewhere in the ancestors of that parameter's `BreedingPipeline`.

Getting back on track now. At any rate, the sources are then stored in the following instance variable:

```
public BreedingSource[] sources;
```

Some `BreedingPipeline`s, like crossover pipelines, have a very specific number of children they produce by default (the value returned by `typicalIndsProduced()`). However many others (mutation operators, etc.) simply return whatever `Individuals` they receive from their sources. For these, `BreedingPipeline` has a default implementation of `typicalIndsProduced()` which should work fine: it simply calls `typicalIndsProduced()` on all of its sources, and returns the minimum. This computation is done via a simple utility function, `minChildProduction()`, one of two such methods which might be useful to you:

```
public int minChildProduction();
public int maxChildProduction();
```

`BreedingPipeline` has default implementations of the `produces(...)`, `prepareToProduce(...)`, `finishProducing(...)`, and `preparePipeline(...)` methods, all of which call the same methods on the `BreedingPipeline`'s children.

One final option common to most `BreedingPipeline`s which make modifications (mutation, crossover): you can specify the probability that the pipeline will operate at all, or if `Individuals` will simply be passed through. For example, let's say you're using a crossover pipeline of some sort, which creates two children from its sources, then crosses them over and returns them. If you state:

```
base.likelihood = 0.8
```

...then with an 0.8 probability crossover will occur as normal. But with a 0.2 probability two Individuals from the sources will be simply copied and returned, with no crossover occurring.

3.5.3.1 Implementing a Simple BreedingPipeline

To implement a BreedingPipeline, at a minimum, you'll need to override two methods: `numSources()` and `produce(...)`. `numSources()` is easy. Just return the number of sources your BreedingPipeline requires, or `BreedingPipeline.DYNAMIC_SOURCES` if the number can be any size specified by the user (0 and greater). For example, to make a mutation pipeline, we probably want a single source, which we'll extract Individuals from and mutate:

```
public int numSources() { return 1;}
```

If you have chosen to return `BreedingPipeline.DYNAMIC_SOURCES`, you probably want to double-check that the number of sources the user has specified in his parameter file is valid for your pipeline. You can do this in `setup(...)`. For example, the example below verifies that the value is not zero:

```
public void setup(final EvolutionState state, final Parameter base)
{
    super.setup(state,base);
    Parameter def = defaultBase();
    if (sources.length == 0) // uh oh
        state.output.fatal("num-sources must be > 0 for MyPipeline",
            base.push(P_NUMSOURCES), def.push(P_NUMSOURCES));
    ...
}
```

Similarly if you have certain unusual constraints on the nature of your sources (that they are certain classes, for example), you can double-check that in `setup(...)` too.

Now we need to implement the `produce(...)` method. Most mutation procedures ask their sources to produce some number of Individuals for them (however many the source prefers), and then mutate those Individuals and return them. We can ask our source to produce sources like this:

```
public int produce(int min, int max, int subpopulation, ArrayList<Individual> inds,
    EvolutionState state, int thread, HashMap<String, Object> misc)
{
    int start = inds.size(); // this tells us where we started adding individuals
    int n = sources[0].produce(min,max,subpopulation,inds,state,thread,misc);
```

The source has taken the liberty of adding some n individuals to the `inds` ArrayList. Next we need to decide whether to bother mutating at all, based on the `likelihood` parameter. We do a coin-flip to determine this:

```
// should we bother mutating at all?
if (!state.random[thread].nextBoolean(likelihood))
    return n;
```

At this point we're committed to mutating the n Individuals. How mutation occurs depends on the representation of the Individual of course, so we'll fake it with a comment:

```
for(int q=start;q<n+start;q++)
{
    // modify Individual inds.get(q) somehow

    // we probably now want to turn off its evaluated flag now since he's not like his parent
    inds.get(q).evaluated = false;
}
return n;
}
```

3.5.3.2 Standard Utility Pipelines

Most BreedingPipelines are custom for your representation: vectors and trees etc. all have their own special ways of being crossed over or mutated. However there are some utility BreedingPipelines you should be aware of, all stored in the `ec.breed` package:

- `ec.breed.ReproductionPipeline` is by far the most common utility BreedingPipeline. In response to a request for N individuals, `ReproductionPipeline` requests the same number from its single source, then simply returns them (copying if necessary). `ReproductionPipeline` has one rarely-used parameter, which indicates if it *must* copy the individuals even if it's not required to maintain the copy-forward protocol:

```
base.must-clone = true
```

By default, `must-clone` is false.

- Also common is `ec.breed.MultiBreedingPipeline`, which takes some M sources — determined by the user — and when asked to produce Individuals, chooses randomly among its sources to produce the Individuals for it. It then returns those Individuals. This is a common BreedingPipeline used in genetic programming (Section 5.2). Recall that to stipulate the number of sources, you say:

```
base.num-sources = 2
```

Each source can be accompanied with a probability that this source will be chosen. For example, to state that the first Source is a `ReproductionPipeline`, chosen 10% of the time, and that the second is a `VectorCrossoverPipeline`, chosen 90% of the time, we'd say something like:

```
base.source.0 = ec.vector.breed.VectorCrossoverPipeline
base.source.0.prob = 0.90
base.source.1 = ec.breed.ReproductionPipeline
base.source.1.prob = 0.10
```

You can also state that the number of Individuals returned by any source must be exactly the same — specifically, the maximum that any one of them would return in response to a given request. For example, if you had a Crossover pipeline (which normally returns 2 Individuals) and a Reproduction pipeline (which normally returns 1 Individual), you could force both of them to return 2 Individuals if called on. This is done by saying:

```
base.generate-max = true
```

By default, `generate-max` is true, so this is redundant. Note that in Genetic Programming it is common to have a single Crossover pipeline returning 2 Individuals and a Reproduction pipeline returning a single individual, so in the Genetic Programming parameter files, `generate-max` is set to `false`.

- `ec.breed.InitializationPipeline` takes no sources at all: instead it simply generates new random individuals and returns them. It always generates the maximum number requested by its parent. This pipeline is useful for doing random search, for example.
- `ec.breed.BufferedBreedingPipeline` buffers up Individual requests and then hands them out one by one. When you first call `produce()` on a `BufferedBreedingPipeline`, regardless of the number of Individuals requested, it will in turn demand some N children from its single source. It then stores them in a buffer and hands them to this and later `produce()` requests until they are depleted, at which time it requests N more, and so on. This value of N is set like this:

```
base.num-inds = 10
```

Why would you want to do this? Primarily tricks like the following. Let's say you want to create a crossover operator which produces two children, which are then fed into *another* different crossover operator and thus are crossed over *again*. Ordinarily you'd think you could do it along these lines:

```
pop.subpop.0.pipe.0 = ec.app.myCrossover
pop.subpop.0.pipe.0.source.0 = ec.app.myOtherCrossover
pop.subpop.0.pipe.0.source.1 = same
```

Looks good, right? Not so fast. The myCrossover class will request exactly one individual from each of its sources. First it'll request from source 0, which will cross over two children, return one, *and throw away the other*. Then it'll request from source 1, which will again produce two children, return one, and throw away the other. As a result you're not crossing over two individuals twice. You're crossing over different individuals which are the result of separate earlier crossovers.

But if you did it instead like this:

```
pop.subpop.0.pipe.0 = ec.app.myCrossover
pop.subpop.0.pipe.0.source.0 = ec.breed.BufferedBreedingPipeline
pop.subpop.0.pipe.0.source.1 = same
pop.subpop.0.pipe.0.source.0.num-inds = 2
pop.subpop.0.pipe.0.source.0.source.0 = ec.app.myOtherCrossover
pop.subpop.0.pipe.0.source.0.source.1 = same
```

Now myCrossover requests one child from BufferedBreedingPipeline, which in turn demands *two* children from myOtherCrossover, which crosses over two Individuals and returns them. BufferedBreedingPipeline returns one of the Individuals. Then myOtherCrossover requests the second child, and BufferedBreedingPipeline returns the other Individual out of its buffer. Problem solved.

- ec.breed.RepeatPipeline takes a single source. After the method prepareToProduce(...) has been called, it will request a single individual from its source. It will then provide only copies of that individual in response to produce(...) requests. This is useful for selecting a single individual and then (for example) mutating him many times to form children, as is often done in hill-climbing techniques. Warning: in steady-state evolution, prepareToProduce(...) is only called once, at the beginning of the run. In generational evolution, the method is called at the start of every generation.
- ec.breed.ForceBreedingPipeline takes a single source and a parameter num-inds. In response for a request for at least N individuals (minimum), ForceBreedingPipeline will return N individuals, or num-inds individuals, whichever is larger. If num-inds is equal to or larger than N , ForceBreedingPipeline will demand exactly num-inds children from its breeding source, then copy (if necessary) and return them. If N is larger, ForceBreedingPipeline will repeatedly request num-inds children, or (for the final request) fewer than num-inds, in order to satisfy the request for N . For example, if $N = 15$ and num-inds = 4, then ForceBreedingPipeline will request 4, then 4, then 4, then 3 Individuals, then return them all. The parameter of interest is set to some value like:

```
base.num-inds = 5
```

This pipeline gives you a way of either forcing the child pipeline to provide an exact number of individuals at a time. This trick is sort of the counterpart to BufferedBreedingPipeline: it gives you a way of demanding a certain number of individuals from a pipeline (like a CrossoverPipeline) which doesn't normally return that number.

- ec.breed.CheckingPipeline takes two sources, and some N times to produce "valid" individuals from source 0. To verify validity, it calls the method allValid(...), which you override. If it fails after N attempts, it instead produces individuals from source 1 and returns them. The value of N is determined with the parameter:

```
base.num-times = 20
```

The `allValid(...)` method is defined as:

ec.breed.CheckingPipeline Methods

```
public boolean allValid(Individual[] inds, int numInds, int subpopulation, EvolutionState state, int thread)
    Returns whether all of the individuals in inds[0] ... inds[numInds - 1] are valid. Override this to customize
    how CheckingBreedingPipeline checks individuals. By default, this method simply returns true.
```

It may be the case that you wish to produce some N individuals which are checked for validity independently of one another. Probably the easiest way to do this is to set the `CheckingBreedingPipeline` as a child of `ForceBreedingPipeline` whose `num-inds` parameter has been set to 1. For example, you might do something like:

```
pop.subpop.0.pipe.0 = ec.app.myMutation
pop.subpop.0.pipe.0.source.0 = ec.breed.ForceBreedingPipeline
pop.subpop.0.pipe.0.source.0.num-inds = 1
pop.subpop.0.pipe.0.source.0.source.0 = ec.app.myCheckingBreedingPipeline
pop.subpop.0.pipe.0.source.0.source.0.num-times = 20
pop.subpop.0.pipe.0.source.0.source.0.source.0 = ...
```

- `ec.breed.UniquePipeline` tries hard to guarantee that all individuals it produces are different from individual in the past generation's subpopulation. It does this each generation by building a set of individuals in the previous generation's subpopulation, then checks newly generated individuals against this set. If they match, it discards them and tries again.

`UniquePipeline` will try N times to fill a certain requested number of individuals. If it fails after N attempts, it will fill the remainder with non-unique generated individuals. The value of N is determined with the parameter:

```
base.duplicate-retries = 20
```

How many individuals must be generated for `UniquePipeline` to be satisfied? If the following parameter is `true`, then `UniquePipeline` will always fill to the maximum number permitted; else it will fill to at least the minimum number, or whatever its subsidiary pipeline provides it. The default is `false`:

```
base.generate-max = true
```

- `ec.breed.GenerationSwitchPipeline` takes two sources. In response to a request for individuals, for generations 1 through $N - 1$ `GenerationSwitchPipeline` will request Individuals from source 0. For generations N and on, `GenerationSwitchPipeline` will request Individuals from source 1. You specify the switch-generation N as:

```
base.switch-at = 15
```

Like `ReproductionPipeline`, `GenerationSwitchPipeline` can guarantee that both of its sources always return the same number of individuals (the maximum of the two) with:

```
base.generate-max = true
```

By default, `generate-max` is `true`, so this example is redundant.

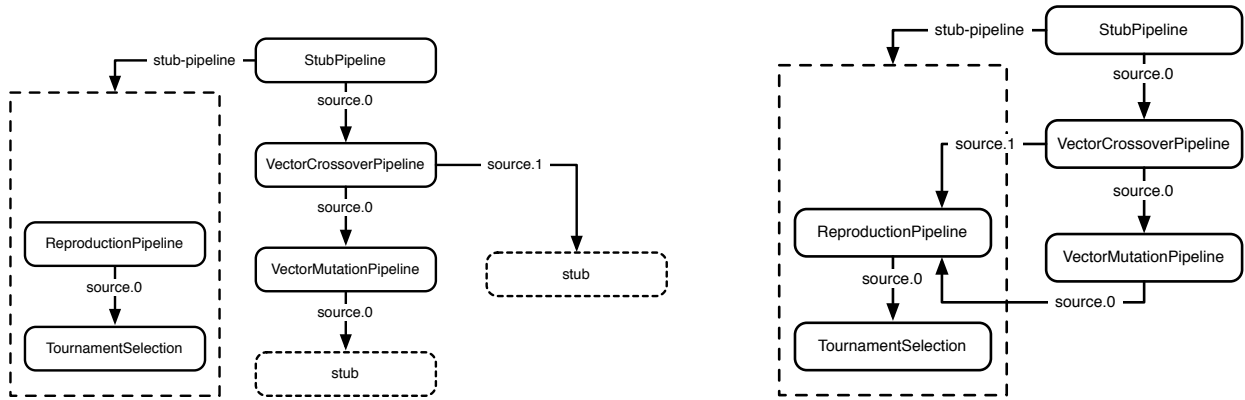

Figure 3.4 Stub Pipeline before (as specified in the parameter file) and after (as constructed). See text.

- `ec.breed.FirstCopyPipeline` is a version of `ReproductionPipeline` but has two sources. Whenever `prepareToProduce(...)` is called, `FirstCopyPipeline` is reset. the immediate next time `produce(...)` is called, `FirstCopyPipeline` will use source #0 to fulfill the very first child produced. Thereafter it use source #1 for all future children (and all future `produce(...)` calls. `prepareToProduce(...)` resets it again. This is useful for performing a simple elitism in a pipeline rather than doing it at the Breeder level.
- Last, `ec.breed.StubPipeline` is a version of `ReproductionPipeline` but includes a special subsidiary pipeline called a *stub pipeline*. If some `BreedingPipeline` which feeds into `StubPipeline`'s source #0 itself contains a source simply called `stub`, then that source location is filled with that `StubPipeline`'s stub pipeline. Each breeding thread gets its own copy of the stub pipeline, but within a thread stub pipelines are not copied. Using `StubPipeline` you can construct elaborate Directed Acyclic Graphs in your Pipeline.

For example, if we had:

```

pop.subpop.0.pipe.0 = ec.breed.StubPipeline
# Here's the stub:
pop.subpop.0.pipe.0.stub-source = ec.breed.ReproductionPipeline
pop.subpop.0.pipe.0.stub-source.source.0 = ec.select.TournamentSelection

pop.subpop.0.pipe.0.source.0 = ec.vector.VectorCrossoverPipeline
pop.subpop.0.pipe.0.source.0.source.0 = stub
pop.subpop.0.pipe.0.source.0.source.1 = ec.vector.VectorMutationPipeline
pop.subpop.0.pipe.0.source.0.source.1.source.0 = stub

```

... then the ECJ would fill the two stubs such that the stub lines would be more or less like this:

```

# First stub
pop.subpop.0.pipe.0.source.0.source.0 = ec.breed.ReproductionPipeline
pop.subpop.0.pipe.0.source.0.source.0.source.0 = ec.select.TournamentSelection

# Second stub -- note that these are the EXACT SAME OBJECTS as in the first stub!
pop.subpop.0.pipe.0.source.0.source.1.source.0 = ec.breed.ReproductionPipeline
pop.subpop.0.pipe.0.source.0.source.1.source.0.source.0 = ec.select.TournamentSelection

```

Figure 3.4 shows the process of building this pipeline from the stub declarations. The critical feature is that the two stubs are replaced with *the same object*, not copies, and thus it's a Directed Acyclic Graph. The procedure is as follows. During `setup(...)` sources declared as a "stub" are not filled: they're set to null. Then after a pipeline has been cloned and handed to a thread to begin breeding, but before `produce(...)` commences, the method `BreedingSource.fillStubs(...)` is called. This recursively traverses

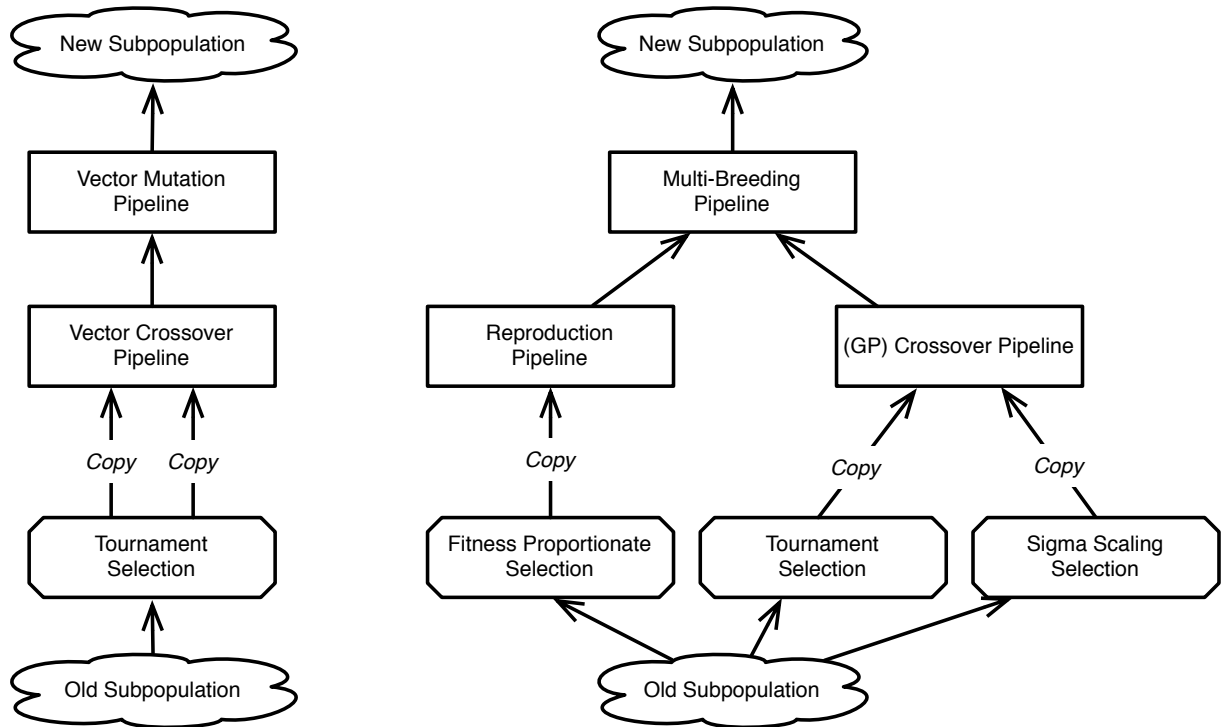

Figure 3.5 Two example Breeding Pipelines (Repeat of Figure 3.3).

through the tree: whenever a StubPipeline receives this method, it fills all the null references in its children with its stub pipeline.

StubPipelines replace all the stubs down to the next StubPipeline (which gets to replace stubs of its own subtree). Additionally it's possible that a stub-pipeline itself contains stubs. In this case, if a StubPipeline A contains a child or descendent StubPipeline B whose stub-pipeline contains stubs, they are filled with StubPipeline A's stub-pipeline before control is handed off to StubPipeline B to start filling.

3.5.4 Setting up a Pipeline

Setting up a pipeline using parameters sometimes isn't entirely obvious. Let's do the two examples shown in Figure 3.5, in both cases setting up a pipeline for Subpopulation 0.

3.5.4.1 A Genetic Algorithm Pipeline

The left figure is a Breeding Pipeline common to the Genetic Algorithm: two Individuals are selected from the old Subpopulation, then copied and crossed over, and the two children are then mutated and added to the new Subpopulation. To build the pipeline, we work our way backwards: first defining the mutator as the top element, then the crossover as its source, then the selector as the crossover's two sources.

First the mutator. We'll use `ec.vector.VectorMutationPipeline`, a common mutator for vector individuals. Subpopulation 0's species holds the prototypical pipeline:

```
pop.subpop.0.species.pipe = ec.vector.VectorMutationPipeline
```

Next we define its sole source: the crossover operator (`ec.vector.VectorCrossoverPipeline`)

```
pop.subpop.0.species.pipe.source.0 = ec.vector.VectorCrossoverPipeline
```

Back to building the Pipeline. Crossover has two sources. We'd like them to both be the Tournament Selector (they could be different Tournament Selectors; it doesn't really matter):

```
pop.subpop.0.species.pipe.source.0.source.0 = ec.select.TournamentSelection
pop.subpop.0.species.pipe.source.0.source.1 = same
```

Tournament Selection has a tournament size operator. Since we're using the same selector for both sources, we only need to set it once:

```
pop.subpop.0.species.pipe.source.0.source.0.size = 2
```

We could also just set the default parameter for all tournament selectors:

```
select.tournament.size = 2
```

Perhaps we'd like the second source to use a tournament size of 4. To do this we'd need to use a separate selector, so we could do this:

```
pop.subpop.0.species.pipe.source.0.source.1 = ec.select.TournamentSelection
pop.subpop.0.species.pipe.source.0.source.1.size = 4
```

This would also override the default we just set, so it'd work whether or not we used the default-setting approach for source 0.

`VectorCrossoverPipeline` and `VectorMutationPipeline`, discussed later, have various parameters; to simplify the pipeline-building procedure, the `ec.vector` package (Section 5.1) puts these parameters in the `Species`, not the pipeline. For completeness sake, let's include some of them here:

```
pop.subpop.0.species = ec.vector.FloatVectorSpecies
pop.subpop.0.species.crossover-type = one
pop.subpop.0.species.mutation-prob = 1.0
pop.subpop.0.species.mutation-type = gauss
pop.subpop.0.species.mutation-stdev = 0.01
```

3.5.4.2 A Genetic Programming Pipeline

The right figure is a typical Genetic Programming pipeline (see Section 5.2). We begin with the root:

```
pop.subpop.0.species.pipe = ec.breed.MultiBreedingPipeline
```

As discussed earlier, `MultiBreedingPipeline` can take any number of sources, so we have to specify it (to 2 here). We also need to state the sources and the probabilities for each source. We'll do 10% Reproduction for the first source and 90% Genetic Programming Crossover for the second. We won't require the two sources to produce the same number of individuals:

```
pop.subpop.0.species.pipe.num-sources = 2
pop.subpop.0.species.pipe.generate-max = false
pop.subpop.0.species.pipe.source.0 = ec.breed.ReproductionPipeline
pop.subpop.0.species.pipe.source.0.prob = 0.10
pop.subpop.0.species.pipe.source.1 = ec.gp.koza.CrossoverPipeline
pop.subpop.0.species.pipe.source.1.prob = 0.90
```

In Genetic Programming nearly *always* we'd use Tournament Selection for all selectors. But we'll do various selectors as shown in the Figure. First the Fitness Proportionate Selection source for the ReproductionPipeline:

```
pop.subpop.0.species.pipe.source.0.source.0 = ec.select.FitProportionateSelection
```

Next TournamentSelection (tournament size 7) as Crossover's first source:

```
pop.subpop.0.species.pipe.source.1.source.0 = ec.select.TournamentSelection
pop.subpop.0.species.pipe.source.1.source.0.size = 7
```

Last, Sigma Scaling Selection as Crossover's second source:

```
pop.subpop.0.species.pipe.source.1.source.1 = ec.select.SigmaScalingSelection
pop.subpop.0.species.pipe.source.1.source.1.scaled-fitness-floor = 0.1
```

(The default setting for `pop.subpop.0.species.pipe.source.1.source.1.scaled-fitness-floor` is already 0.1, so it doesn't really need to be set.)

3.6 Exchangers

An Exchanger is a subclass of `ec.Exchanger`, and is called both before and after breeding. Exchangers form the basis of **Island Models** in ECJ and will be discussed in-depth in Section 6.2.

Besides `setup(...)`, Exchangers have three basic functions, called at different times in the evolutionary cycle:

```
public abstract Population preBreedingExchangePopulation(EvolutionState state);
public abstract Population postBreedingExchangePopulation(EvolutionState state);
public abstract String runComplete(EvolutionState state);
```

The first method is called prior to breeding a population. It's largely available for Island Models to ship off members of the Population to remote ECJ processes. The second method is called immediately *after* breeding a Population, and enables Island Models to import members from remote ECJ processes, possibly displacing newly-bred individuals. The third method is called after `preBreedingExchangePopulation(...)` to determine whether or not the Exchanger thinks ECJ should shut down its process because some *other* process has found the optimal individual. To cause ECJ to shutdown, return a String with a shutdown message of some sort (which will get printed out); otherwise return null.

Unless you're doing Island Models, almost certainly you'll use a default Exchanger called `ec.simple.SimpleExchanger` which does nothing to the Population at all. To wit:

```
exch = ec.simple.SimpleExchanger
```

3.7 Statistics

ECJ provides a large number of **statistics hooks**, places where ECJ will call arbitrary methods on a Statistics object throughout the process. These hooks give you a chance to examine the current process at all sorts of stages and output useful logging information as you see fit. Statistics objects are subclasses of `ec.Statistics` and often follow one or more **statistics forms** which provide different alternative Statistics hooks. For example, `ec.steadystate.SteadyStateStatisticsForm`, discussed later in Section 4.2, stipulates hooks for Statistics in steady-state evolution. The Statistics class `ec.simple.SimpleStatistics` and has hooks for both regular generational evolution (defined in `ec.Statistics`) and `SteadyStateStatisticsForm`. Another basic Statistics class,

ec.simple.SimpleShortStatistics, has hooks only for generational evolution. Other Statistics classes exist, such as those found in Genetic Programming (Section 5.2).

You can have as many Statistics objects as you want, but one Statistics object (usually arbitrarily chosen) must be the **statistics root**. To define an ec.simple.SimpleStatistics as the root, you say:

```
stat = ec.simple.SimpleStatistics
```

Statistics objects usually, but not always, have a **file** which they log their statistics results out to. It's common to stipulate that file as:

```
stat.file = $out.stat
```

This tells SimpleStatistics to write to a file called out.stat, located right where the user launched ECJ (for a reminder on the meaning of the "\$", see Section 2.1.2). If you are running with multiple jobs (Section 2.5), ECJ will automatically append the prefix "jobs.n." to this filename, where *n* is the job number. Thus the statistics file for job number 5 will be "jobs.5.out.stat". If no file is provided, SimpleStatistics will simply print out to the screen.

If ECJ is restarted from a checkpoint, SimpleStatistics will append to existing files rather than overwriting them. SimpleStatistics also has an option to compress the file using GZIP (and thus add a ".gz" suffix at the very end, as in "jobs.5.out.stat.gz". Note that if this option is used, SimpleStatistics will simply overwrite the file if restarted from a checkpoint. The parameter is:

```
stat.gzip = true
```

For each generation, the SimpleStatistics object prints out the best Individual of the generation using the printIndividualForHumans(...) method. For example, generation 0 might have:

```
Generation: 0
Best Individual:
Subpopulation 0:
Evaluated: T
Fitness: -1503.8322
2.4502202187677815 0.9879236448665667 0.7631586426217085 0.6854305126240172
```

If you would like to prevent this per-generational statistics from being written out to the log, you can say:

```
stat.do-generation = false
```

At the end of the run, the SimpleStatistics object prints out the best Individual of the run:

```
Best Individual of Run:
Subpopulation 0:
Evaluated: T
Fitness: -185.78166
-1.0393115193403102 -2.006026366200021 -0.03642166362331428 -1.1196984643947918
```

If you would like to prevent this information from being written to the log, say:

```
stat.do-final = false
```

At the end of the run, the SimpleStatistics object finally calls the describe(...) method on the Evaluator to get it to write out a phenotypical description of the performance of the best individual of the run (see Section 3.4.1). Only some problems implement the describe(...) method: for example the Artificial Ant problem will use it to print out a map of the food trail by the best discovered ant algorithm, such as:

Best Individual's Map

```
=====
acdgf.....f.....m.....
...h.....g.....l.....
...i.....h.....+k##+..
...j.....i.yzabqdefghij...#..
...k.....j.x...pon...#...#..
...lmnopqrstkvw...tmrqp+...+..
.....l.....ul..o....#..
.....mbazyxwvk..n.....+..
.....n.....j..m.....+..
.....o.....i..l....#..
.....p.....h..k....+..
.....q.....g..j....+..
.....r.....f..i....#..
.....s.....e..h....+..
.....t.....d..g++###+..
.....u...+zabc..f.....
.....v...vy....e.....
.....w...ux....d.....
.....x...t....c###+...
.....y...s....b...#...
.....z...r....a...+...
.....a...q....z...+...
.....b...p....y++##+...
.....tc...o....x.....
.wvuts####ud...n....w.....
.x...r....ve...m....v.....
.y...qpo...wf...l...u.....
.z...n###xghijk....t.....
.a....m...y.....s.....
.b....l...z.....r.....
.cdehijk.bcd.....q.....
...fg.....e.....pon.....
```

If you don't want to see stuff like this at the end of your statistics file, say:

```
stat.do-description = false
```

SimpleStatistics can also call `describe(...)` to print out stuff like this every generation, for the best individual of that generation. For backwards-compatibility reasons by default it's turned *off*. To turn it on, say:

```
stat.do-per-generation-description = true
```

Finally, SimpleStatistics will also write out a message (see Section 2.2) to `stdout`, which prints to the screen some short statistical information about each generation. For example:

```
Initializing Generation 0
Subpop 0 best fitness of generation Fitness: Standardized=63.0 Adjusted=0.015625 Hits=26
Generation 1
Subpop 0 best fitness of generation Fitness: Standardized=57.0 Adjusted=0.01724138 Hits=32
Generation 2
Subpop 0 best fitness of generation Fitness: Standardized=48.0 Adjusted=0.020408163 Hits=41
Generation 3
Subpop 0 best fitness of generation Fitness: Standardized=48.0 Adjusted=0.020408163 Hits=41
Generation 4
Subpop 0 best fitness of generation Fitness: Standardized=40.0 Adjusted=0.024390243 Hits=49
Generation 5
Subpop 0 best fitness of generation Fitness: Standardized=38.0 Adjusted=0.025641026 Hits=51
...
```

If you would prefer not to see this information, just say:

```
stat.do-message = false
```

... and what you'll get on the screen will be:

```
Initializing Generation 0
Generation 1
Generation 2
Generation 3
Generation 4
Generation 5
...
```

3.7.1 Creating a Statistics Chain

So how do you add additional Statistics objects? As children of the root, or of one another. Any Statistics object can have some n children. Children are called the same hooks as their parents are. To add another Statistics object (say, `ec.simple.SimpleShortStatistics`), we might add a child to the root:

```
stat.num-children = 1
stat.child.0 = ec.simple.SimpleShortStatistics
stat.child.0.file = $out2.stat
```

Notice that the file has changed: you don't want both Statistics objects writing to the same file! If we wanted to add a third Statistics object (say, another `ec.simple.SimpleShortStatistics`), we could do it this way:

```
stat.num-children = 2
stat.child.0 = ec.simple.SimpleShortStatistics
stat.child.0.file = $out2.stat
stat.child.1 = ec.simple.SimpleShortStatistics
stat.child.1.file = $out3.stat
```

...or we could do it this way:

```
stat.num-children = 1
stat.child.0 = ec.simple.SimpleShortStatistics
stat.child.0.file = $out2.stat
stat.child.0.num-children = 1
stat.child.0.child.0 = ec.simple.SimpleShortStatistics
stat.child.0.child.0.file = $out3.stat
```

The point is, you can hang a Statistics object as a child of any other Statistics object. Pick your poison.

3.7.2 Tabular Statistics

`SimpleShortStatistics` writes out a different kind of statistics from `SimpleStatistics`. In its basic form, for each generation it writes out a line of the following values, each separated by a space.

1. The generation number
2. The mean fitness of the entire population for this generation
3. The best fitness of the entire population for this generation
4. The best fitness of the entire population so far in the run

For example, we might have values like this...

```
0 -1851.9916400146485 -1559.68 -1559.68
1 -1801.2400487060547 -1557.7627 -1557.7627
2 -1758.2322434082032 -1513.4955 -1513.4955
3 -1715.5276463623047 -1420.0074 -1420.0074
4 -1675.379030883789 -1459.842 -1420.0074
5 -1637.332774291992 -1426.798 -1420.0074
...
```

You can add sizing information as well. If you set:

```
stat.child.0.do-size = true
```

... you'll get

1. The generation number
2. (If `do-size` is true) The average size of an individual this generation
3. (If `do-size` is true) The average size of an individual so far in the run
4. (If `do-size` is true) The size of the best individual this generation
5. (If `do-size` is true) The size of the best individual so far in the run
6. The mean fitness of the entire population for this generation
7. The best fitness of the entire population for this generation
8. The best fitness of the entire population so far in the run

You can also turn on timing information. If you set:

```
stat.child.0.do-size = true
stat.child.0.do-time = true
```

You'll additionally get:

1. The generation number
2. (If `do-time` is true) How long initialization took in milliseconds, or how long the previous generation took to breed to form this generation
3. (If `do-time` is true) How long evaluation took in milliseconds this generation
4. (If `do-size` is true) The average size of an individual this generation
5. (If `do-size` is true) The average size of an individual so far in the run
6. (If `do-size` is true) The size of the best individual this generation
7. (If `do-size` is true) The size of the best individual so far in the run
8. The mean fitness of the entire population for this generation
9. The best fitness of the entire population for this generation
10. The best fitness of the entire population so far in the run

Finally, you can add in per-subpopulation information. If you set:

```
stat.child.0.do-size = true
stat.child.0.do-time = true
stat.child.0.do-subpops = true
```

you get the whole shebang:

1. The generation number
2. (If `do-time` is true) How long initialization took in milliseconds, or how long the previous generation took to breed to form this generation
3. (If `do-time` is true) How long evaluation took in milliseconds this generation
4. *Once for each subpopulation...*
 - (a) (If `do-size` is true) The average size of an individual this generation for this subpopulation
 - (b) (If `do-size` is true) The average size of an individual so far in the run for this subpopulation
 - (c) (If `do-size` is true) The size of the best individual this generation for this subpopulation
 - (d) (If `do-size` is true) The size of the best individual so far in the run for this subpopulation
 - (e) The mean fitness of the subpopulation for this generation
 - (f) The best fitness of the subpopulation for this generation
 - (g) The best fitness of the subpopulation so far in the run
5. (If `do-size` is true) The average size of an individual this generation
6. (If `do-size` is true) The average size of an individual so far in the run
7. (If `do-size` is true) The size of the best individual this generation
8. (If `do-size` is true) The size of the best individual so far in the run
9. The mean fitness of the entire population for this generation
10. The best fitness of the entire population for this generation
11. The best fitness of the entire population so far in the run

Restricting Rows with a Modulus If you've got a lot of subpopulations, or very long runs, there's another way you can reduce the size of your file: only output results ever n generations. For example, if we had set

```
stat.child.0.modulus = 2
```

.. then the aforementioned statistics would look like this:

```
0 -1851.9916400146485 -1559.68 -1559.68
2 -1758.2322434082032 -1513.4955 -1513.4955
4 -1675.379030883789 -1459.842 -1420.0074
...
```

An important thing to keep in mind. Let's say you want to run for 1000 generations and gather the last. Thus your generations are 0 through 999. If you did a modulus of 100 (say), your reported results would be for generations 0, 100, 200, 300, 400, 500, 600, 700, 800, and 900. That is, you'd have lost the last 99 generations, including the final generation. How might you fix this? The easiest way is to simply run for 1001 generations. Then your last reported generation will be 1000.

3.7.3 Quieting the Statistics

Many statistics objects have options to prevent them from either writing to the screen, or creating statistics logs, or both. Because statistics classes vary in the kinds of files they write, the options they have for quieting them vary from class to class.

Basic subclasses of `SimpleStatistics` (such as `ec.simple.SimpleStatistics`, `ec.simple.SimpleShortStatistics`, and `ec.gp.koza.KozaShortStatistics`) allow you to do any of the following:

- Not print to the screen
- Not create statistics logs or print to them
- Both of the above

To do any of these with the first Statistics object in the Statistics chain, you'd say:

```
# Pick one of these:

# Turn off printing to the screen
stat.silent.print = true

# Do not create statistics logs (don't even open them)
stat.silent.file = true

# Do both of the above
stat.silent = true
```

Obviously for other Statistics objects in your chain, it's slightly different. For example, to do the same to the first child object in the chain, you might say:

```
# Pick one of these:

# Turn off printing to the screen
stat.child.0.silent.print = true

# Do not create statistics logs (don't even open them)
stat.child.0.silent.file = true

# Do both of the above
stat.child.0.silent = true
```

You should be made aware of the important difference between these parameters and the “do-...” parameters discussed earlier in Sections 5.2.3.5 and 3.7.2. The “do-...” parameters control what *kinds* of messages will be written out to logs or to the screen. Whereas the “silent” parameters are much cruder: they control whether *anything* will be written at all. Note that the “do-...” parameters don't prevent statistics files from being opened or created, even if nothing is written to them. However the “silent” parameters will stop the files from even being opened or created in the first place.

Also note the relationship between these “silent” parameters and the `silent` parameter from Section 2.2.2. That second parameter cuts off the `stderr` and `stdout` streams entirely, preventing anything from being written to the screen; it takes precedence over the settings of the “silent” parameters in this section.

3.7.4 Implementing a Statistics Object

A basic Statistics object implements one or more of the following hooks:

```

public void preInitializationStatistics(EvolutionState state);
public void postInitializationStatistics(EvolutionState state); // Generational
public void preCheckpointStatistics(EvolutionState state);
public void postCheckpointStatistics(EvolutionState state);
public void preEvaluationStatistics(EvolutionState state); // Generational
public void postEvaluationStatistics(EvolutionState state); // Generational
public void prePreBreedingExchangeStatistics(EvolutionState state);
public void postPreBreedingExchangeStatistics(EvolutionState state);
public void preBreedingStatistics(EvolutionState state); // Generational
public void postBreedingStatistics(EvolutionState state); // Generational
public void prePostBreedingExchangeStatistics(EvolutionState state);
public void postPostBreedingExchangeStatistics(EvolutionState state);
public void finalStatistics(EvolutionState state, int result);

```

When these statistics hooks are called should be self-explanatory from the method name. Note that the methods marked Generational are only called by generational EvolutionState objects—notably the ec.simple.SimpleEvolutionState object. There are also some additional hooks called by the ec.steadystate package for steady-state evolution (see Section 4.2.1).

The finalStatistics(...) method, called at the end of an evolutionary run, contains one additional argument, result. This argument will be either ec.EvolutionState.R_SUCCESS or ec.EvolutionState.R_FAILURE. Success simply means that the optimal individual was discovered, and nothing more.

Whenever you override one of these methods, make certain to call super(...) first. Let's say that we'd like to know what the size is of the very first individual created after initialization. We might create a Statistics subclass which overrides this to print this size out to the screen:

```

public void postInitializationStatistics(EvolutionState state)
{
    super.postInitializationStatistics(state); // always call this
    state.output.println(state.population.subpops.get(0).individuals.get(0).size(), 0); // stdout
}

```

We could also write to a file, but to do so we'd need to determine the file name. We could do it in a manner similar to SimpleStatistics (ignoring the compression):

```

public static final String P_STATISTICS_FILE = "file";
public int log = 0; // 0 by default means stdout

public void setup(final EvolutionState state, final Parameter base)
{
    super.setup(state, base);
    File statisticsFile = state.parameters.getFile(base.push(P_STATISTICS_FILE), null);
    if (statisticsFile != null) try
    {
        log = state.output.addLog(statisticsFile, true, false, null, false);
    }
    catch (IOException i)
    {
        state.output.fatal("An IOException occurred trying to create the log "
            + statisticsFile + ":\n" + i);
    }
    // else we'll just keep the log at 0, which is stdout
}

```

Now we can write out to the log:

```

public void postInitializationStatistics(EvolutionState state)
{
    super.postInitializationStatistics(state); // always call this
    state.output.println(state.population.subpops.get(0).individuals.get(0).size(), log);
}

```

3.8 Debugging an Evolutionary Process

A hint. One helpful way to debug ECJ is via BeanShell (<http://www.beanshell.org>). This tool is essentially a command-line for Java. Using it, we can create an ECJ process and get it going quite easily. Let's say that the parameter file is called "foo.params". We can type the following into BeanShell:

```

show();
import ec.*;
args = new String[] { "-file", "foo.params" };
database = Evolve.loadParameterDatabase(args);
state = Evolve.initialize(database, 0);
state.run(EvolutionState.C_STARTED_FRESH);
Evolve.cleanup(state);

```

This is basically a variation of the main code found in Section 2.5. When `state.run(...)` is executed, ECJ will go through the entire evolutionary run. It turns out that `state.run(...)` is really just a cover for three methods (at least, if we're starting from scratch rather than from a checkpoint). They are: first calling `state.startFresh()`, then repeatedly calling `state.evolve()`, and when it returns something other than `state.R_NOTDONE`, finally calling `state.finish(...)`, passing in what was returned. In other words:

```

show();
import ec.*;
args = new String[] { "-file", "foo.params" };
database = Evolve.loadParameterDatabase(args);
state = Evolve.initialize(database, 0);
state.startFresh();
result = EvolutionState.R_NOTDONE;
while( result == EvolutionState.R_NOTDONE )
{
    result = state.evolve();
}
state.finish(result);
Evolve.cleanup(state);

```

So how can we use this for debugging? Well, BeanShell gives us full access to Java. Let's try it on the `ecsuite.params` file. We begin with the preliminaries:

```

show();
import ec.*;
args = new String[] { "-file", "ecsuite.params" };

```

BeanShell responds with:

```
<[Ljava.lang.String;@39617189>
```

This is the String array. We continue with:

```
database = Evolve.loadParameterDatabase(args);
```

BeanShell responds with the ParameterDatabase:

```
<{} : ({} : ({eval=ec.simple.SimpleEvaluator, pop.subpop.0=ec.Subpopulation,
quit-on-run-complete=true, generations=1000,
pop.subpop.0.species.pipe.source.0=ec.vector.breed.VectorCrossoverPipeline,
pop.subpop.0.species.min-gene=-5.12, eval.problem=ec.app.ecsuite.ECSuite,
state=ec.simple.SimpleEvolutionState, pop.subpop.0.species.mutation-type=gauss,
pop=ec.Population, pop.subpop.0.duplicate-retries=2, select.tournament.size=2,
pop.subpops=1, pop.subpop.0.species.mutation-stdev=0.01,
pop.subpop.0.species.pipe=ec.vector.breed.VectorMutationPipeline,
pop.subpop.0.species.max-gene=5.12, pop.subpop.0.species.pipe.source.0.source.1=same,
pop.subpop.0.species.pipe.source.0.source.0=ec.select.TournamentSelection,
pop.subpop.0.species=ec.vector.FloatVectorSpecies, breed=ec.simple.SimpleBreeder,
pop.subpop.0.species.mutation-prob=1.0, pop.subpop.0.species.genome-size=100,
pop.subpop.0.species.crossover-type=one, finish=ec.simple.SimpleFinisher,
parent.0=../ec.params, init=ec.simple.SimpleInitializer,
pop.subpop.0.species.ind=ec.vector.DoubleVectorIndividual,
pop.subpop.0.species.fitness=ec.simple.SimpleFitness, pop.subpop.0.size=1000,
eval.problem.type=rastrigin, stat=ec.simple.SimpleStatistics,
exch=ec.simple.SimpleExchanger, stat.file=$out.stat} : ({checkpoint-modulo=1,
evalthreads=1, checkpoint=false, breedthreads=1, checkpoint-prefix=ec, seed.0=time}))>
```

Now we initialize the EvolutionState from the database:

```
state = Evolve.initialize(database, 0);
```

This causes ECJ to start printing to the screen something along these lines:

```
| ECJ
| An evolutionary computation system (version 19)
| By Sean Luke
| Contributors: L. Panait, G. Balan, S. Paus, Z. Skolicki, R. Kicinger, E. Popovici,
|               K. Sullivan, J. Harrison, J. Bassett, R. Hubley, A. Desai, A. Chircop,
|               J. Compton, W. Haddon, S. Donnelly, B. Jamil, and J. O'Beirne
| URL: http://cs.gmu.edu/~eclab/projects/ecj/
| Mail: ecj-help@cs.gmu.edu
|       (better: join ECJ-INTEREST at URL above)
| Date: July 10, 2009
| Current Java: 1.6.0_20 / Java HotSpot(TM) 64-Bit Server VM-16.3-b01-279
| Required Minimum Java: 1.4
```

```
Threads: breed/1 eval/1
Seed: 1853290822
<ec.simple.SimpleEvolutionState@1f5b0afd>
```

Notice the last line — BeanShell is returning the EvolutionState. Now we fire up the EvolutionState to initialize the first population:

```
state.startFresh();
```

... and get back:

Setting up
Initializing Generation 0

The first population has been created. Let's look at the first Individual:

```
state.population.subpops.get(0).individuals.get(0);
```

This produces:

```
<ec.vector.DoubleVectorIndividual@87740549{699618236}>
```

Not very helpful. Instead, let's have it printed:

```
state.population.subpops.get(0).individuals.get(0).printIndividualForHumans(state, 0);
```

This produces something more useful:

```
Evaluated: F  
Fitness: 0.0  
-4.3846934361930945 4.051323475292111 2.750742781209575 -2.1599970035296088  
3.5139838195638236 -4.326431483145531 -1.5799722524229094 -4.64489169381555  
-4.809825694271426 -0.6969239813124668 -4.322411553562226 4.8723307904232565  
2.8978088843319947 -4.311437772193992 -1.556903048013028 2.876699531303326  
-1.5461627480422133 -3.406470106152458 0.3510231690045371 -1.26870148662141  
-2.9943682283832675 -1.1321325429409796 -4.780798908878881 -2.789054768098288  
2.7957975471728034 -2.4529277934521363 0.06864524959557006 -2.807030901927618  
-3.817734647565329 3.0018199187738803 3.893346256074625 -4.1700250768556355  
-3.3035366716916714 -1.5300889532287534 -1.2924365390313826 2.6878356877535623  
4.344108056131552 1.0732802812225044 1.804809997034555 0.6627493849916508  
1.6556742582736854 -3.8324177646471913 0.2901815515514814 -0.5045301890375606  
-2.755111883054377 -4.057309896490254 -2.097059222061862 -2.062611078568839  
3.676980437590175 3.4010063830636517 5.001876654997903 2.3637174851440808  
-2.3242430228722846 -0.2027490501614988 4.948796285958214 3.645393286308912  
-0.9981883696957627 -2.4911201811073296 2.281601570422807 -3.0028177298996583  
-0.6949487749058276 2.4115725052273005 2.2705630820859133 3.8198793397976756  
3.927188087275849 3.5439728479577974 4.195897069928313 4.064291914283307  
-1.6071055662352376 -0.45138576561254506 0.5382601925283925 2.2824947546503687  
-0.0837300863613164 -2.4997930740673895 0.06696037058102089 1.782243737261787  
-3.390249634178219 4.669336185081783 2.371290190775591 1.8743739255868377  
0.13349732700681827 2.808175830805574 -4.2297879656940705 -0.5781599273148448  
3.4174595199606577 2.5509508748123793 0.9574470878471297 1.181916131827328  
3.3128918249657184 3.5085201808925843 -0.8921840350705308 -4.016933626993176  
2.5591127486976983 1.580181276449899 -0.6102226049991097 1.0644092417475743  
0.5897983455130262 2.5504671849586904 -2.230897886457403 1.8133759722806326
```

Now we're getting somewhere. You could print out all the individuals like this:

```
for(int i = 0; i < state.population.subpops.get(0).individuals.size(); i++)  
    state.population.subpops.get(0).individuals.get(i).printIndividualForHumans(state, 0);
```

... but I won't torture you with what comes out. Instead, notice that the Individual has not been evaluated yet—just initialized with the Population. We go through one evolutionary loop—evaluating the individuals and breeding a new Population—by calling

```
state.evolve();
```

This produces:

```
Subpop 0 best fitness of generation: Fitness: -1493.534
<2>
```

The first line was printed to the screen. The second line indicates what `state.evolve()` returned. 2 is the value of `EvolutionState.R_NOTDONE`, indicating that the process needs to be evolved more.

Let's look at that first individual again:

```
state.population.subpops.get(0).individuals.get(0).printIndividualForHumans(state, 0);
```

...yielding...

```
Evaluated: F
Fitness: -1806.1432
-1.5595820609909528 -2.9941135630034292 -3.188550961391961 0.8673223056511647
2.4308132097811472 -3.6298006589453533 -4.62193495641744 1.7381186900517611
-3.2707539202577953 -2.8517369832386144 -4.701099579700639 1.1683479248633841
0.10118833856168477 2.7982137159130787 -1.3673458253800685 -4.548719487000453
-1.7852252742508177 -1.662999422245311 -4.891889992368657 2.0689413066938824
4.64815452362056 4.03620579726471 -2.6065781548997413 2.8384398494616585
-1.6231723965539844 -0.19641152832494305 -0.8025430015631594 -4.337733534634894
-4.259188069209607 0.0974585410674078 4.878006291864429 4.187577755641656
3.9507153065207605 -3.3456633008586922 3.7163666200189596 -0.7581028665673978
4.28299933455259 1.8522464455693997 4.4324032846812935 -1.3209545115697914
4.239911043319335 -2.7741200087506352 -3.181419981396656 -0.4574562816089688
3.9209870275697982 0.31049605413333237 -0.46868091240064014 -4.570530964131764
-0.9126484738704782 3.6348709305820153 -1.800821491837854 -0.8548399118205554
-1.6874962921883667 2.628667604603462 0.060377157894385663 3.194354857448187
1.2106237734207714 -3.477534436566739 1.919326547065771 -3.748805179122247
4.076653684533312 -2.9153006121227034 -2.4460232838375973 0.6128610868842217
0.7785108819209824 -1.213371979065718 3.2441049504290587 -1.352037820951835
1.151316091162472 0.3915293759690397 -0.15229424767569708 1.8192706794904545
-3.057866603248519 -3.2217378304635926 3.7963181147558447 1.9609441782591566
2.1365399986514815 -0.7608502832241196 -1.2202190662246202 -3.2592371482282956
-2.612971504172355 3.1496849987738167 -5.083084415090031 -4.243405086300351
3.8516939433487387 -4.87008846122508 1.012854792831603 3.77728764346906
2.843506550933032 4.705462097924235 1.4291349248648448 3.8398215224809875
1.1776568359195472 -4.784524531392207 2.765230136436807 -2.6521295800350555
-2.271480494878218 -2.018481022639772 -2.2536397207045686 -1.5048357519436404
```

It's a different Individual: the next generation one to be exact. Notice that although it has a "fitness", in fact it's not been evaluated: the "fitness" is just nonsense cloned from a previous Individual.

So how do you see a population with fitness-evaluated Individuals? Generational ECJ EvolutionState processes assess the fitness of a Population, then create a new Population and throw away the old one. You can hold onto the old Population pretty easily. Just do this:

```
p = state.population;
state.evolve();
```

Now `p` holds the old Population, filled with now-evaluated Individuals, and `state.population` holds the next-generation Population, which hasn't been evaluated yet. For example, if you say:

```
p.subpops[0].individuals.get(0).printIndividualForHumans(state, 0);
```

... you will get back something like this:

Evaluated: T

Fitness: -1779.4391

-1.5595820609909528 -2.9941135630034292 -3.188550961391961 0.8673223056511647
2.4308132097811472 -3.6298006589453533 -4.62193495641744 1.7381186900517611
-3.2707539202577953 -2.8517369832386144 -4.701099579700639 1.1683479248633841
0.10118833856168477 2.7982137159130787 -1.3673458253800685 -4.548719487000453
-1.7852252742508177 -1.662999422245311 -4.891889992368657 2.0689413066938824
4.64815452362056 4.03620579726471 -2.6065781548997413 2.8384398494616585
-1.6231723965539844 -0.19641152832494305 -0.8025430015631594 -4.337733534634894
-4.259188069209607 0.0974585410674078 4.878006291864429 4.187577755641656
3.9507153065207605 -3.3456633008586922 3.7163666200189596 -0.7581028665673978
4.28299933455259 1.8522464455693997 4.4324032846812935 -1.3209545115697914
4.239911043319335 -2.7741200087506352 -3.181419981396656 -0.4574562816089688
3.9209870275697982 0.31049605413333237 -0.46868091240064014 -4.570530964131764
-0.9126484738704782 3.6348709305820153 -1.800821491837854 -0.8548399118205554
-1.6874962921883667 2.628667604603462 0.060377157894385663 3.194354857448187
1.2106237734207714 -3.477534436566739 1.919326547065771 -3.74880517912247
4.076653684533312 -2.9153006121227034 -2.4460232838375973 0.6128610868842217
0.7785108819209824 -1.213371979065718 3.2441049504290587 -1.352037820951835
1.151316091162472 0.3915293759690397 -0.15229424767569708 1.8192706794904545
-3.057866603248519 -3.2217378304635926 3.7963181147558447 1.9609441782591566
2.1365399986514815 -0.7608502832241196 -1.2202190662246202 -3.2592371482282956
-2.612971504172355 3.1496849987738167 -5.083084415090031 -4.243405086300351
3.8516939433487387 -4.87008846122508 1.012854792831603 3.77728764346906
2.843506550933032 4.705462097924235 1.4291349248648448 3.8398215224809875
1.1776568359195472 -4.784524531392207 2.765230136436807 -2.6521295800350555
-2.271480494878218 -2.018481022639772 -2.2536397207045686 -1.5048357519436404

Notice that this Individual has been evaluated. Its Fitness is valid.

For more on debugging ECJ, see Section 2.1.7.

Chapter 4

Basic Evolutionary Processes

4.1 Generational Evolution

ECJ is most commonly used for generational evolution: where a whole Population is evaluated, then updated, at a time. There are a number of packages which use generational evolution, but the two most common are the `ec.simple` package, which does Genetic Algorithm style generational evolution, and the `ec.es` package which does Evolution Strategies.

Generations and Evaluations Generational Evolution, of course, has *generations*. A generation is one iteration of the top-level evolutionary loop. It also has *evaluations*, which is the number of times an individual has been (potentially) assigned a fitness. By *potentially* we mean that if an individual could have been tested, but the Problem chose not to because the individual had already been assessed (its evaluated flag was raised), this *still counts as an evaluation*.

When the population does not change in size (which is often the case), the number of generations transpired is equal to the number of evaluations times the total size of the population. But when the population size changes, this relationship is no longer necessarily true.

The generational facility will run until one of two events has happened:

- The *maximum number of generations* has been exceeded.
- The *maximum number of evaluations* has been exceeded. ECJ will then continue evaluating individuals until it hits the next generation boundary, at which point it quits. For example, let's say that your system is supposed to run for seven evaluations, but in fact you a total population size of four, so your generation boundary is every four individuals. When seven evaluations has been reached, there's still one more individual left in the population to be evaluated before the next generation boundary. ECJ will thus evaluate *eight* individuals.

You specify the maximum number of generations as:

```
generations = 100
```

ECJ will set the `SimpleEvolutionState.numGenerations` variable to be set to this value (100).

You specify the maximum number of evaluations as:

```
evaluations = 10000
```

ECJ will set the `SimpleEvolutionState.numEvaluations` variable to this value (10000).

You must specify one or the other of these. If you specify *both* of them, then you will get a warning that either event could occur and ECJ can't predict which one will happen first.

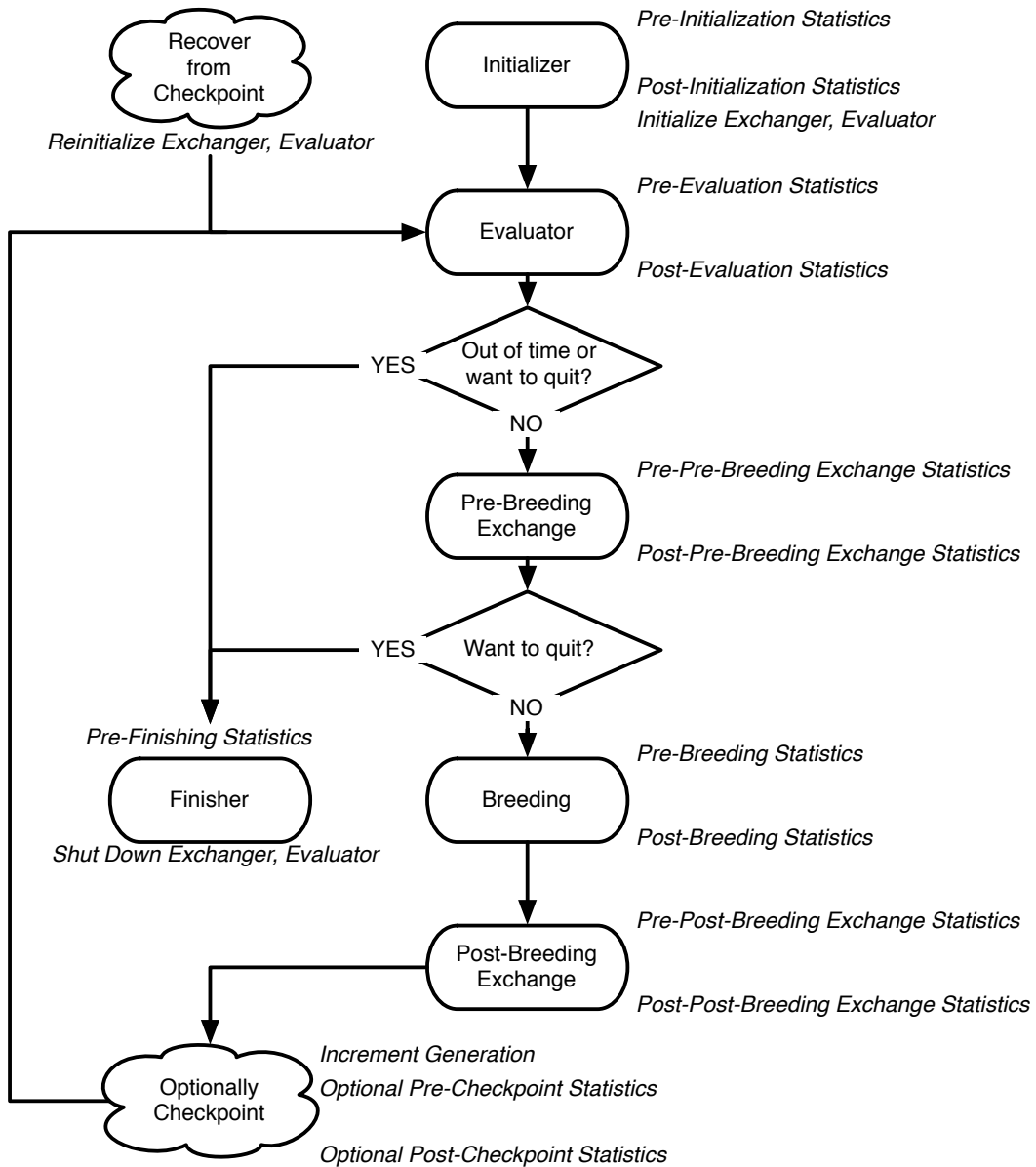

Figure 4.1 Top-Level Loop of ECJ's SimpleEvolutionState class, used for basic generational EC algorithms. Various sub-operations are shown occurring before or after the primary operations. The full population is revised each iteration. A repeat of Figure 1.1.

The current generation is stored in the variable `EvolutionState.generation`, and is updated on a generation boundary. The current number of evaluations is stored in the variable `EvolutionState.evaluation`, and is updated. Note that these variables will only be updated on a generation boundary.

4.1.1 The Genetic Algorithm (The `ec.simple` Package)

We've pretty much covered everything in the `ec.simple` package throughout Section 3. But just a quick reminder:

- `ec.simple.SimpleEvolutionState` subclasses `ec.EvolutionState` to provide the generational top-level loop shown in Figure 4.1. Each generation the entire Population is handed to the Evaluator, then the Breeder. The class adds no new parameters beyond those defined in `EvolutionState`.
- `ec.simple.SimpleBreeder` subclasses `ec.Breeder` to provide multithreaded breeding and elitism. `SimpleBreeder` was discussed at length in Section 3.5.
- `ec.simple.SimpleEvaluator` subclasses `ec.Evaluator` to provide multithreaded evaluation. `SimpleEvaluator` adds no new parameters beyond those defined in `Evaluator`, and was discussed at length in Section 3.4.
- `ec.simple.SimpleFitness` subclasses `ec.Fitness` to provide a simple fitness consisting of a double floating-point number, where higher fitness values are preferred. `SimpleFitness` also holds a boolean flag indicating whether the fitness assigned is the optimal fitness. `SimpleFitness` adds no new parameters beyond those defined in `Fitness`, and was discussed at length in Section 3.2.5.
- `ec.simple.SimpleProblemForm` defines the kind of methods which must be implemented by Problems used by a `SimpleEvaluator`, and was discussed at length in Section 3.4.1. As a reminder, the two methods defined by `SimpleProblemForm` are `evaluate(...)`, which evaluates an individual and sets its fitness; and `describe(...)`, which evaluates an individual solely for the purpose of writing a detailed description about the individual's performance out to a stream. They look like this:

```
public void evaluate(EvolutionState state, Individual ind,
                    int subpopulation, int threadnum);
public void describe(EvolutionState state, Individual ind,
                    int subpopulation, int threadnum, int log);
```

- `ec.simple.SimpleInitializer` subclasses `ec.Initializer` to provide multithreaded breeding and elitism. `SimpleInitializer` adds no new parameters beyond those defined in `Initializer`, and was discussed at length in Section 3.3.
- `ec.simple.SimpleFinisher` subclasses `ec.Finisher` and does nothing at all. `SimpleFinisher` was discussed at length (so to speak) in Section 3.3.
- `ec.simple.SimpleExchanger` subclasses `ec.Exchanger` and does nothing at all. `SimpleExchanger` was mentioned in Section 3.6.
- `ec.simple.SimpleStatistics` subclasses `ec.Statistics` and outputs the best-of-generation individual each generation, plus the best-of-run individual at the end. `SimpleStatistics` was discussed at length in Section 5.2.3.5.
- `ec.simple.SimpleShortStatistics` subclasses `ec.Statistics` and gives numerical statistics about the progress of the generation. `SimpleStatistics` was also discussed at length in Section 5.2.3.5.
- `ec.simple.SimpleDefaults` implements `ec.DefaultsForm` and provides the package default parameter base.

An Example Let's put these together to do a simple genetic algorithm. We start with the basic parameters:

```
# Threads and Seeds
evalthreads = 1
breedthreads = 1
seed.0 = time

# Checkpointing
checkpoint = false
checkpoint-modulo = 1
checkpoint-prefix = ec
```

Next a basic generational setup:

```
# The basic setup
state = ec.simple.SimpleEvolutionState
init = ec.simple.SimpleInitializer
finish = ec.simple.SimpleFinisher
exch = ec.simple.SimpleExchanger
breed = ec.simple.SimpleBreeder
eval = ec.simple.SimpleEvaluator
stat = ec.simple.SimpleStatistics
pop = ec.Population

# Basic parameters
generations = 200
quit-on-run-complete = true
pop.subpops = 1
pop.subpops.0 = ec.Subpopulation
pop.subpop.0.size = 1000
pop.subpop.0.duplicate-retries = 0
breed.elite.0 = 0
stat.file = $out.stat
```

We'll use Individuals of the form `ec.vector.IntegerVectorIndividual`, discussed later in Section 5.1. This is not much more than a cover for a one-dimensional array of integers:

```
# Representation
pop.subpops.0.species = ec.vector.IntegerVectorSpecies
pop.subpop.0.species.ind = ec.vector.IntegerVectorIndividual
pop.subpop.0.species.genome-size = 100
```

For fitness, we'll use `SimpleFitness`:

```
# Fitness
pop.subpop.0.species.fitness = ec.simple.SimpleFitness
```

In Section 3.5.4 we laid out a simple Genetic Algorithm Pipeline:

```
# Pipeline
pop.subpop.0.species.pipe = ec.vector.VectorMutationPipeline
pop.subpop.0.species.pipe.source.0 = ec.vector.VectorCrossoverPipeline
pop.subpop.0.species.pipe.source.0.source.0 = ec.select.TournamentSelection
pop.subpop.0.species.pipe.source.0.source.1 = same
select.tournament.size = 2
```

Because they are so common, Vector pipelines are unusual in that they define certain probabilities in

Species rather than in the Pipeline, mostly for simplicity. We haven't discussed these yet (we'll get to them in Section 5.1), but here's one possibility:

```
pop.subpop.0.species.crossover-type = one
pop.subpop.0.species.mutation-prob = 0.01
```

In Section 3.4.2 we defined a simple Problem in which the fitness of an IntegerVectorIndividual was the product of the integers in its genome. Let's use it here.

```
package ec.app.myapp;
import ec.*;
import ec.simple.*;
import ec.vector.*;
public class MyProblem extends Problem implements SimpleProblemForm
{
    public void evaluate(EvolutionState state, Individual ind,
                        int subpopulation, int thread)
    {
        if (ind.evaluated) return;

        if (!(ind instanceof IntegerVectorIndividual))
            state.output.fatal("Whoa! It's not an IntegerVectorIndividual!!!");

        int[] genome = ((IntegerVectorIndividual)ind).genome;
        double product = 1.0;

        for(int x=0; x<genome.length; x++)
            product = product * genome[x];

        ((SimpleFitness)ind.fitness).setFitness(state, product,
            product == Double.POSITIVE_INFINITY);
        ind.evaluated = true;
    }
}
```

Now we state that we're using this class:

```
eval.problem = myapp.MyProblem
```

... and we're ready to go! Save out as the file `ga.params`, we then run ECJ as:

```
java ec.Evolve -file ga.params
```

4.1.2 Evolution Strategies (The `ec.es` Package)

The `ec.es` package implements basic versions of the (μ, λ) and $(\mu + \lambda)$ algorithms. Since it's also generational, it largely depends on and extends the `ec.simple` package. The way these algorithms are done is via special Breeders: the aptly named `ec.es.MuCommaLambdaBreeder` and `ec.es.MuPlusLambdaBreeder`. These work in conjunction with a specially formulated Selection operator called `ec.es.ESSelection`.

Evolution Strategies differs from the Genetic Algorithm mostly in that it does **truncation selection**: an entire segment of the Population (all but the best μ) is simply lopped off, and breeding occurs among the remainder. ECJ does this by having `ESSelection` only select among the best μ Individuals in the Population. In truncation selection, each remaining Individual gets the same number of opportunities to breed. `ESSelection` works with the two Breeders to guarantee this: each time the BreedingPipeline is pulsed for an individual,

the parent has been pre-determined by the Breeder, and ESSelection simply returns that parent.

ESSelection doesn't have to be the only selection operator in your BreedingPipeline: you can have various other ones. But you should have at *least* one ESSelection operator in your pipeline, else it just isn't Evolution Strategies any more. Also note that ESSelection always returns the Individual pre-determined by the Breeder: thus if you have multiple ESSelection operators in your pipeline, they will *all* return that same Individual.¹

(μ, λ) This evolution strategy is implemented by the MuCommaLambdaBreeder. The μ variable stipulates the number of parents left after truncation selection has lopped off the population. The λ variable stipulates how many children are generated by the μ parents in total. Each Individual in the μ gets to produce exactly $\frac{\lambda}{\mu}$ children. Obviously μ must divide evenly into λ . Often λ is also the initial population size: but this doesn't have to be the case. If not, it will be the population size of the second and later generations.

This MuCommaLambdaBreeder has two parameters, which, not surprisingly, specify the values of μ and λ in a given Subpopulation. For Subpopulation 0, this will provide $\mu = 1$ and $\lambda = 10$, to make a (10, 100) Evolution Strategy.

```
breed = ec.es.MuCommaLambdaBreeder
es.mu.0 = 10
es.lambda.0 = 100
```

You have the option of not specifying λ . If you do so, then λ will be set to the subpopulation size. Furthermore, if $\mu > \frac{\lambda}{2}$ (the largest possible value of μ) then you will receive a warning and μ will be set to $\frac{\lambda}{2}$. If you don't like defining μ this way, alternatively you can define μ as a fraction of λ :

```
es.mu-fraction = 0.25
```

$(\mu + \lambda)$ This algorithm differs from (μ, λ) in that, after creating the children, the μ parents join the λ children to form the next generation Population. Thus the next generation is $\mu + \lambda$ in size. Again, the initial population can be any size (traditionally I think it's $\mu + \lambda$). The MuPlusLambdaBreeder subclasses MuCommaLambdaBreeder and adds no new parameters, though you'd change the Breeder of course:

```
breed = ec.es.MuPlusLambdaBreeder
```

$(\mu + \lambda)$ has different maximum values of μ than (μ, λ) does. As a result, in $(\mu + \lambda)$, if $\mu > \lambda$ (the largest possible value of μ) then you will receive a warning and μ will be set to λ .

It's common in Evolution Strategies to use a mutation-only pipeline. Here's one:

```
pop.subpop.0.pipe = ec.vector.VectorMutation
pop.subpop.0.pipe.source.0 = ec.es.ESSelection
```

Last but not least, ec.es.ESDefaults provides the package default parameter base.

Example We build off of the example shown in Section 4.1.1, so let's use that file:

```
parent.0 = ga.params
```

Next, let's override some parameters to use Evolution Strategies:

¹For fun, note the relationships between these techniques and the options provided in ec.select.BestSelection (Section 3.5.2.2).

```

breed = ec.es.MuCommaLambdaBreeder
es.mu.0 = 10
es.lambda.0 = 100
pop.subpop.0.pipe = ec.vector.VectorMutation
pop.subpop.0.pipe.source.0 = ec.es.ESSelection

```

Evolution Strategies also often uses a floating-point array representation. The Genetic Algorithm example in Section 4.1.1 used an integer array representation. We could change it to an array of Doubles like this:

```

pop.subpop.0.species = ec.vector.FloatVectorSpecies
pop.subpop.0.species.ind = ec.vector.DoubleVectorIndividual

```

IntegerVectorIndividual has a simple default mutator: randomizing the integers. This is why the mutation-prob is set low (to 0.01). Since we're using floating-point values, let's change the mutation type to gaussian mutation with a standard deviation of 0.01, happening 100% of the time:

```

pop.subpop.0.species.mutation-type = gauss
pop.subpop.0.species.mutation-stdev = 0.01
pop.subpop.0.species.mutation-prob = 1.0

```

Since we're using a different representation, we need to change our Problem a bit:

```

package ec.app.myapp;
import ec.*;
import ec.simple.*;
import ec.vector.*;
public class MySecondProblem extends Problem implements SimpleProblemForm
{
    public void evaluate(EvolutionState state, Individual ind,
                       int subpopulation, int thread)
    {
        if (ind.evaluated) return;

        if (!(ind instanceof DoubleVectorIndividual))
            state.output.fatal("Whoa! It's not an DoubleVectorIndividual!!!");

        double[] genome = ((DoubleVectorIndividual)ind).genome;
        double product = 1.0;

        for(int x=0; x<genome.length; x++)
            product = product * genome[x];

        ((SimpleFitness)ind.fitness).setFitness(state, product,
        product == Double.POSITIVE_INFINITY);
        ind.evaluated = true;
    }
}

```

Finally, we set the problem:

```

eval.problem = ec.app.myapp.MySecondProblem

```

... and we're ready to go! Save out the file as es.params, and then run ECJ as:

```

java ec.Evolve -file es.params

```

4.2 Steady-State Evolution (The `ec.steadystate` Package)

In Steady-state Evolution, each iteration some n individuals are bred from the existing Population, have their fitnesses assessed, and then are stuck back in the Population, displacing n others. ECJ's implementation of Steady-State Evolution sets $n = 1$, which is the most common case.

To implement Steady-State Evolution ECJ requires special versions of: an EvolutionState, a Breeder, and an Evaluator:

```
state = ec.steadystate.SteadyStateEvolutionState
breed = ec.steadystate.SteadyStateBreeder
eval = ec.steadystate.SteadyStateEvaluator
```

Additionally Breeding Sources must adhere to certain rules, as must Exchangers and Statistics.

ECJ's top-level Steady-State Evolution loop, implemented in the class `ec.steadystate.SteadyStateEvolutionState`, is shown in Figure 4.2. Compare to Figure 4.1, which shows a generational loop. At this abstract level, the two are very similar: the primary differences lie in the Statistics methods called. But inside the Breeder and Evaluator there are some significant differences. One important detail: Steady-State Evolution *must* at present be single-threaded:

```
evalthreads = 1
breedthreads = 1
```

`SteadyStateEvolutionState` can either run until some n evaluations have been processed, or until some m "generations" have been processed, like this:

```
generations = 100
```

What does a "generation" mean in this context? ECJ sums up the sizes of all of the subpopulations to form the *total population size* p . Whenever p individuals have been evaluated, that's a new generation.

Normally `SteadyStateEvolutionState` uses generations. If you'd prefer to work in evaluations, you can say something like this:

```
evaluations = 10000
```

ECJ will still treat a "generation" as p worth of individuals being evaluated. Note that, unlike was the case for generational evolution, the number of evaluations does not have to be a multiple of p : when evaluations number of individuals have been evaluated, the process terminates. However, evaluations, if you set it, does have to be at least as big as the total initial population size.

Steady-State evolution in ECJ works in two stages:

- **Stage 1: Initialization.** The Subpopulation begins completely empty. One-by-one, individuals are created at random and then sent off to be evaluated. In Steady-State evolution, this evaluation happens immediately and each individual is returned immediately. However in a distributed version called Asynchronous Evolution (discussed in Section 6.1), individuals are shipped off to remote sites and may not come back for a while. In this case evolution does not wait for them, but continues generating new individuals.

When an individual returns with its fitness assessed, it then is added to the Subpopulation until the Subpopulation is full, at which time the system advances to...

- **Stage 2: The Steady State.** One-by-one, individuals are *bred* and then sent off to be evaluated. Again, in Steady-State evolution, this evaluation happens immediately and each individual is returned immediately. However in Asynchronous Evolution individuals are shipped off to remote sites and may not come back for a while. In this case evolution does not wait for them, but continues breeding new individuals.

When an individual returns with its fitness assessed, an existing Subpopulation member is marked for death. With a certain probability the marked-for-death individual is directly replaced with the new individual; else it is replaced by the new individual only if the new individual's fitness is superior. Note that if using Asynchronous Evolution, some of these new individuals may be stragglers created during Initialization.

These stages aren't immediately obvious from Figure 4.2: they're distinguished by both "Is the Subpopulation Full?" branches.

The Evaluator in question is `ec.steadystate.SteadyStateEvaluator`, which has no special parameters.

The Breeder in question is `ec.steadystate.SteadyStateBreeder`. It contains the `SelectionMethod` which is used to select individuals for death. Typically this `SelectionMethod` is set up to select *unfit* or *random* individuals rather than *fit* ones (which wouldn't make much sense). To pick an unfit individual using Tournament Selection for Subpopulation 0, for example, we might say:

```
steady.deselector.0 = ec.select.TournamentSelection
steady.deselector.0.size = 2
steady.deselector.0.pick-worst = true
```

To pick a random individual, you could change this to

```
steady.deselector.0.size = 1
```

...or you could just use...

```
steady.deselector.0 = ec.select.RandomSelection
```

Once an individual has been selected for death, we determine to what degree the new incoming individual must compete with it for its spot in the population. This is done with an `EvolutionState` parameter. Let's say we want the incoming individual to *always* have to compete with the existing individual for the existing individual's spot in the population. We'd do:

```
% No direct replacement -- must always compete
steady.replacement-probability = 0.0
```

Alternatively we could just dump in the new individual every time, displacing the individual marked for death:

```
% No competition. Always directly replace
steady.replacement-probability = 1.0
```

This is **the default** if you don't provide a parameter setting, and it's reasonable for ordinary Steady-State Evolution: but it's probably not smart if you're doing Asynchronous Evolution (See Section 6.1) with a large number of processors relative to the population size. And of course you could have any probability value in-between:

```
% With 0.15 probability, directly replace, and with 0.85, require competition
steady.replacement-probability = 0.15
```

All `BreedingSources` in your breeding pipeline, and in particular `SelectionMethods`, must implement `ec.steadystate.SteadyStateBSourceForm`. This interface contains a method called to update the `BreedingSource` that a new individual has entered into the population, displacing an old one. This is important because some `SelectionMethods`, such as `FitProportionateSelection`, rely on precomputed statistics which will be no longer correct. This method is:

```
public void individualReplaced(SteadyStateEvolutionState state,
                              int subpopulation, int thread, int individual);
```

At the very least, a `BreedingSource` must implement this method to call the same method on *its* sources. This means that they must be of `SteadyStateBSourceForm` as well. To guarantee this, the following check method must be implemented:

```
public void sourcesAreProperForm(SteadyStateEvolutionState state);
```

This method should likewise call its namesake on all sources. If the sources are not of `SteadyStateBSourceForm`, it should then issue an ordinary Output “error” (not a fatal error) indicating this problem.

`SteadyStateBSourceForm` is implemented by all `BreedingPipelines`. Further, it is implemented by the following `SelectionMethods`:

```
ec.select.RandomSelection      Random Selection (Section 3.5.2.2)
ec.select.TournamentSelection  Tournament Selection (Section 3.5.2.2)
ec.select.FirstSelection       First Selection (Section 3.5.2.2)
ec.parsimony.BucketTournamentSelection  Bucket Tournament Selection (Section 5.2.12)
ec.parsimony.DoubleTournamentSelection  Double Tournament Selection (Section 5.2.12)
ec.parsimony.RatioTournamentSelection  Ratio Tournament Selection (Section 5.2.12)
```

You can implement `SteadyStateBSourceForm` for other `SelectionMethods`, such as `FitProportionateSelection` and its ilk, but it’s not implemented by default because they’d be so inefficient. I strongly suggest sticking with `TournamentSelection`.

Exchangers are called every *generation* worth of evaluations. Since Exchangers also modify individuals in the population, they also need to update the `BreedingSources` of this fact. This is done by having them call the following method in the `Breeder`, which lets all the relevant `BreedingSources` know:

```
public void individualReplaced(SteadyStateEvolutionState state,
                              int subpopulation, int thread, int individual);
```

(Yes, it’s the same name). If an Exchanger makes this promise, it gets to implement the `ec.steadystate.SteadyStateExchangerForm` interface as a badge of honor.

Last but not least, `ec.steadystate.SteadyStateDefaults` provides the package default parameter base.

Example We again build off of the example shown in Section 4.1.1, and continue to use generation boundaries rather than evaluations to keep things simple. So let’s use that file:

```
parent.0 = ga.params
```

Steady-State evolution doesn’t allow multiple threads:

```
evalthreads = 1
breedthreads = 1
```

Next, let’s override some parameters to use Steady-State Evolution:

```
state = ec.steadystate.SteadyStateEvolutionState
breed = ec.steadystate.SteadyStateBreeder
eval = ec.steadystate.SteadyStateEvaluator
```

Traditionally, steady-state evolutionary algorithms try hard not to produce duplicates during initialization:

```
steady.duplicate-retries = 100
```

We'll need to specify a deselector for each supopulation too. Let's do random selection:

```
steady.deselector.0 = ec.select.ec.select.RandomSelection
```

...and we're done! We don't bother changing the Statistics object. SimpleStatistics will do in a pinch when we're observing generation boundaries. But if you'd like to create a Statistics subclass which is a bit more useful in the steady-state case, we come to....

4.2.1 Steady State Statistics

The steady state nature of evolution requires a different set of Statistics hooks. These hooks are defined in the interface `ec.steadystate.SteadyStateStatisticsForm`. Note that no ECJ Statistics class presently implements these hooks; but `SteadyStateEvolutionState` can handle non-`SteadyStateStatisticsForm` Statistics objects gracefully.

Several hooks you've already seen in Section 5.2.3.5:

```
public void preCheckpointStatistics(EvolutionState state);
public void postCheckpointStatistics(EvolutionState state);
public void prePreBreedingExchangeStatistics(EvolutionState state);
public void postPreBreedingExchangeStatistics(EvolutionState state);
public void prePostBreedingExchangeStatistics(EvolutionState state);
public void postPostBreedingExchangeStatistics(EvolutionState state);
public void finalStatistics(EvolutionState state, int result);
```

Other hooks are special to steady-state evolution. First, we have:

```
public void enteringInitialPopulationStatistics(SteadyStateEvolutionState state);
public void enteringSteadyStateStatistics(int subpop, SteadyStateEvolutionState state);
public void generationBoundaryStatistics(EvolutionState state);
```

The first method is called immediately after the Population has been constructed but before any Individuals have been created. The second method is called when a Subpopulation enters its "steady state", that is, it has been filled with Individuals. The third method is called whenever a generation boundary is reached, that is, when a Population's worth of individuals has been evaluated.

Last, we have two hooks which are called whenever an individual is bred or evaluated:

```
public void individualsBredStatistics(SteadyStateEvolutionState state,
                                     Individual[] individuals);
public void individualsEvaluatedStatistics(SteadyStateEvolutionState state,
                                           Individual[] newIndividuals, Individual[] oldIndividuals,
                                           int[] subpopulations, int[] indices);
```

The first method is called when one or more Individuals has just been bred (at present only one individual will be bred at a time). The second method is called when one or more Individuals have just been evaluated and inserted into the Population, dispersing other Individuals (at present, it'll only be one individual evaluated). The Subpopulations and Individual indices in the Subpopulations where the event occurred are provided as well.

4.2.2 Producing More than One Individual at a Time

The Steady-State system is at present designed to breed, evaluate, and replace one individual at a time. This is the typical scenario, and it also makes perfect sense if you're doing Asynchronous Evolution (Section 6.1).

But let's say you're using some form of crossover to breed this individual. Crossover makes two children, and you're throwing one away. What if you want to insert both kids into the population? How can you do this?

One way is to use `ec.breed.BufferedBreedingPipeline` (see Section 3.5.3.2). The idea here is that the breeding pipeline will still be asked to produce only one individual at a time; but it will in fact produce *two* individuals, return one of them, and store the other. When asked again for another single individual, it'll return the stored individual. It'll repeat this process as necessary.

For example, consider the following pipeline:

```
pop.subpop.0.species.pipe = ec.vector.breed.VectorMutationPipeline
pop.subpop.0.species.pipe.likelihood = 1.0
pop.subpop.0.species.pipe.source.0 = ec.vector.breed.VectorCrossoverPipeline
pop.subpop.0.species.pipe.source.0.likelihood = 0.9
pop.subpop.0.species.pipe.source.0.source.0 = ec.select.TournamentSelection
pop.subpop.0.species.pipe.source.0.source.1 = same
```

If we used this pipeline in Steady-State evolution, the pipeline would be forced to generate only a *single* individual at a time, even though by default it'd make two individuals (due to the crossover) and return them. The other individual would simply be discarded.

We can change this to retain that second individual like this:

```
pop.subpop.0.species.pipe = ec.breed.BufferedBreedingPipeline
pop.subpop.0.species.pipe.num-inds = 2
pop.subpop.0.species.pipe.likelihood = 1.0
pop.subpop.0.species.pipe.source.0 = ec.vector.breed.VectorMutationPipeline
pop.subpop.0.species.pipe.source.0.likelihood = 1.0
pop.subpop.0.species.pipe.source.0.source.0 = ec.vector.breed.VectorCrossoverPipeline
pop.subpop.0.species.pipe.source.0.source.0.likelihood = 0.9
pop.subpop.0.species.pipe.source.0.source.0.source.0 = ec.select.TournamentSelection
pop.subpop.0.species.pipe.source.0.source.0.source.1 = same
```

This pipeline would only return one individual at a time, but in the process it would build two individuals (from crossover), and put one aside, returning the other. When asked again for another individual, it'd return the stored individual, then repeat.

All fine and good, but there's a catch. Recall that steady-state evolution first breeds *one* individual (storing it in abeyance); then it evaluates that *one* individual and inserts it into the population. This means that using this revised pipeline, things would go like this (two iterations):

1. The pipeline would be requested to return an individual.
2. Two individuals A and B would be generated. B would be stored and A would be returned.
3. A would be evaluated, and replace some individual in the population.
4. The pipeline would be again requested to return an individual.
5. B would be immediately returned.
6. B would be evaluated, and replace some individual in the population. **That individual might be A.**

It's a small probability: $1/\text{subpopsize}$. But it can happen. If you don't like this, we'd need to significantly modify Steady-State evolution. We can do it but it's not high on the list. If you need it higher on the list, send us mail.

It's worth noting that this is all possible because, unlike generational evolution, steady-state evolution only generates one breeding pipeline and continues to use it throughout the run. Were we to try this trick with generational evolution, the `BufferedBreedingPipeline` would be destroyed each generation, including any kids presently in its buffer.

4.3 Single-State Methods (The `ec.singlestate` Package)

In contrast to evolutionary methods, which maintain a Population of Individuals at a time, Single-State methods typically maintain just one or two individuals. Though they may spawn many individuals at a time, they'll whittle them back down to just one or two. Examples of single-state methods include variations on Hill-Climbing and Simulated Annealing.

You can of course implement single-state methods in a population context, and so you *could* just use `SimpleEvolutionState` and be done with it. However, `SimpleEvolutionState` has a lot of overhead per iteration. The goal in the `SingleState` package is to reduce this overhead considerably because iterations are numerous.

To implement a Single-State method you will need a special `EvolutionState` and a special `Breeder`. You can have multithreaded evaluation (if you use `SteadyStateEvaluator` for example) but you can only have single-threaded breeding.

```
state = ec.singlestate.SingleStateEvolutionState
breed = ec.singlestate.SingleStateBreeder
breedthreads = 1
```

In a `SingleState` method you'd most commonly use generations as your measure of progress, though you could also use evaluations. One chief difference is that, like checkpoints, statistics and exchanges are also only performed once every n generations. Additionally, this modulo value for the exchanges and checkpoints should be a multiple of the value for the statistics. For example, if you have statistics performed every 5 generations, exchanges must be done every 10, 15, or 20 generations (etc.) but not 7 or 3. Typically you'd set these to pretty high values:

```
stats-modulo = 1000
checkpoint-modulo = 10000
exchange-modulo = 10000
```

A number of single-state methods have an elitism of 1: the original best individual is propagated forward. `SingleStateBreeder` supports elitism but only for 1, not for larger numbers. To turn on elitism in subpopulation 0 you'd say:

```
breed.elite.0 = true
```

Additionally, some single-state methods begin with an initial subpopulation of a given size, then change it to a different size for future generations. `SingleStateBreeder` supports this. For example, if you had a single subpopulation initially of size 1 but then changing to size 2, you could do this

```
pop.subpop.0.size = 1
breed.expanded-subpop-size.0 = 2
```

`SingleStateBreeder` also supports the same **default subpopulation** mechanism as `SimpleBreeder`; and both of these parameters will be looked up in the default subpopulation if they do not appear for a given subpopulation.

4.3.1 Simple Hill-Climbing and (1+1)

Hill-climbing works as follows:

1. Build a subpopulation of size 1
2. Loop g times:
 - (a) Test all individuals in the subpopulation
 - (b) Create the next subpopulation, of size 2

- (c) Select the best individual in the old subpopulation, and add to the next subpopulation
- (d) Fill the remaining slot with an individual copied and mutated from the best individual

The Evolution Strategies method $(1 + 1)$ is the same, with the caveat that the mutation is global: it must in theory be able to produce any child from any parent.

Note that this method (1) starts with a subpopulation of size 1 but changes it to 2 later (2) has elitism and (3) breeds a child from the elitist individual. We will do these things as follows. First, we handle the change of subpopulation size:

```
pop.subpop.0.size = 1
breed.expanded-subpop-size.0 = 2
```

Next we add elitism:

```
breed.elite.0 = true
```

Finally, to grab the best individual from the previous subpopulation efficiently, we use `ec.select.TopSelection`, for example, something like:

```
pop.subpop.0.species.pipe = ec.vector.breed.VectorMutationPipeline
pop.subpop.0.species.pipe.source.0 = ec.select.TopSelection
```

We'll make the modulus big and run for, say, 100000 generations:

```
generations = 100000
checkpoint-modulo = 10000
stats-modulo = 10000
exchange-modulo = 10000
```

For a complete example, try the file `ec/app/ecsuite/hc.params`

4.3.2 Steepest Ascent Hill-Climbing and $(1 + \lambda)$

Steepest Ascent Hill-Climbing is similar to Simple Hill-Climbing, except that some λ children are generated at one time; they're then whittled down to 1 again (or more specifically, only the best is selected from them). We can do it this way:

1. Build a subpopulation of size 1
2. Loop g times:
 - (a) Test all individuals in the subpopulation
 - (b) Create the next subpopulation, of size $1 + \lambda$
 - (c) Select the best individual in the old subpopulation, and add to the next subpopulation
 - (d) Fill the remaining λ slots with individuals copied and mutated from the best individual

The Evolution Strategies method $(1 + \lambda)$ is the same, with the caveat that the mutation is global: it must in theory be able to produce any child from any parent.

Note again that this method (1) starts with a subpopulation of size 1 but changes it to $1 + \lambda$ later (2) has elitism and (3) breeds children only from the elitist individual. We will do these things as follows. First, we handle the change of subpopulation size:

```
pop.subpop.0.size = 1
# let's say lambda is 10
breed.expanded-subpop-size.0 = 11
```

Next we add elitism:

```
breed.elite.0 = true
```

Finally, to grab the best individual from the previous subpopulation efficiently, we use `ec.select.TopSelection`, for example, something like:

```
pop.subpop.0.species.pipe = ec.vector.breed.VectorMutationPipeline
pop.subpop.0.species.pipe.source.0 = ec.select.TopSelection
```

Because our population is 10x larger than our simple hillclimbing example, we'll run for 1/10 the generations, and adjust the modulus accordingly:

```
generations = 10000
checkpoint-modulo = 1000
stats-modulo = 1000
exchange-modulo = 1000
```

For a complete example, try the file `ec/app/ecsuite/hcsteep.params`

4.3.3 Steepest Ascent Hill-Climbing With Replacement and $(1, \lambda)$

Steepest Ascent Hill-Climbing With Replacement is similar to Simple Hill-Climbing, except that there is no elitism: the parent is not propagated forward into the next generation, so there are only λ children in the next subpopulation. We can do it like this:

1. Build a subpopulation of size 1
2. Loop g times:
 - (a) Test all individuals in the subpopulation
 - (b) Create the next subpopulation, of size λ
 - (c) Fill the λ slots with individuals copied and mutated from the best individual in the old population

The Evolution Strategies method $(1, \lambda)$ is the same, with the caveat that the mutation is global: it must in theory be able to produce any child from any parent.

Note that this method (1) starts with a subpopulation of size 1 but changes it to λ later (2) does *not* have elitism and (3) breeds children only from the best individual. We will do these things as follows. First, we handle the change of subpopulation size:

```
pop.subpop.0.size = 1
# let's say lambda is 10
breed.expanded-subpop-size.0 = 10
```

No elitism:

```
breed.elite.0 = false
```

Finally, to grab the best individual from the previous subpopulation efficiently, we use `ec.select.TopSelection`, for example, something like:

```
pop.subpop.0.species.pipe = ec.vector.breed.VectorMutationPipeline
pop.subpop.0.species.pipe.source.0 = ec.select.TopSelection
```

Because our population is 10x larger than our simple hillclimbing example, we'll run for 1/10 the generations, and adjust the modulus accordingly:

```

generations = 10000
checkpoint-modulo = 1000
stats-modulo = 1000
exchange-modulo = 1000

```

For a complete example, try the file `ec/app/ecsuite/hcsteepwr.params`

4.3.4 Simulated Annealing

Simulated Annealing is a bit tricky for ECJ because Simulated Annealing is *sometimes* doing elitism on the *best* individual, and sometimes doing it on some *other* individual. This means we can't use our standard elitism trick but have to handle it through elaborate manipulation of the Breeding Pipelines. Here's the general algorithm we'll be using:

1. Build a subpopulation of size 1
2. Loop g times:
 - (a) Test all individuals in the subpopulation
 - (b) Create the next subpopulation, of size λ (normally 2)
 - (c) We need to choose a *parent*: If there's only one individual in the old subpopulation, it's the parent. Otherwise we select a random individual other than the first individual as a *candidate* and...
 - i. If the candidate is fitter than the first individual, it becomes the parent.
 - ii. Else the candidate is as fit as the first individual, one of them becomes the parent (chosen at random).
 - iii. Else if the candidate is less fit than the first individual, the candidate becomes the parent with probability $P = e^{\frac{Fitness(candidate) - Fitness(the\ first\ individual)}{t}}$
 - iv. Else the first individual becomes the parent.
 - (d) Copy the parent to the first slot of the next subpopulation.
 - (e) Fill the remaining $\lambda - 1$ slots of the next subpopulation with mutated copies of the parent.
 - (f) Decrease t , staying ≥ 0 .

Notice that elitism is on the "parent", and the parent can be the best individual or it can be some other individual, so we'll handle this through special Breeding Pipelines as follows. We select the parent using `ec.select.AnnealedSelection`. We'll turn its caching on so it always returns the same parent in a given generation. This parent is passed through `ec.vector.breed.VectorMutationPipeline` to make mutated children, and both are *also* hooked up to a `ec.breed.FirstCopyPipeline`. The `FirstCopyPipeline` will start by reproducing directly from the `AnnealedSelection` for the first individual, then calling the `VectorMutationPipeline` to fill out the remaining individuals.

To pull this off, we need `AnnealedSelection` to serve as a source both to `FirstCopyPipeline` *and* to `VectorMutationPipeline`. This is done using **stubs** (so the top-level pipeline is an `ec.breed.StubPipeline`).

We begin with the population sizes:

```

pop.subpop.0.size = 1
# Lambda is 2 here breed.expanded-subpop-size.0 = 2

```

No elitism, basic checkpoint mechanisms

```

breed.elite.0 = false
checkpoint-modulo = 10000
stats-modulo = 10000
exchange-modulo = 10000

```

Now we define the pipeline structure:

```
pop.subpop.0.species.pipe = ec.breed.StubPipeline
pop.subpop.0.species.pipe.stub-source = ec.select.AnnealedSelection
pop.subpop.0.species.pipe.source.0 = ec.breed.FirstCopyPipeline
pop.subpop.0.species.pipe.source.0.source.0 = stub
pop.subpop.0.species.pipe.source.0.source.1 = ec.vector.breed.VectorMutationPipeline
pop.subpop.0.species.pipe.source.0.source.1.source.0 = stub
```

Finally, we define the caching, annealed temperature, and cutdown for the AnnealedSelection:

```
pop.subpop.0.species.pipe.stub-source.cache = true
pop.subpop.0.species.pipe.stub-source.temperature = 3000.0
pop.subpop.0.species.pipe.stub-source.cutdown = 0.995
```

For a complete example, try the file `ec/app/ecsuite/sa.params`

Chapter 5

Representations

5.1 Vector and List Representations (The `ec.vector` Package)

The `ec.vector` package defines one of the most common representations used in evolutionary algorithms: one-dimensional arrays of numbers or objects. In Genetic Algorithms such things have often been referred to as **chromosomes**. ECJ supports Individuals consisting of a single vector of the following types:

Array Type	Individual	Species
boolean	<code>ec.vector.BitVectorIndividual</code>	<code>ec.vector.VectorSpecies</code>
byte	<code>ec.vector.ByteVectorIndividual</code>	<code>ec.vector.IntegerVectorSpecies</code>
short	<code>ec.vector.ShortVectorIndividual</code>	<code>ec.vector.IntegerVectorSpecies</code>
int	<code>ec.vector.IntegerVectorIndividual</code>	<code>ec.vector.IntegerVectorSpecies</code>
long	<code>ec.vector.LongVectorIndividual</code>	<code>ec.vector.IntegerVectorSpecies</code>
float	<code>ec.vector.DoubleVectorIndividual</code>	<code>ec.vector.FloatVectorSpecies</code>
double	<code>ec.vector.DoubleVectorIndividual</code>	<code>ec.vector.FloatVectorSpecies</code>
Subclasses of <code>ec.vector.Gene</code>	<code>ec.vector.GeneVectorIndividual</code>	<code>ec.vector.GeneVectorSpecies</code>

Note that all the integer-type Individuals (byte, short, int, long) share the same species: `ec.vector.IntegerVectorSpecies`. Likewise, all the float-type Individuals (float, double) share `ec.vector.FloatVectorSpecies`. Last, `GeneVectorIndividual` holds an array of subclasses of the abstract class `ec.vector.Gene`, which you can subclass to do or hold any data type. All these Individuals are subclasses of the abstract class `ec.vector.VectorIndividual`; and all Species are subclasses of `ec.vector.VectorSpecies`.

Each of these Individuals has the same crossover operators and support for vector manipulation. They differ in the default initialization and mutation mechanisms available to them: obviously Gaussian mutation makes little sense on integers, for example.

To make matters simple, ECJ has a single set of `BreedingPipelines` for all of these data types. To do this, the `BreedingPipelines` call crossover or mutation functions in the Individuals themselves (or more properly, in their Species). This is different from other representations and results in some breeding parameters (crossover type, mutation probability) being found in the Species and not in the `BreedingPipeline` in question. But as it makes the package much smaller and simpler, so be it.

ECJ does not use generics in this package: each of the data types above has an Individual subclass all its own. The reason for this is straightforward: generics would be *exceptionally* slow. These are arrays of basic data types, and Java's generics would box and unbox them. So no generics it is.

Every vector or list has a single array which holds the genes proper. This array is:

```
public type[] genome;
```

... where *type* is the array type of the Vector (review the table above). You are welcome to read this array as you like, and modify it if you need to (don't replace it or change its length unless you're doing a List, and even then you should use the cover functions discussed in Section 5.1.2).

Many Vector genomes have minimum and maximum acceptable gene values. These values may be defined for the whole genome, for certain sections of it, or on a per-gene basis. For this reason, the easiest way to get this information is with the `minGene()` and `maxGene()` methods defined in the Vector's Species:

ec.vector.IntegerVectorSpecies Methods

```
public long minGene(int gene)
```

Returns the minimum valid gene value for this gene index.

```
public long maxGene(int gene)
```

Returns the maximum valid gene value for this gene index.

```
public boolean inNumericalTypeRange(long geneVal)
```

Returns true if the given gene value is within the numerical type range of the prototypical Individual for this Species. Note that just because the gene value lies within the type range does *not* mean that it's a valid value — you should use `minGene(...)` and `maxGene(...)` to determine this instead.

ec.vector.FloatVectorSpecies Methods

```
public double minGene(int gene)
```

Returns the minimum valid gene value for this gene index.

```
public double maxGene(int gene)
```

Returns the maximum valid gene value for this gene index.

```
public boolean inNumericalTypeRange(double geneVal)
```

Returns true if the given gene value is within the numerical type range of the prototypical Individual for this Species. Note that just because the gene value lies within the type range does *not* mean that it's a valid value — you should use `minGene(...)` and `maxGene(...)` to determine this instead.

5.1.1 Vectors

The default use of this representation is as *fixed-length* vectors which can be crossed over and mutated. The size of the vectors is specified in the Species. For example, to define Individuals of the form of 100 bytes in Subpopulation 0, we might do this:

```
pop.subpop.0.species = ec.vector.IntegerVectorSpecies
pop.subpop.0.species.ind = ec.vector.ByteVectorIndividual
pop.subpop.0.species.genome-size = 100
```

The package `ec.vector.breed` contains `BreedingPipelines` which know how to manipulate all such vectors. Specifically:

- `ec.vector.breed.VectorMutationPipeline` takes a single source and mutates Individuals from that source by calling the `mutate(...)` method on them (discussed later).
- `ec.vector.breed.VectorCrossoverPipeline` takes a two sources and draws one Individuals at a time each from these sources, then crosses them over by calling the `crossover(...)` method on one of them (discussed later).

- `ec.vector.breed.MultipleVectorCrossoverPipeline`, by Beenish Jamil, a former undergraduate at GMU, takes Individuals from a variable number of sources, then performs uniform crossover between all of them. For example, imagine if there were three Individuals, A , B , and C . For each index i , `MultipleVectorCrossoverPipeline` randomly shuffles the values among A_i , B_i , and C_i with a certain `crossoverProbability`, described next.

5.1.1.1 Initialization

VectorIndividuals are initialized by being cloned from the prototypical Individual, and then having the following method called on them:

```
public void reset(EvolutionState state, int thread);
```

You can override this as you see fit, but how VectorIndividuals implement this method by default depends on their type:

- **Boolean**: each gene is set to a random value.
- **Integer** (byte, short, int, long): each gene is set to a random value between its legal minimum and maximum values, inclusive.
- **Floating Point** (float, double): each gene is set to a random value between its legal minimum and maximum values, inclusive. **Note**: in some special cases (which you won't normally see) floating point individuals will have their genes set to integer values only. Section 5.1.1.5 (Heterogeneous Individuals) explains when that can happen.
- **Gene**: each gene is randomized by calling the following method on its `ec.vector.Gene`:

```
public void reset(EvolutionState state, int thread);
```

Floating Point and Integer individuals need minimum and maximum values for their genes. These values can be set in any combination of three ways:

- Global settings for the entire Individual. For example:

```
pop.subpop.0.species.min-gene = -14
pop.subpop.0.species.max-gene = 92
```

- Settings for *segments* along the Individual. The number of segments is:

```
pop.subpop.0.species.num-segments = 4
```

Segments may be either specified by stating the *start indices* of each segment:

```
pop.subpop.0.species.segment-type = start

pop.subpop.0.species.segment.0.start = 0
pop.subpop.0.species.segment.1.start = 15
pop.subpop.0.species.segment.2.start = 50
pop.subpop.0.species.segment.3.start = 80
```

... or they may be specified by stating the *end indices* of each segment.¹

¹Why do this? It's a long story, with no good excuses.

```

pop.subpop.0.species.segment-type = end

pop.subpop.0.species.segment.0.end = 14
pop.subpop.0.species.segment.1.end = 49
pop.subpop.0.species.segment.2.end = 79
pop.subpop.0.species.segment.3.end = 100

```

Then we specify the min and max gene values for all genes in each segment:

```

pop.subpop.0.species.segment.0.min-gene = -14
pop.subpop.0.species.segment.0.max-gene = 92
pop.subpop.0.species.segment.1.min-gene = 0
pop.subpop.0.species.segment.1.max-gene = 100
pop.subpop.0.species.segment.2.min-gene = 0
pop.subpop.0.species.segment.2.max-gene = 50
pop.subpop.0.species.segment.3.min-gene = -0
pop.subpop.0.species.segment.3.max-gene = 1

```

The code for segments was provided by Rafal Kicingier, then a PhD student at GMU.

- Last, settings for *individual genes* may be stated. Not all genes have to be stated this way, just the ones you want. For example:

```

pop.subpop.0.species.min-gene.59 = 2
pop.subpop.0.species.max-gene.59 = 26
pop.subpop.0.species.min-gene.72 = 3
pop.subpop.0.species.max-gene.59 = 19

```

The rule is: individual gene settings override segment settings, which in turn override global settings.

5.1.1.2 Crossover

The class `ec.vector.breed.VectorCrossoverPipeline` works by calling the following method on one of the `Individual`s, passing in the other:

```
public void defaultCrossover(EvolutionState state, int thread, VectorIndividual ind);
```

The two `Individual`s must be of the same type. You could override this method in a custom `VectorIndividual` of some sort to do your own crossover type.

All `VectorIndividual`s have default implementations of this method, which follow parameters specified in their `Species`. The first thing to know about crossover in vectors is that most forms (one-point, two-point, uniform) only occur along **chunk boundaries**. By default chunks are the size of a single gene; but you can make them larger. For example, you could specify that crossover can only occur every seven bytes in our `ByteVectorIndividual`:

```
pop.subpop.0.species.chunk-size = 7
```

Why would you do this? Mostly because you have encoded genes such that groups of seven genes together constitute a unit of some sort which shouldn't be broken up arbitrarily via crossover.

ECJ's `ec.vector.breed.VectorCrossoverPipeline` supports five types of crossover. The crossover type is specified like this:

```
pop.subpop.0.species.crossover-type = one-point
```

The types are:

- `one-point` performs standard One-Point crossover, where we select a value $0 \leq c < l$ (l is the vector length), then swap elements whose indices i are $i < c$. Notice that the top element in the vector is never swapped (which is fine) and that if $c = 0$ then nothing is crossed over.
- `one-point-nonempty` performs standard One-Point crossover as above, but with the restriction that $c \neq 0$, thus the crossover cannot be empty (or a “no-op”). This allows you to control the occurrence of “no-op” crossovers in some other way, such as through an `ec.breed.MultiBreedingPipeline`.
- `two-point` performs standard Two-Point crossover, where we select two values $0 \leq a \leq b < l$ (l is the vector length), then swap elements whose indices i are $a \leq i < b$. Notice that if $a = b$ then nothing is crossed over.
- `two-point-nonempty` performs standard Two-Point crossover as above, but with the restriction that $a \neq b$, thus the crossover cannot be empty (or a “no-op”). This allows you to control the occurrence of “no-op” crossovers in some other way, such as through an `ec.breed.MultiBreedingPipeline`.
- `uniform` performs parameterized Uniform crossover, where every gene is crossed over independently with a certain probability. `ec.vector.breed.MultipleVectorCrossoverPipeline` also uses this probability. The probability is stated like this:

```
pop.subpop.0.species.crossover-prob = 0.25
```

(It doesn't make sense to use a probability over 0.5). It's important to note that the `crossover-probability` parameter is the *per-gene* crossover probability, not the probability that the *entire individual* will be crossed over. For that, see the `likelihood` parameter in Section 3.5.

- `line` performs Line Recombination. The two individuals are treated as points in space. A straight line is drawn through both points, and two children are created along this line. If the individuals are \vec{x} and \vec{y} , we draw two random values α and β , each between $-p$ and $1 + p$ inclusive. Then the two children are defined as $\alpha\vec{x} + (1 - \alpha)\vec{y}$ and $\beta\vec{y} + (1 - \beta)\vec{x}$ respectively. For Integer vector individuals, the values of each index are then rounded to the nearest integer. The most common setting of p is 0.25, which allows children to be somewhat outside the hypercube formed with the parents at corners. To set the value of p , we state:

```
pop.subpop.0.species.line-extension = 0.25
```

Line Recombination cannot be performed on `BitVectorIndividuals` or `GeneVectorIndividuals`. And `LongVectorIndividuals` cannot perform Line Recombination with values outside of $[-2^{53}, 2^{53}]$ (or $[-9007199254740992, 9007199254740992]$). This is because the floating-point math in Line Recombination involves doubles, whose total integer precision is 53 bits (a `long`'s integer precision is 63 bits). ECJ's implementation of Line Recombination is due to William Haddon, a former student at GMU.

- `intermediate` performs Intermediate Recombination. This is very similar to Line Recombination. The two individuals are again treated as points in space. Children are created somewhere in the vicinity of the hypercube formed with the two individuals as corners. If the individuals are \vec{x} and \vec{y} , for *every index* i we draw two independent random values α_i and β_i , each between $-p$ and $1 + p$ inclusive. Then genes at index value i of the two children are defined as $\alpha_i x_i + (1 - \alpha_i) y_i$ and $\beta_i y_i + (1 - \beta_i) x_i$ respectively. For Integer vector individuals, the values of each index are then rounded to the nearest integer. Again, the most common setting of p is 0.25, which allows children to be somewhat outside the hypercube formed with the parents at corners. Again, to set the value of p , we state:

```
pop.subpop.0.species.line-extension = 0.25
```

Intermediate Recombination cannot be performed on `BitVectorIndividuals` or `GeneVectorIndividuals`. And `LongVectorIndividuals` cannot perform Intermediate Recombination with values outside of

$[-2^{53}, 2^{53}]$ (or $[-9007199254740992, 9007199254740992]$). This is because the floating-point math in Intermediate Recombination involves doubles, whose total integer precision is 53 bits (a long's integer precision is 63 bits). ECJ's implementation of Intermediate Recombination is also due to William Haddon.

- `sbx` performs Simulated Binary Crossover. This crossover, by Kalyanmoy Deb, attempts to simulate the effect of binary crossover on doubles and floats as if they were encoded as bits. It relies on the Polynomial Distribution and as such has a parameter called the *crossover distribution index* which specifies the kind of distribution. The standard accepted value for this index is 20 (but it's not the ECJ default: you must set it):

```
pop.subpop.0.species.crossover-distribution-index = 20
```

You can use any integer ≥ 0 . There are probably several different versions of SBX out there. The implementation in ECJ is a faithful reproduction of the one which appears in the NSGA-II C code found here: <http://www.iitk.ac.in/kangal/codes/nsga/nsgaorig.tar>

`VectorCrossoverPipeline` can be set to return both crossed-over children or just one of them. This parameter isn't in the `Species` but is actually in the `Pipeline` proper. Let's say that `VectorCrossoverPipeline` was the root `Pipeline` for Subpopulation 0. To set it to return just one child, you'd say:

```
pop.subpop.0.species.pipe = ec.vector.breed.VectorCrossoverPipeline
pop.subpop.0.species.pipe.toss = true
```

Alternatively you could use the default base:

```
vector.xover.toss = true
```

The default value is false.

Customizing Crossover Assuming you're using `VectorCrossoverPipeline`, crossover is handled by the method `defaultCrossover(...)`:

ec.vector.VectorIndividual Methods

```
public void defaultCrossover(EvolutionState state, int thread, VectorIndividual ind)
    Crosses over this individual with ind, modifying both genomes.
```

Simply override this method to set the genome array as you like.

Integer and floating-point `VectorIndividual` subclasses also have minimum and maximum gene bounds. When you initialize your individual, it's probably wise to keep the gene values inside those bounds. These are accessed via methods found in the `VectorIndividual`'s species. For example, `FloatVectorIndividual` can get the maximum gene bound for gene 5 like this:

```
double val = ((FloatVectorSpecies)species).minGene(5);
```

ec.vector.FloatVectorSpecies Methods

```
public double maxGene(int gene)
    Returns the maximum bound on the given gene's value (inclusive) as stipulated by the user.
```

```
public double minGene(int gene)
    Returns the minimum bound on the given gene's value (inclusive) as stipulated by the user.
```

```
public boolean inNumericalTypeRange(double geneVal)
    Returns whether the given gene value is the numerical type range of the VectorIndividual (or more specifically,
    the VectorSpecies' prototypical VectorIndividual). This range should always be at least as large as the minimum
    and maximum gene bound.
```

ec.vector.IntegerVectorSpecies Methods

```
public long maxGene(int gene)
    Returns the maximum bound on the given gene's value (inclusive) as stipulated by the user.

public long minGene(int gene)
    Returns the minimum bound on the given gene's value (inclusive) as stipulated by the user.

public boolean inNumericalTypeRange(double geneVal)
    Returns whether the given gene value is the numerical type range of the VectorIndividual (or more specifically,
    the VectorSpecies' prototypical VectorIndividual). This range should always be at least as large as the minimum
    and maximum gene bound.
```

5.1.1.3 Multi-Vector Crossover

The class `ec.vector.breed.MultipleVectorCrossoverPipeline` performs uniform crossover among the Individuals in question as described earlier. It ignores the `crossover-type` parameter, but it does respect, and indeed require, the parameter:

```
pop.subpop.0.species.crossover-prob = 0.25
```

This is the probability that a given gene index will be shuffled among the various Individuals. As before, it doesn't make much sense for this to be set to any value over 0.5.

5.1.1.4 Mutation

Similarly, the BreedingPipeline `ec.vector.breed.VectorMutationPipeline` does its work by calling the following method on the Individual in question:

```
public void defaultMutate(EvolutionState state, int thread);
```

You could override this method in a custom `VectorIndividual` of some sort to do your own custom kind of mutation.

Every `VectorIndividual` has a default implementation of this method. Mutation parameters are also specified in the Species of each Individual. At present the default mutation procedures do not respect chunk boundaries, unlike Crossover. However, each gene is only mutated with a certain probability. This probability is defined as:

```
pop.subpop.0.species.mutation-probability = 0.1
```

Additionally, you can specify how many times ECJ should try to guarantee that the mutation performed produces a different gene than the original value:

```
pop.subpop.0.species.duplicate-retries = 5
```

The default value for this is 0, meaning that ECJ doesn't bother checking.

Like min- and max-gene settings (see Section 5.1.1.1), the mutation probability and duplicate retries can be set on a per-segment and/or per-gene basis. Thus if you have specified gene segments, you can do stuff like:

```
# segments...
pop.subpop.0.species.segment.0.mutation-probability = 0.3
pop.subpop.0.species.segment.0.duplicate-retries = 4
pop.subpop.0.species.segment.1.mutation-probability = 1.0
...
# genes...
pop.subpop.0.species.mutation-probability.59 = 0.5
pop.subpop.0.species.mutation-probability.72 = 0.0
pop.subpop.0.species.duplicate-retries.14 = 2
...
```

Per-gene settings override per-segment settings, which override global settings.

Kinds of Mutations Different representations have different kinds of mutations. Specifically:

- **Gene:** the default mutation operator for `ec.vector.GeneVectorIndividual`, with the given mutation probability, calls the following `Gene` method:

```
public void mutate(EvolutionState state, int thread);
```

You are responsible for implementing this method. The default version of the method calls:

```
public void reset(EvolutionState state, int thread);
```

...on the `Gene`.

- **Boolean** (`boolean`): allows bit-flip mutation or uniform gene randomization:

Bit-Flip Mutation This mutation simply flips the bit. To use it, you say

```
pop.subpop.0.species.mutation-type = flip
```

You don't really need to say this: it's the default.

Uniform Mutation This mutation randomizes the bit: it may be reset to its previous value of course. To use it, you say

```
pop.subpop.0.species.mutation-type = reset
```

If you set the `duplicate-retries` to a high value, then this is more or less equivalent to bit-flip mutation:

```
pop.subpop.0.species.mutation-type = reset
pop.subpop.0.species.duplicate-retries = 100000
```

... but of course why bother doing this? It's resetting over and over again until it successfully flips the bit. In actuality the usefulness of uniform mutation for boolean vectors is questionable. It's mostly here to be consistent with the integer and float versions.

Mixtures You can specify the mutation method and on a per-segment and/or per-gene basis. Thus if you have specified gene segments, you can do stuff like:

```
# segments...
pop.subpop.0.species.segment.0.mutation-type = reset
pop.subpop.0.species.segment.1.mutation-type = flip
...
# genes...
pop.subpop.0.species.mutation-type.59 = flip
pop.subpop.0.species.mutation-type.72 = reset
...
```

Per-gene settings override per-segment settings, which override global settings. Again, not sure why you'd do it though.

- **Integer** (byte, short, int, long): allows uniform gene randomization (`reset`) and random walk mutation (`random-walk`).

Uniform Mutation Uniform gene randomization simply sets the gene to a random value between its minimum and maximum legal values. To use it, you say:

```
pop.subpop.0.species.mutation-type = reset
```

Random Walk Mutation Random walk mutation performs a random walk starting at the current gene value. Each step in the random walk it sets a variable n to either 1 or -1 . Then it tries adding n to the current value as long as this does not exceed the minimum and maximum legal values. If the values were exceeded, it instead tries subtracting n from the current value as long as this does not exceed the minimum and maximum values. Then with a probability value of `random-walk-probability` it iterates another step, else it immediately quits the walk. At the end of the walk, the gene is set to the current value, as modified during the walk. You will need to specify this probability along with the mutation type, for example:

```
pop.subpop.0.species.mutation-type = random-walk
# This is the probability that we will continue the random walk;
# hence larger probabilities yield longer walks.
pop.subpop.0.species.random-walk-probability = 0.9
```

You have the option of lifting the bounds entirely and letting Random Walk Mutation freely exceed the min/max gene bounds. If you do this, be certain that the particular problem you're testing works properly with values outside the stated initial bounds. To lift the bounds in this way, you say:

```
pop.subpop.0.species.mutation-bounded = false
```

Once again, this does not affect the use of gene bounds in determining initialization values.

Mixtures Like min- and max-gene settings (see Section 5.1.1.1), the mutation method and associated parameters can be set on a per-segment and/or per-gene basis. Thus if you have specified gene segments, you can do stuff like:

```

# segments...
pop.subpop.0.species.segment.0.mutation-type = reset
pop.subpop.0.species.segment.1.mutation-type = random-walk
pop.subpop.0.species.segment.1.random-walk-probability = 0.7
pop.subpop.0.species.segment.1.mutation-bounded = true
...
# genes...
pop.subpop.0.species.mutation-type.59 = reset
pop.subpop.0.species.mutation-type.72 = random-walk
pop.subpop.0.species.random-walk-probability.72 = 0.34
pop.subpop.0.species.mutation-bounded.72 = false
...

```

Per-gene settings override per-segment settings, which override global settings.

- **Floating Point** (float, double): allows uniform gene randomization (`reset`), Gaussian mutation (`gauss`), or Polynomial mutation (`polynomial`).

Uniform Mutation Uniform gene randomization simply sets the gene to a random value between its minimum and maximum legal values. To use it, you say:

```
pop.subpop.0.species.mutation-type = reset
```

Gaussian Mutation Gaussian mutation adds Gaussian noise to the current value. If the result is outside the bounds of minimum and maximum legal values, another Gaussian noise is tried instead, and so on, until a legal value is found. You will need to specify a standard deviation for the Gaussian random noise and also the number of times ECJ should attempt to apply Gaussian noise within the minimum and maximum bounds before giving up and simply keeping the original value. For example:

```

pop.subpop.0.species.mutation-type = gauss
pop.subpop.0.species.mutation-stdev = 0.1
pop.subpop.0.species.out-of-bounds-retries = 20

```

Note that if `out-of-bounds-retries` is 0, then ECJ behaves specially: it never stops retrying. The default value is 100.

Alternatively you can add Gaussian noise to the current values and simply allow the results to freely exceed the min/max gene bounds. No retries are attempted (and `out-of-bounds-retries` is ignored): noise is simply added and that's it. If you do this, be certain that the particular problem you're testing works properly with values outside the stated initial bounds. To lift the bounds in this way, you say:

```
pop.subpop.0.species.mutation-bounded = false
```

This does not affect the use of gene bounds in determining initialization values. Even if you declare the mutation to be bounded, you'll still need to provide `out-of-bounds-retries` (though it won't be used).

Polynomial Mutation Finally, Polynomial mutation is by Kalyanmoy Deb, and uses a distribution chosen from the Polynomial distribution series rather than a Gaussian distribution. All Polynomial distributions have a min and max value ranging in $[-1, 1]$, and Polynomial mutation adjusts this to reflect the min and max gene ranges. The Polynomial distribution used is defined by the *distribution index* and by far the most common setting (but not the ECJ default) is 20. There are at least four different versions of Polynomial mutation in the literature or various common code.

We have implemented two versions: the **standard** version, which can produce values outside the min/max range,² and an **alternative** version found in the NSGA-II C code among certain other places (<http://www.iitk.ac.in/kangal/codes/nsga/nsgaorig.tar>), which modifies the distribution to always mutate values within the min/max range. Note that we've found the alternative version superior for multiobjective optimization problems. In ECJ, **the alternative version is the default**.

To use the *alternative* version, you'll need to state something like this.

```
pop.subpop.0.species.mutation-type = polynomial
pop.subpop.0.species.mutation-distribution-index = 20
pop.subpop.0.species.alternative-polynomial-version = true
pop.subpop.0.species.out-of-bounds-retries = 20
```

You can use any integer ≥ 0 for the distribution index. Note that even though the alternative version doesn't actually need `out-of-bounds-retries`, ECJ requires it anyway, so just put something arbitrary there.

To use the *standard* version, you'll need to state something along these lines.

```
pop.subpop.0.species.mutation-type = polynomial
pop.subpop.0.species.mutation-distribution-index = 20
pop.subpop.0.species.alternative-polynomial-version = false
pop.subpop.0.species.out-of-bounds-retries = 20
```

Here you'll need to provide a rational value for `out-of-bounds-retries`.

Just as was the case for Gaussian noise, you have the option of lifting the bounds entirely and letting Polynomial Mutation freely exceed the min/max gene bounds. In this case, no retries are attempted (and `out-of-bounds-retries` is ignored): noise is simply added and that's it. Again, if you do this, be certain that the particular problem you're testing works properly with values outside the stated initial bounds. To lift the bounds in this way, you say:

```
pop.subpop.0.species.mutation-bounded = false
```

Once again, this does not affect the use of gene bounds in determining initialization values. And even if you declare the mutation to be bounded, you'll still need to provide `out-of-bounds-retries` (though it won't be used).

Mixtures Like min- and max-gene settings (see Section 5.1.1.1), the mutation method and associated parameters can be set on a per-segment and/or per-gene basis, except for `out-of-bounds-retries`, which is global only. Thus if you have specified gene segments, you can do stuff like:

²If you have bounded the mutation, don't worry. If it goes outside the min/max range, we'll just keep trying again and again until we get a valid mutation within the values, up to `out-of-bounds-retries` times. If we've still failed after that, the original gene value is retained.

```

# segments...
pop.subpop.0.species.segment.0.mutation-type = gauss
pop.subpop.0.species.segment.0.mutation-stddev = 0.2
pop.subpop.0.species.segment.0.bounded = true
pop.subpop.0.species.segment.1.mutation-type = polynomial
pop.subpop.0.species.segment.1.bounded = false
pop.subpop.0.species.segment.1.mutation-distribution-index = 10
pop.subpop.0.species.segment.1.alternative-polynomial-version = false
...
# genes...
pop.subpop.0.species.mutation-type.59 = reset
pop.subpop.0.species.mutation-type.72 = gauss
pop.subpop.0.mutation-stddev.72 = 0.0012
pop.subpop.0.bounded.72 = true
...

```

Per-gene settings override per-segment settings, which override global settings.

Numeric representations (integer, floating-point) provide two utility methods which may be useful to you in creating or debugging a custom mutator:

```

public boolean isInRange();
public void clamp();

```

The first method returns true if all the genes in the representation are within their minimum and maximum per-gene bounds. The second method insures that this is the case: if a gene is larger than its maximum, it is set to the maximum; and if it is smaller than the minimum, it is set to the minimum.

Example In the Genetic Algorithms section (Section 4.1.1), we provided an example for a pipeline for crossing over and mutating VectorIndividuals:

```

pop.subpop.0.species.pipe = ec.vector.breed.VectorMutationPipeline
pop.subpop.0.species.pipe.source.0 = ec.vector.breed.VectorCrossoverPipeline
pop.subpop.0.species.pipe.source.0.source.0 = ec.select.TournamentSelection
pop.subpop.0.species.pipe.source.0.source.1 = same
select.tournament.size = 2

```

The example used IntegerVectorIndividuals. Let's change it to DoubleVectorIndividuals, and also specify some constraints.

```

pop.subpops.0.species = ec.vector.FloatVectorSpecies
pop.subpop.0.species.ind = ec.vector.DoubleVectorIndividual
pop.subpop.0.species.genome-size = 100

```

Let's also add some minimum and maximum gene information, both globally and for the first gene:

```

pop.subpops.0.species.min-gene = 0.0
pop.subpops.0.species.max-gene = 1.0
pop.subpops.0.species.min-gene.0 = 0.0
pop.subpops.0.species.max-gene.0 = 2.0

```

We'll do gaussian mutation with 100% likelihood, and some uniform crossover:

```

pop.subpop.0.species.crossover-type = uniform
pop.subpop.0.species.crossover-prob = 0.25
pop.subpop.0.species.mutation-prob = 1.0
pop.subpop.0.species.mutation-type = gauss
pop.subpop.0.species.mutation-stdev = 0.1

```

Another Example Bit vectors used to be very common. Let's change our Individual to one. Note that it uses `ec.vector.VectorSpecies` as its Species:

```

pop.subpops.0.species = ec.vector.VectorSpecies
pop.subpop.0.species.ind = ec.vector.BooleanVectorIndividual
pop.subpop.0.species.genome-size = 128

```

Perhaps our encoding uses each 32 bits to represent some important concept, so we'd like to prevent crossover from occurring anywhere except on 32-bit boundaries:

```

pop.subpops.0.species.chunk-size = 32

```

Booleans only have one mutation parameter: probability of bit-flip. Let's also include two-point crossover on the chunk boundaries:

```

pop.subpop.0.species.crossover-type = one
pop.subpop.0.species.mutation-prob = 0.01

```

5.1.1.5 Heterogeneous Vector Individuals

One common need is individuals which are a mixture of different data types. Of course, since you have `Gene` and `GeneVectorIndividual` and `GeneVectorSpecies` available to you, you can do whatever crazy individuals you like. More on that in Section 5.1.3. But it's more common to need individuals which are a mixture of floating-point, integer, and perhaps boolean genes.

ECJ handles this with two extensions to its `DoubleVectorIndividual` and `FloatVectorIndividual` classes and their associated species `FloatVectorSpecies`. Specifically: these representations can restrict certain individual genes to just integer values, and mutate them like integers rather than floats. This is done by including two additional mutation methods:

- **Uniform Mutation Restricted to Integer Values** This simply sets the gene to a random integer value between its minimum and maximum legal values. For obvious reasons, this will nearly always be done on a per-gene or per-segment basis:

```

# segments...
pop.subpop.0.species.segment.0.mutation-type = reset
pop.subpop.0.species.segment.4.mutation-type = reset
...
# genes...
pop.subpop.0.species.mutation-type.59 = reset
pop.subpop.0.species.mutation-type.72 = reset
...

```

But if you want the default to be integer uniform mutation, you can do that.

```

pop.subpop.0.species.mutation-type = integer-reset

```

Remember that per-gene values override per-segment settings which in turn override global settings.

You should take care to make sure that the min-gene and max-gene values are integers. **Use of this mutation method will also change how initialization is done: this gene will be initialized to only an integer value.**

- **Random Walk Mutation** This method works just like Random Walk Mutation for integers, and has similar parameters. It only does random walks through integer values in the floating point space. Again, for obvious reasons, this will nearly always be done on a per-gene or per-segment basis:

```
# segments...
pop.subpop.0.species.segment.2.mutation-type = integer-random-walk
pop.subpop.0.species.segment.2.random-walk-probability = 0.9
pop.subpop.0.species.segment.2.bounded = true
pop.subpop.0.species.segment.9.mutation-type = integer-random-walk
pop.subpop.0.species.segment.9.random-walk-probability = 0.7
pop.subpop.0.species.segment.9.bounded = false
...
# genes...
pop.subpop.0.species.mutation-type.41 = integer-random-walk
pop.subpop.0.random-walk-probability.42 = 0.9
pop.subpop.0.random-walk-probability.bounded.42 = false
pop.subpop.0.species.mutation-type.22 = integer-random-walk
pop.subpop.0.random-walk-probability.22 = 0.95
pop.subpop.0.random-walk-probability.bounded.22 = true
...
```

But if you want the default to be integer random mutation, you can do that.

```
pop.subpop.0.species.mutation-type = integer-random-walk
pop.subpop.0.species.random-walk-probability = 0.9
```

Remember that per-gene values override per-segment settings which in turn override global settings. Again, you should take care to make sure that the min-gene and max-gene values are integers. **Use of this mutation method will also change how initialization is done: this gene will be initialized to only an integer value.**

What You Can Do Using the above mutation methods and their associated automatic initialization procedures, you can create genes which are:

- **Floats** Just mutate the gene using a normal floating-point mutation method.
- **Integers** Specify one of the two above integer mutation methods and appropriate parameters if not specified as defaults. Specify a min-gene and max-gene which are integer values. In your Problem, interpret this gene value (which will always be an integer) as an integer.
- **Members of a Fixed Size Set** Let's say the set holds n elements. Specify min-gene to be 0 and max-gene to be $n - 1$. Choose integer uniform (reset) mutation. In your Problem, interpret this gene value (which will always be an integer) as a particular set element.
- **Booleans** This is just like Members of a Fixed Size Set, except that $n = 2$. In your Problem, interpret a gene value of 0.0 as false and a gene value of 1.0 as true.

If you need more complex mixtures (vectors of trees and sets and graphs and Strings, or whatever), you'll need to use GeneVectorIndividual and customize it as you see fit.

5.1.2 Lists

While vectors are arrays of fixed length, Lists are arrays of arbitrary and possibly changing length. List representations are much less common in evolutionary algorithms. Since they are of arbitrary length, **you should not use per-gene or per-segment parameter specification with lists**. It's global parameters or nothing.

With a few changes, the classes in ECJ's `ec.vector` package may be used for lists as well as for vectors. ECJ supports list representations in four ways:

- Useful utility methods for manipulating lists.
- List-oriented initialization
- List-oriented crossover procedures. Default vector crossover also can work for lists.
- List-oriented mutation procedures. Default vector mutation also works fine for lists.

Let's cover each in turn. But first read the previous section on Vectors (Section 5.1.1). And note that lists completely ignore the chunk facility: it's too complex.

5.1.2.1 Utility Methods

`VectorIndividual` provides methods for manipulating the genome without knowing the type of the object in question. First, the genome (the array) may be retrieved and set:

```
public Object getGenome();
public void setGenome(Object genome);
```

Second, the genome length can be changed. If the length is shortened, the array will be truncated. If the length is lengthened, the extra area will be set as follows: boolean array slots will be set to false. Numeric array slots will be set to 0. Gene array slots will be set to a blank Gene cloned from the prototype. The methods for checking or changing the length are:

```
public int size();
public int genomeLength();
public void setGenomeLength(int length);
public void reset(EvolutionState state, int thread, int newSize);
```

The first two methods are synonymous. The last method resizes the individual, then resets it entirely (randomizes its values).

Third, `VectorIndividual` supplies methods for cutting a splicing genome arrays, which is quite useful for manipulating variable-length lists. For example, you can **split** a genome into some n pieces. To do this you provide $n - 1$ split points. The first piece will start at index 0 and run up to, but not including, the first split point; the second piece will start with the first split point and run up to, but not including, the second split point; and so on. The final piece will run to the end of the genome. The n pieces are placed into the provided Object array.

```
public void split(int[] points, Object[] pieces);
```

Note that each of the pieces is an array of the proper type. For example, in `DoubleVectorIndividual`, each piece is a `double[]`.

`VectorIndividual` can also **join** certain pieces — concatenate them — to form the genome, replacing the original genome.

```
public void join(Object[] pieces);
```

Last, `VectorIndividual` can clone all the genes in a given piece, setting that piece to the cloned values. This is useful for concatenating genes to an `Individual` for example. Obviously, genomes consisting of arrays of numbers or booleans don't need to be "cloned" — but the `Genes` found in `GeneVectorIndividual` need to be copied or else the concatenated gene slots will share pointers with the original genes, which you perhaps didn't want. Note that the `pieces` array is modified in place.

```
public void cloneGenes(Object piece);
```

5.1.2.2 Initialization

The initial size of the genome can be hard-coded in parameters (just like it was for vectors), or you can specify one of two algorithms for picking a size. To hard-code the size, just do it like a vector:

```
pop.subpop.0.species.genome-size = 100
```

Alternatively you can ask ECJ to pick the genome size uniformly from between a minimum and maximum size inclusive:

```
pop.subpop.0.species.genome-size = uniform
pop.subpop.0.species.min-initial-size = 10
pop.subpop.0.species.max-initial-size = 80
```

Last, you can ask ECJ to pick the genome size from the geometric distribution. Here ECJ will start at the minimum size, then flip a coin of a given probability. If the coin comes up heads (true), ECJ will increase the size by one, then flip the coin again, and so on, until the coin comes up tails (false). That'll be the resulting size. For this you need to provide the probability and the minimum size:

```
pop.subpop.0.species.genome-size = geometric
pop.subpop.0.species.min-initial-size = 10
pop.subpop.0.species.geometric-prob = 0.95
```

5.1.2.3 Crossover

The standard vector crossover procedures will work fine for lists: but they will only perform crossover in the first n indices of the lists, where n is the minimum length of either list. For example, one-point crossover will pick a crossover point $p < n$, then swap elements 0 through $p - 1$, leaving the rest of the lists alone. Additionally, a warning will be issued letting you know when this happens.

There are more options. In the `ec.vector.breed` package is one special pipeline made for crossing over lists, called, not surprisingly, `ec.vector.breed.ListCrossoverPipeline`. This class was developed by Stephen Donnelly, then an undergraduate at GMU.

`ListCrossoverPipeline` performs either one-point or two-point list crossover. In one-point list crossover, we pick random indexes i and j in each of two individuals A and B (which may have different lengths). We then swap the string of genes A_i, \dots, A_{end} and B_j, \dots, B_{end} . It's possible for these strings to be all of the `Individual`, or entirely empty.

In two-point list crossover, for each individual we pick *two* random indexes: $i \leq j$ for `Individual A` and $k \leq l$ for `Individual B`. We then swap the string of genes A_i, \dots, A_j with B_k, \dots, B_l . Again, it's possible for these strings to be all of the `Individual`, or entirely empty.

You specify the form of crossover like you do with `Vectors`: in the `Species`.

```
pop.subpop.0.species.crossover-type = one-point
```

(or two-point, if you prefer).

ListCrossoverPipeline's crossover can be constrained in several ways. First, you can stipulate that the children are no less than a certain size. Let's say that ListCrossoverPipeline was the root Pipeline for Subpopulation 0. To set it to never return children less than 5 in length, you might say:

```
pop.subpop.0.species.pipe = ec.vector.breed.ListCrossoverPipeline
pop.subpop.0.species.pipe.min-child-size = 5
```

The default is 0.

To set it to never remove more than a certain percentage, and no less than another percentage, of material from a parent, you could say:

```
pop.subpop.0.species.pipe.min-crossover-percent = 0.25
pop.subpop.0.species.pipe.max-crossover-percent = 0.50
```

The defaults are 0.0 and 1.0 respectively.

ListCrossoverPipeline will try repeatedly to find crossover points which met these constraints. If it fails, it will simply return the two parents. You set the number of times it will try like this:

```
pop.subpop.0.species.pipe.tries = 100
```

The default is 1.

Like VectorCrossoverPipeline, ListCrossoverPipeline can be set to return both crossed-over children or just one of them. To set it to return just one child, you'd say:

```
pop.subpop.0.species.pipe.toss = true
```

The default value is false.

Alternatively you could use the default base for any or all of these:

```
vector.list-xover.min-child-size = 5
vector.list-xover.min-crossover-percent = 0.25
vector.list-xover.max-crossover-percent = 0.50
vector.list-xover.tries = 100
vector.list-xover.toss = true
```

5.1.2.4 Mutation

The standard vector mutation operator will work fine in list mode: it doesn't care what the length of the array is.

ECJ at present has a single mutation operator special to lists: `ec.vector.breed.GeneDuplicationPipeline`. This pipeline replicates a particular mutation operation common in Grammatical Evolution (Section 5.3). Specifically: we select two indices in the list at random such that they are not equal to one another. Then we copy the region between the two indices, and concatenate it to the end of the list. And that's it!

Example Let's modify the Vector example given previously. First, we'll change the crossover procedure:

```
pop.subpop.0.species.pipe = ec.vector.VectorMutationPipeline
pop.subpop.0.species.pipe.source.0 = ec.vector.ListCrossoverPipeline
pop.subpop.0.species.pipe.source.0.source.0 = ec.select.TournamentSelection
pop.subpop.0.species.pipe.source.0.source.1 = same
select.tournament.size = 2
```

Let's stipulate that crossed-over individuals must be at least two genes in length if possible:

```
pop.subpop.0.species.pipe.source.0.min-child-size = 2
```

Finally, let's change the procedure for determining the initial size of an Individual:

```
pop.subpop.0.species.genome-size = geometric
pop.subpop.0.species.min-initial-size = 10
pop.subpop.0.species.geometric-prob = 0.95
```

5.1.3 Arbitrary Genes: `ec.vector.Gene`

Last, some discussion should be reserved regarding vectors of “arbitrary genes”. The idea behind this is to provide you with maximum flexibility as to what you can create vectors out of. Before we start, note that if your goal is just to do some heterogeneity within the standard classes (a vector consisting of a boolean, an int, and ten floats, say) you'd be better off with ECJ's heterogeneous gene facility (see Section 5.1.1.5), which will require much less coding. But if you need something *completely arbitrary*, such as vectors of trees or vectors of finite-state automata, you've come to the right place.

So. The classes involved here are:

- `ec.vector.Gene`, the abstract superclass of objects which can fill gene positions.
- `ec.vector.GeneVectorIndividual`, the `VectorIndividual` which contains nothing but Genes.
- `ec.vector.GeneVectorSpecies`, the `Species` for `GeneVectorIndividuals`.

To use these classes, you'll not only need to specify the use of `GeneVectorIndividual` and `GeneVectorSpecies`, but you'll also need to state which subclass of `Gene` will be used to fill the `GeneVectorIndividual`. These three things are done as follows:

```
pop.subpop.0.species = ec.vector.GeneVectorSpecies
pop.subpop.0.species.ind = ec.vector.GeneVectorIndividual
pop.subpop.0.species.gene = ec.app.MySubclassOfGene
```

As mentioned earlier, `GeneVectorIndividual`'s `reset(...)` method, used to initialize the `Individual`, in turn calls this method on your `Gene` subclass:

```
public abstract void reset(EvolutionState state, int thread);
```

Furthermore, mutation on `GeneVectorIndividuals` call this method on each `Gene` (with the mutation probability):

```
public abstract void mutate(EvolutionState state, int thread);
```

The default form of this method just calls `reset(...)`. You'd probably want to make a better mutation function than this.

`Gene` is a `Prototype`, and so requires `setup(...)`, `clone(...)`, and `defaultBase()`. Default implementations are already provided for you. Except for `clone(...)` you're unlikely to need to override them.

You do need to provide two additional `Gene` methods:

```
public abstract int hashCode();
public abstract boolean equals(Object other);
```

The first method should provide an intelligent hash code based on the value of the `Gene` contents. The second method should test this `Gene` against another for equality and return true if they contain the same thing.

Technically that's all you need to provide. But in reality Gene is not going to be very useful unless you at least provide a way to describe the gene when it's printed to a log. The easiest way to do this is to override this method:

```
public String printGeneToStringForHumans();
```

The default version of this method simply calls toString() (which you could override too if you wanted). This method is in turn called by

```
public void printGeneForHumans(EvolutionState state, int verbosity, int log);
```

If you're writing Individuals with the intent that they be read back in again later, you'll probably want to override this method:

```
public String printGeneToString();
```

This method is called in turn by the following two methods:

```
public void printGene(EvolutionState state, int verbosity, int log);
public void printGene(EvolutionState state, PrintWriter writer);
```

The default form simply calls toString(), which is definitely wrong. You'll also want to override the method which reads in the gene again:

```
public void readGeneFromString(String string, EvolutionState state);
```

To write out the gene in a computer-readable fashion, I suggest using ECJ's Code package (Section 2.2.3), but it's up to you. This method is called by

```
public void readGene(EvolutionState state, LineNumberReader reader) throws IOException;
```

Finally if you're intending to send your Individual over the network, either for distributed evaluation or island models, you'll need to implement these methods:

```
public void writeGene(EvolutionState state, DataOutput output) throws IOException;
public void readGene(EvolutionState state, DataInput input) throws IOException;
```

Example The following Gene contains two doubles and mutates them by performing a random affine rotation on them (why not?). We'll implement it fully here, though keep in mind that this isn't entirely necessary. For fun, we'll use an elaborate hash code which XORs all four 32-bit segments of the two doubles together (I hope I wrote that right!).

First the parameters:

```
pop.subpop.0.species = ec.vector.GeneVectorSpecies
pop.subpop.0.species.ind = ec.vector.GeneVectorIndividual
pop.subpop.0.species.gene = ec.app.trig.TrigGene
```

Now the implementation:

```

package ec.app.trig;
import ec.util.*;
public class TrigGene extends Gene {
    double x;
    double y;
    public void reset(EvolutionState state, int thread) {
        double alpha = state.random[thread].nextDouble() * Math.PI * 2;
        x = Math.cos(alpha);    y = Math.sin(alpha);
    }

    public void mutate(EvolutionState state, int thread) {
        double alpha = Math.atan2(y,x);
        double dalpha = (state.random[thread].nextDouble() - 0.5) * Math.PI * 2 / 100.0;
        x = Math.cos(alpha + dalpha);    y = Math.sin(alpha + dalpha);
    }

    public int hashCode() {
        long a = Double.doubleToRawLongBits(x);    long b = Double.doubleToRawLongBits(y);
        return (int) ((a & (int)-1) ^ (a >> 32) (b & (int)-1) ^ (b >> 32));
    }

    public boolean equals(Object other) {
        return (other != null && other instanceof TrigGene &&
            ((TrigGene)other).x == x && ((TrigGene)other).y == y);
    }

    public String printGeneToStringForHumans() { return ">" + x + " " + y ; }

    public String printGeneToString() {
        return ">" + Code.Encode(x) + " " + Code.Encode(x);
    }

    public void readGeneFromString(String string, EvolutionState state) {
        string = string.trim().substring(0); // get rid of the ">"
        DecodeReturn dr = new DecodeReturn(string);
        Code.decode(dr);    x = dr.d;           // no error checking
        Code.decode(dr);    y = dr.d;
    }

    public void writeGene(EvolutionState state, DataOutput out) throws IOException {
        out.writeDouble(x);    out.writeDouble(y);
    }

    public void readGene(EvolutionState state, DataOutput in) throws IOException {
        x = in.readDouble();    y = in.readDouble();
    }
}

```

5.2 Genetic Programming (The ec.gp Package)

The ec.gp package is far and away the most developed and tested package in ECJ. ECJ was largely developed in order to support this package, and much of our existing literature is based on it.

ECJ's genetic programming package uses "Koza-style" tree structures [6, 7] which represent the parse trees of Lisp s-expressions. For an introduction to genetic programming, see [19]. Much of ECJ's approach

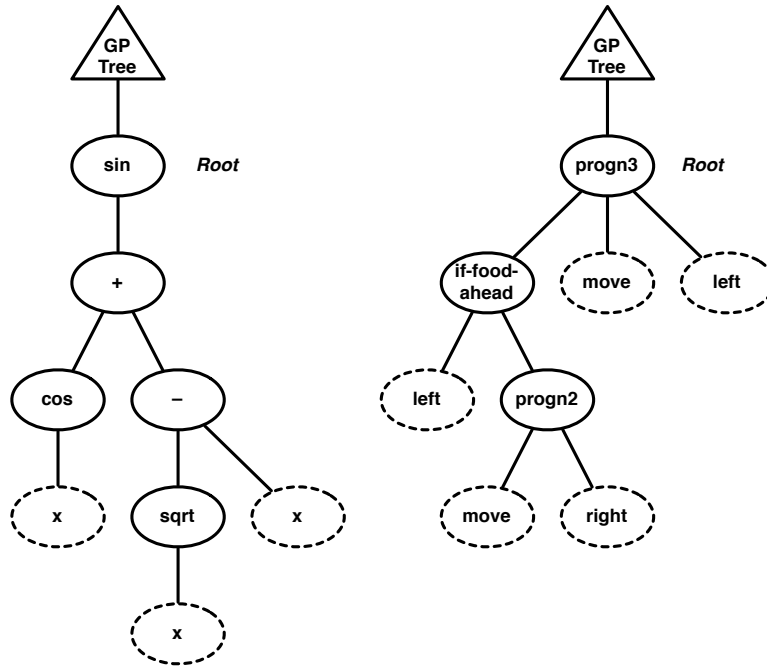

Figure 5.2 Two example genetic programming parse trees. At top is a single `ec.gp.GPTree` instance, which holds onto a single `ec.gp.GPNode` designated the *root* of the tree. `GPNodes` form the tree itself, and so have a *parent* and zero or more *children*. The parent of the root is the `GPTree` object itself. Leaf nodes, denoted with dotted ovals, are traditionally called *terminals*, and non-leaf nodes, including the root, are traditionally called *nonterminals*. Normally `GPNodes` have fixed arity. That is, all `if-food-ahead` `GPNodes` will always have two children, and all `cos` nodes will always have one child, etc.

to GP is inspired by *lil-gp* [21], an earlier C-based GP system. However *lil-gp* and many other GP systems pack the parse trees into arrays to save memory. ECJ does not: the parse trees are stored as tree structures in memory. This is much more wasteful of memory but it is faster to evaluate and far easier to manipulate.

GP's top-level class is an `Individual` called `ec.gp.GPIndividual`. `GPIndividual` holds an array of GP trees, held by `ec.gp.GPTree` objects. Each GP tree is a tree of `ec.gp.GPNode` objects. One `GPNode`, the root of the tree, is held by the `GPTree`.

`GPIndividual`, `GPTree`, and `GPNode` are all `Prototypes`, and furthermore they all adhere to the *flyweight* pattern (Section 3.1.4). `GPIndividual`'s flyweight relationship is with a `Species` (of course), called `ec.gp.GPSpecies`. `GPTrees` have a flyweight relationship with subclasses of `ec.gp.GPTreeConstraints`. `GPNodes` have a flyweight relationship with subclasses of `ec.gp.GPNodeConstraints`.

GP's tree nodes are **typed**, meaning that they can have certain constraints which specify which nodes may serve as children of other nodes. These types are defined by an abstract class called `ec.gp.GPType`, of which there are two concrete subclasses, `ec.gp.GPAtomicType` and `ec.gp.GPSetType`.

The primary function of `GPSpecies` is to build new `GPIndividuals` properly. The primary function of `GPTreeConstraints` is to hold onto the **function set** (`ec.gp.GPFunctionSet`) for a given tree. This is a set of prototypical `GPNodes`, copies of which are used to construct the tree in question. `GPTreeConstraints` also contains typing information for the tree root. The primary purpose of `GPNodeConstraints` is to provide typing and arity information for various `GPNode`.

5.2.1 GPNodes, GPTrees, and GPIndividuals

Figure 5.2 shows two example trees of `GPNodes` (shown as ovals). The top of each tree is a `GPTree`, and directly under it is the *root* `GPNode`. As can be seen from the figure, each `GPNode` has both a parent and

zero or more children; and each GPTree has exactly one child. Both GPNodes and GPTrees implement `ec.gp.GPNodeParent`, and can serve as parents of other GPNodes (the root has the GPTree as its parent).

5.2.1.1 GPNodes

A basic GPNode consists of four items:

```
public GPNodeParent parent;
public GPNode children[];
public byte argposition;
public byte constraints;
```

The parent should be self-explanatory. The `children[]` is an array holding the children to the GPNode. Leaf nodes in a GP tree (traditionally called **terminals**) are permitted to either have a zero-length array or a null value for `children[]`.

The `argposition` is the position of the node in its *parent's* `children[]` array. The root's `argposition` is 0. Last, the `constraints` is a tag which refers to the GPNode's `GPNodeConstraints` object. It's a byte rather than a full pointer to save a bit of space: GPNodes make up by far the bulk of memory in a genetic programming experiment. You can get the `GPNodeConstraints` by calling the following GPNode method:

```
public final GPNodeConstraints constraints(GPInitializer initializer);
```

Why the `GPInitializer`? Because `GPNodeConstraints`, `GPTreeConstraints`, `GPTypes`, and `GPFunctionSets` are all accessible via the `Initializer`, which must be a `GPInitializer`.³ More on that later. Assuming you have access to the `EvolutionState` (probably called `state`) can call this function like this:

```
GPNodeConstraints constraints = myGPNode.constraints((GPInitializer)(state.initializer));
```

You will make various subclasses of `GPNode` to define the kinds of functions which may appear in your genetic programming tree.

5.2.1.2 GPTrees

Unlike `GPNode`, which is liberally subclassed, you'll rarely subclass `GPTree`. The `ec.gp.GPTree` class holds onto the root `GPNode` here:

```
public GPNode child;
```

Each `GPTree` also has a backpointer to the `GPIndividual` which holds it:

```
public GPIndividual owner;
```

`GPTree` also has a pointer to its `GPTreeConstraints` object. Like `GPNode`, `GPTree` uses a byte rather than a full pointer.⁴

```
public byte constraints;
```

Just like `GPNode`, you can access `GPTree's` constraints using this function:

```
public final GPTreeConstraints constraints(GPInitializer initializer);
```

...which is typically called like this:

³It wasn't a good decision to use the `Initializer` in this fashion, and one day we may change it to something else.

⁴This is mostly historic: `GPTree` doesn't fill nearly as much memory as `GPNode` and so doesn't really need this tight reference approach.

```
GPTreeConstraints constraints = myGPTree.constraints((GPInitializer)(state.initializer));
```

5.2.1.3 GPIndividual

The GPIndividual contains an array of GPTrees. In most cases, this array has a single GPTree in it:

```
public GPTree[] trees;
```

5.2.1.4 GPNodeConstraints

The GPNodeConstraints contains several data elements shared by various GPNodes:

```
public byte constraintNumber;
public GPType returntype;
public GPType[] childtypes;
public String name;
public double probabilityOfSelection;
public GPNode zeroChildren[] = new GPNode[0];
```

The first element is obvious: it's number of the constraints which the GPNode objects point to. The next two items hold the return type and children types of the node: more on that later. Specifically, the return type of a child in slot 0 must be compatible with the child type declared for slot 0. For now what matters is that you can determine the expected number of children to a GPNode by the length of the childtypes array.

The name variable holds the name of the GPNodeConstraints (*not* the GPNodes which refer to them): we'll define some in the next section. The probabilityOfSelection variable holds an auxiliary variable used by certain tree-building operators. Last, zeroChildren[] holds a blank, zero-length GPNode which terminals are free to use in lieu of null for their children.

5.2.1.5 GPTreeConstraints

The GPTreeConstraints contains data elements shared by GPTrees:

```
public byte constraintNumber;
public GPType treetype;
public String name;
public GPNodeBuilder init;
public GPFunctionSet functionset;
```

The first element is again obvious. The treetype variable declares the GPType for the tree as a whole: the return type of the root must be compatible with this type. The name works similarly to the one in GPNodeConstraints.

The last two variables are critical. The init variable holds the algorithm used to generate trees or subtrees for this GPTree. We will discuss tree builders later. Last, the functionset variable holds the function set for this tree: all GPNodes appearing in this GPTree must be cloned from this function set.

5.2.1.6 GPFunctionSet

The GPFunctionSet contains a name (like GPNodeConstraints and GPTreeConstraints) and a set of GPNodes, clones of which may appear in the GPTree. This set is stored in various hash tables and arrays to make lookup easy for different common queries (such as "give me all terminals") or ("give me all nodes whose return type is *foo*"). Usually you don't need to access this class directly: instead, we'll set up the function set using parameters.

5.2.2 Basic Setup

Now let's work towards setting a GP problem. We begin by defining the `GPIndividual` and `GPSpecies`. Usually, we'll just use those classes directly:

```
pop.subpop.0.species = ec.gp.GPSpecies
pop.subpop.0.species.ind = ec.gp.GPIndividual
```

Let's presume for now that we just want a single tree per `GPIndividual`. This is the usual case. Typically this class is defined by `GPTree` unless we're doing something odd. We say:

```
pop.subpop.0.species.ind.numtrees = 1
pop.subpop.0.species.ind.tree.0 = ec.gp.GPTree
```

Different trees can have different `GPTreeConstraints` objects, or share them. This is done by defining a set of `GPTreeConstraints` (which is a `Clique`, Section 3.1.2) and giving each member of the set a unique identifier. Then `GPTrees` identify with a given `GPTreeConstraints` by using that identifier.

Since we have only one tree, we really only need to create one `GPTreeConstraints`. We'll call it "tc0".

```
gp.tc.size = 1
gp.tc.0 = ec.gp.GPTreeConstraints
gp.tc.0.name = tc0
```

Note that as a `Clique`, `GPTreeConstraints` objects all have a global parameter base of `gp.tc`. Now we assign it to the tree:

```
pop.subpop.0.species.ind.tree.0.tc = tc0
```

A `GPTreeConstraints` object in turn holds onto the `GPFunctionSet` used to construct trees which identify with it. `GPFunctionSet` is also a `clique`. We'll call the function set "f0":

```
gp.fs.size = 1
gp.fs.0 = ec.gp.GPFunctionSet
gp.fs.0.name = f0
```

Note that as a `Clique`, `GPFunctionSet` objects all have a global parameter base of `gp.fs`. We now assign this function set to our tree constraints:

```
gp.tc.0.fset = f0
```

As to types: we'll discuss typed GP later on. For now we'll assume that there is a single atomic type which is used universally by everyone — that is, everything can connect with everything (it's "typeless"). This is the classic GP scenario. `GPTypes` are also a `clique`: and they have a global parameter base of `gp.type`. We define zero `GPSetTypes` and one `GPAtomicType` (which we will name, for lack of a better word, "nil") like this:

```
gp.type.a.size = 1
gp.type.a.0.name = nil
gp.type.s.size = 0
```

Our `GPTreeConstraints` object needs to define the `GPType` of the tree as a whole (the "root type"). To set it to our `nil` type, we'd say:

```
gp.tc.0.returns = nil
```

This means that the root `GPNode` of the tree must have its return type compatible with `nil`.

Last, we need to define some `GPNodeConstraints`. A `GPNodeConstraint` object describes three things about the `GPNodes` related to them via the Flyweight pattern:

- The number of children of the `GPNode`.
- The `GPTypes` that the children of the `GPNode` must be consistent with.
- The `GPType` of that the parent of the `GPNode` must be consistent with.

More on types later. But for now we'll define a few `GPNodeConstraints` for nodes with zero, one, and two children. Since we only have one type, the types of all the children and the return type are all going to be `nil`. We'll call these `GPNodeConstraints` `nc0`, `nc1`, and `nc2`.

```
gp.nc.size = 3

gp.nc.0 = ec.gp.GPNodeConstraints
gp.nc.0.name = nc0
gp.nc.0.returns = nil
gp.nc.0.size = 0

gp.nc.1 = ec.gp.GPNodeConstraints
gp.nc.1.name = nc1
gp.nc.1.returns = nil
gp.nc.1.size = 1
gp.nc.1.child.0 = nil

gp.nc.2 = ec.gp.GPNodeConstraints
gp.nc.2.name = nc2
gp.nc.2.returns = nil
gp.nc.2.size = 2
gp.nc.2.child.0 = nil
gp.nc.2.child.1 = nil
```

5.2.2.1 Defining `GPNodes`

Let's imagine that we're trying to create trees that consist of the following tree nodes (which we'll create later): `ec.app.myapp.X`, `ec.app.myapp.Y`, `ec.app.myapp.Mul`, `ec.app.myapp.Sub`, `ec.app.myapp.Sin`. These nodes take 0, 0, 2, 2, and 1 children respectively and have no special types (we'll use `nil`). We could add them to the function set like this:

```
gp.fs.0 = ec.gp.GPFunctionSet
gp.fs.0.size = 5
gp.fs.0.func.0 = ec.app.myapp.X
gp.fs.0.func.0.nc = nc0
gp.fs.0.func.1 = ec.app.myapp.Y
gp.fs.0.func.1.nc = nc0
gp.fs.0.func.2 = ec.app.myapp.Mul
gp.fs.0.func.2.nc = nc2
gp.fs.0.func.3 = ec.app.myapp.Sub
gp.fs.0.func.3.nc = nc2
gp.fs.0.func.4 = ec.app.myapp.Sin
gp.fs.0.func.4.nc = nc1
```

Notice that we don't state the number of children or the types explicitly: instead we state them implicitly by assigning the appropriate `GPNodeConstraints` object.

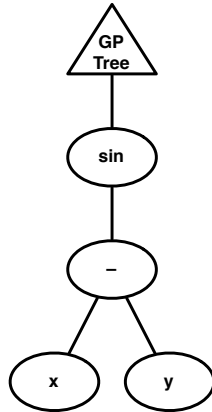

Figure 5.3 A simple GP tree representing the mathematical expression $\sin(x - y)$.

5.2.3 Defining the Representation, Problem, and Statistics

GP is more complex than most other optimization procedures because of its representation. When you create a GP problem, you have two primary tasks:

- Create the GPNodes with which a GPIndividual may be constructed
- Create a Problem which tests the GPIndividual

Let's start with the first one. As an example, we'll build a simple Symbolic Regression example on two variables, X and Y. The GP tree can have GPNodes which subtract, multiply, and perform sine, just as was done earlier.⁵ This means we'll need two terminals (X and Y), and three nonterminals (subtract and multiply, each of arity 2—two children each— and cosine, with arity 1).

Recall from Section 5.2.2 that our function set would look like this:

```

gp.fs.0 = ec.gp.GPFunctionSet
gp.fs.0.size = 5
gp.fs.0.func.0 = ec.app.myapp.X
gp.fs.0.func.0.nc = nc0
gp.fs.0.func.1 = ec.app.myapp.Y
gp.fs.0.func.1.nc = nc0
gp.fs.0.func.2 = ec.app.myapp.Mul
gp.fs.0.func.2.nc = nc2
gp.fs.0.func.3 = ec.app.myapp.Sub
gp.fs.0.func.3.nc = nc2
gp.fs.0.func.4 = ec.app.myapp.Sin
gp.fs.0.func.4.nc = nc1
  
```

We need to make each of these classes. Each of these are GPNodes with a single crucial method overridden:

```

public abstract void eval(EvolutionState state, int thread, GPData input,
                        ADFStack stack, GPIndividual individual, Problem problem);
  
```

This method is called when the GPNode is being executed in the course of executing the tree. Execution proceeds depth-first like the evaluation of a standard parse tree. For example, in order to compute the expression $\sin(x - y)$ (shown in GP form in Figure 5.3) we will call `eval(...)` on the Sin object, which will in

⁵Ridiculously limited, but what did you expect? This is a demonstration example!

turn call `eval(...)` on the `Sub` object. This will then call `eval(...)` on the `X` object, then on the `Y` object. `X` and `Y` will return their values. The `Sub` object will then subtract them and return the result, and finally `Sin` will return the sine of that.

Execution doesn't have to be just in terms of calling `eval(...)` on children, processing the results, and returning a final value. In fact, for some problems the return value may not matter at all, but simply which nodes are executed. In this case, likely the nodes themselves are doing things via side effects: moving a robot around, for example. Execution could also be tentative: an "if" node might evaluate one or another of its children and leave it at that. Execution could also be repetitive: you might make a "while" node which repeatedly evaluates a child until some test is true. Basically you can execute these nodes any way that might appear in a regular programming language.

5.2.3.1 GPData

The `eval(...)` method has several arguments, only two of which should be nonobvious: `ec.gp.ADFStack` and `ec.gp.GPData`. We will discuss `ADFFStack` later in Section 5.2.10. The `GPData` object is a simple data object passed around amongst your `GPNodes` when they execute one another. It's your opportunity to pass data from node to node. In the example above, it's how the values are passed from the children to their parents: for example, it's how the `Sub` node returns its value to the `Sin` node. It's also possible that the parent needs to pass data to its child: and the `GPData` object can be used like that as well.

Typically a single `GPData` object is created and handed to the `GPNodes`, and then they hand it to one another during execution, reusing it. This avoids making lots of clones of a `GPData` object during execution. Your prototypical `GPData` instance normally managed by the `GPProblem` (Section ??, coming up). We'll see how to specify it in the parameters then.

In the simplest case, your nodes don't need to pass any data to each other at all. For example, in the Artificial Ant problem, the nodes are simply executed in a certain order and don't pass or return any data. In this case, you can simply use `GPData` itself: there is no need to specify a subclass.

More often, our `GPData` object needs to hold the return value from a child. If you are holding a simple piece of data (like a double or an int) also just need to implement a single method, `copyTo(...)`, which copies the data from your `GPData` object into another, then returns it:

```
public GPData copyTo(GPData other);
```

In this case, it's simple:

```
package ec.app.myapp;
import ec.gp.*;
public class MyData extends GPData
{
    public double val;
    public void copyTo(GPData other)
        { ((MyData)other).val = val; return other; }
}
```

Now it might be the case that you need to hold more complex data. For example, what if you had an array of doubles? In this case you'd need to either clone or copy the data during the `copyTo(...)` operation. Additionally, `GPData` is a Prototype and so it needs to implement the `clone()` method as a deep clone. The default implementation just does a light clone. But with your array of doubles, you'd need to clone that. Altogether you might have something like this:

```

package ec.app.myapp;
import ec.gp.*;
public class MyData extends GPData
{
    public double[15] val = new double[15];
    public void copyTo(GPData other)
    {
        System.arraycopy(val, 0, ((MyData)other).val, 0, val.length);
        return other;
    }

    public Object clone()
    {
        MyData other = (MyData)(super.clone());
        other.val = (double[])(val.clone());
        return other;
    }
}

```

The important thing to note is that when you perform `copyTo(...)` or `clone()`, the resulting other object should not be sharing any data in common with you except constant (immutable, read-only) data. Why the two methods? Certainly most things `copyTo(...)` performs could be done with `clone()`. The reason for `copyTo(...)` is entirely for efficiency when using Automatically Defined Functions (Section 5.2.10). Perhaps in the future we might obviate the need for its use.

Now that you've defined the `GPData` object, you'll need to specify its use. This is done as follows:

```
eval.problem.data = ec.app.myapp.MyData
```

5.2.3.2 KozaFitness

You can use any fitness you like for GP. But it's common to use a particular fitness function popularized by John Koza [6]. This fitness object contains a *standardized fitness* in which 0 is the ideal result and Infinity is worse than the worst possible result. Note that this isn't yet the correct fitness according to the `ec.Fitness`. Instead, when asked for fitness, the function converts this to an *adjusted fitness* in which 1 is the ideal result and 0 is worse than the worst possible result, using the function $adjusted = \frac{1}{1+standardized}$. The adjusted fitness makes this a valid `Fitness` subclass. The GP fitness also has an auxiliary variable, *hits*, which originally was meant to indicate how many optimal subsolutions were discovered: it's printed out in the statistics and used for nothing else; use it as you like. This fitness is set as:

```
pop.subpop.0.species.fitness = ec.gp.koza.KozaFitness
```

The standard fitness-setting function for this class is:

```
public final void setStandardizedFitness(EvolutionState state, double value);
```

You can get (or set) the hits as:

```
int hits = myKozaFitness.hits;
```

Note that though the *adjusted fitness* is returned by the `fitness()` method, and is thus used by selection methods such as `ec.select.FitProportionateSelection`, the *standardized fitness* is what's used in the comparison methods `betterThan()` and `equivalentTo()`, as well as `isIdealFitness()`. This is because it's possible to convert different standardized fitness values into the adjusted fitness and have them come out equal due to floating

point inaccuracy in division.

5.2.3.3 GPPProblem

GPPProblem is the subclass of Problem which you will define for evaluating candidate GP solutions. GPPProblems contain two variables:

```
public ADFStack stack;
public GPData input;
```

The `ec.gp.ADFStack`— is the mechanism used to handle Automatically Defined Functions (or ADFs, see Section 5.2.10). You'll usually not bother with this variable, it's handled automatically for you.

However, the second variable, `input`, will be of considerable interest to you: it's the `GPData` object for you to pass among your `GPNodes`. It's automatically loaded via this parameter, as mentioned earlier in Section 5.2.3.1 (`GPData`):

```
eval.problem.data = ec.app.myapp.MyData
```

Your primary task, done during `setup(...)`, will be to verify that the `GPData` object is of the subclass you'll be using, along these lines:

```
// verify that our GPData is of the right class (or subclasses from it)
if (!input instanceof MyData)
    state.output.fatal("GPData class must subclass from " + MyData.class,
        base.push(P_DATA), null);
```

Then during evaluation (`evaluate(...)` or `describe(...)`) of a `GPIndividual`, you'll use your copy of the input prototype and hand it to your top-level `GPNode` to evaluate.

With all that out of our hair, let's construct the Problem. Let's attempt to create a GP tree which closely matches a set of data we've created: we'll generate the data from the function $z = \sin(x \times y) - \sin(x) - x \times y$, in the range $[0, 1)$ for both x and y . What we'll do is define n $\langle x, y \rangle$ data points up front, then evaluate our individuals. For each data point, we'll set some global variables accessible by the X and Y `GPNodes`. The individual will return a value, which we'll compare against the expected z result. The fitness will be the sum of squared differences.

```
package ec.app.myapp;
import ec.gp.*;
import ec.simple.*;
import ec.*;
import ec.gp.koza.*;
public class MyProblem extends GPPProblem implements SimpleProblemForm {
    final static int N = 20;
    int current;
    double[] Xs = new double[N]; // will be pointer-copied in clone(), which is okay
    double[] Ys = new double[N]; // likewise
    double[] Zs = new double[N]; // likewise

    public void setup(EvolutionState state, Parameter base) {
        super.setup(state, base);

        // verify that our GPData is of the right class (or subclasses from it)
        if (!input instanceof MyData)
            state.output.fatal("GPData class must subclass from " + MyData.class,
                base.push(P_DATA), null);

        // generate N random <x, y, z = f(x,y)> tuples
```

```

    for(int i = 0; i < N; i++) {
        double x, y;
        Xs[i] = x = state.random[0].nextDouble();
        Ys[i] = y = state.random[0].nextDouble();
        Zs[i] = Math.sin(x * y) - Math.sin(x) - x * y;
    }
}

public void evaluate(final EvolutionState state, Individual ind,
    int subpopulation, int threadnum) {
    if (!ind.evaluated) { // don't bother reevaluating

        MyData input = (MyData)(this.input);

        double sum = 0.0;

        // for each tuple, evaluate the individual. For good measure reset
        // the GPData first, though in this example it's not necessary
        input.val = 0;
        for(current = 0; current < N; current++) // note: an instance variable
            ((GPIndividual)ind).trees[0].child.eval(
                state, threadnum, input, stack, ((GPIndividual)ind),this);
        sum += (input.val * input.val);

        // set the fitness and the evaluated flag
        KozaFitness f = (KozaFitness)(ind.fitness);
        f.setStandardizedFitness(state, sum);
        f.hits = 0; // don't bother using this
        ind.evaluated = true;
    }
}
}

```

5.2.3.4 GPNode Subclasses

Now let's implement our five GPNode subclasses. Each will implement `toString()` to print out the node name, and also `eval(...)` discussed earlier. It's also common to implement the method `checkConstraints()` to do a final sanity-check on the node (whether it has the right number of children, etc.) but it's not necessary, and we'll omit it here. Instead we implement the simpler `expectedChildren()` method, which is called by the default `checkConstraints()` implementation. `expectedChildren()` simply returns the expected number of children to the node, or a negative number, which means "the number of children could be anything". The value returned by `expectedChildren()` is checked against the type constraints of this node as a sanity check.

First the terminals:

```

package ec.app.myapp;
import ec.*;
import ec.gp.*;
public class X extends GPNode {
    public String toString() { return "x" };
    public int expectedChildren() { return 0; }
    public void eval(EvolutionState state, int thread, GPData input,
        ADFStack stack, GPIndividual individual, GPPProblem problem) {
        MyData data = (MyData) input;
        MyProblem prob = (MyProblem) problem;

        data.val = problem.Xs[problem.current]; // return current X value to parent
    }
}

```

... and...

```

package ec.app.myapp;
import ec.*;
import ec.gp.*;
public class Y extends GPNode {
    public String toString() { return "y" };
    public int expectedChildren() { return 0; }
    public void eval(EvolutionState state, int thread, GPData input,
        ADFStack stack, GPIndividual individual, GPPProblem problem) {
        MyData data = (MyData) input;
        MyProblem prob = (MyProblem) problem;

        data.val = problem.Ys[problem.current]; // return current Y value to parent
    }
}

```

Next the Sine:

```

package ec.app.myapp;
import ec.*;
import ec.gp.*;
public class Sin extends GPNode {
    public String toString() { return "sin" };
    public int expectedChildren() { return 1; }
    public void eval(EvolutionState state, int thread, GPData input,
        ADFStack stack, GPIndividual individual, GPPProblem problem) {
        MyData data = (MyData) input;
        MyProblem prob = (MyProblem) problem;

        children[0].eval(state, thread, data, stack, individual, prob);
        data.val = Math.sin(data.val);
    }
}

```

Next the Multiply and Subtract:

```

package ec.app.myapp;
import ec.*;
import ec.gp.*;
public class Mul extends GPNode {
    public String toString() { return "*" };
    public int expectedChildren() { return 2; }
    public void eval(EvolutionState state, int thread, GPData input,
        ADFStack stack, GPIndividual individual, GPPProblem problem) {
        MyData data = (MyData) input;
        MyProblem prob = (MyProblem) problem;

        children[0].eval(state, thread, data, stack, individual, prob);
        double val1 = data.val;

        children[1].eval(state, thread, data, stack, individual, prob);
        data.val = val1 * data.val;
    }
}

```

```

package ec.app.myapp;
import ec.*;
import ec.gp.*;
public class Sub extends GPNode {
    public String toString() { return "-" };
    public int expectedChildren() { return 2; }
    public void eval(EvolutionState state, int thread, GPData input,
        ADFStack stack, GPIndividual individual, GPPProblem problem) {
        MyData data = (MyData) input;
        MyProblem prob = (MyProblem) problem;

        children[0].eval(state, thread, data, stack, individual, prob);
        double val1 = data.val;

        children[1].eval(state, thread, data, stack, individual, prob);
        data.val = val1 - data.val;
    }
}

```

5.2.3.5 Statistics

The default statistics class for GP is `SimpleStatistics`. However, the GP package has a `Statistics` subclass designed for doing the same basic stuff as `SimpleShortStatistics` (Section 3.7.2), but with some extra GP-specific tree statistics. You can turn it on like this:

```
stat = ec.gp.koza.KozaShortStatistics
```

This statistics object has all the basic features of `SimpleShortStatistics`, including the `do-time`, `do-size`, `do-subpops`, and `modulus` parameters. Additionally it adds a new parameter which you can turn on like this:

```
stat.child.0.do-depth = true
```

This parameter enables tree depth information.

Beyond depth options, the full form of output differs from `SimpleShortStatistics` in that it reports per-tree

information as well, like this:

1. The generation number
2. (If `do-time` is true) How long initialization took in milliseconds, or how long the previous generation took to breed to form this generation
3. (If `do-time` is true) How long evaluation took in milliseconds this generation
4. *Once for each subpopulation...*
 - (a) (If `do-depth` is true) Output of the form [a b c . . .], representing the average depth of each tree *a, b, c*, etc. of an individual this generation for this subpopulation
 - (b) (If `do-size` is true) Output of the form [a b c . . .], representing the average size of each tree *a, b, c*, etc. of an individual this generation for this subpopulation
 - (c) (If `do-size` is true) The average size of an individual this generation for this subpopulation
 - (d) (If `do-size` is true) The average size of an individual so far in the run for this subpopulation
 - (e) (If `do-size` is true) The size of the best individual this generation for this subpopulation
 - (f) (If `do-size` is true) The size of the best individual so far in the run for this subpopulation
 - (g) The mean fitness of the subpopulation for this generation
 - (h) The best fitness of the subpopulation for this generation
 - (i) The best fitness of the subpopulation so far in the run
5. (If `do-depth` is true) Output of the form [a b c . . .], representing the average depth of each tree *a, b, c*, etc. of an individual this generation
6. (If `do-size` is true) Output of the form [a b c . . .], representing the average size of each tree *a, b, c*, etc. of an individual this generation
7. (If `do-size` is true) The average size of an individual this generation
8. (If `do-size` is true) The average size of an individual so far in the run
9. (If `do-size` is true) The size of the best individual this generation
10. (If `do-size` is true) The size of the best individual so far in the run
11. The mean fitness of the entire population for this generation
12. The best fitness of the entire population for this generation
13. The best fitness of the entire population so far in the run

5.2.4 Initialization

To use GP we'll need to define the initializer as a subclass of `ec.gp.GPInitializer`:

```
init = ec.gp.GPInitializer
```

ECJ has traditionally followed the *lil-gp* default for disallowing duplicates in the initial Population: if a duplicate is created, ECJ will try 100 times to create another non-duplicate Individual in its stead. If this fails, the last duplicate created will be allowed. We say this in the standard way:

```
pop.subpop.0.duplicate-retries = 100
```

To create trees. ECJ relies on a tree-creation algorithm in the form of an `ec.gp.GPNodeBuilder`, part of the `GPTreeConstraints` object. The `GPNodeBuilder` for `GPTreeConstraints 0` is specified like this:

```
gp.tc.0.init = ec.gp.koza.HalfBuilder
```

ECJ provides quite a number of node builders in the `ec.gp.koza` and `ec.gp.build` packages. You request a tree with the following function:

```
public abstract GPNode newRootedTree(EvolutionState state, GPType type,
                                     int thread, GPNodeParent parent, GPFunctionSet set,
                                     int argposition, int requestedSize);
```

This method builds a tree of `GPNodes` whose root return type is compatible with `type`, attached to the given `GPNodeParent`, at position `argposition`, and built from clones of `GPNodes` in the function set `set`. The root node is returned. Several `GPNodeBuilders` also produce the tree of the `requestedSize`: others ignore this function. You can also ask the `GPNodeBuilder` to pick its own tree size from a distribution specified by the user in parameters, by passing `ec.gp.GPNodeBuilder.NOSIZEGIVEN` for the size (this is the usual thing done by most initialization procedures).

If you are using a `GPNodeBuilder` which generates trees of a certain size, and `ec.gp.GPNodeBuilder.NOSIZEGIVEN` is used (as usual), then you can specify a distribution of sizes in two ways. First, you can have the `GPNodeBuilder` pick a size uniformly from among a minimum and maximum size, for example:

```
gp.tc.0.init.min-size = 10
gp.tc.0.init.max-size = 20
```

Alternatively you can specify the distribution of sizes manually. To stipulate probabilities sizes for 1, 2, 3, 4, and 5, you'd say:

```
gp.tc.0.init.num-sizes = 5
gp.tc.0.init.size.0 = 0.2
gp.tc.0.init.size.1 = 0.1
gp.tc.0.init.size.2 = 0.2
gp.tc.0.init.size.3 = 0.25
gp.tc.0.init.size.4 = 0.25
```

ECJ has a whole bunch of `GPNodeBuilder` algorithms available to you. I wrote a shoot-out paper describing and comparing nearly all of these algorithms [12]. Here is the run-down:

- `ec.gp.koza.FullBuilder` generates full trees using Koza's FULL algorithm. You cannot request a size. It requires a minimum and maximum depth, for example:

```
gp.tc.0.init = ec.gp.koza.FullBuilder
gp.tc.0.init.min-depth = 2
gp.tc.0.init.max-depth = 6
```

Alternatively:

```
gp.koza.full.min-depth = 2
gp.koza.full.max-depth = 6
```

- `ec.gp.koza.GrowBuilder` generates arbitrary trees depth-first using Koza's GROW algorithm. You cannot request a size. It requires a minimum and maximum depth, for example:

```
gp.tc.0.init = ec.gp.koza.GrowBuilder
gp.tc.0.init.min-depth = 2
gp.tc.0.init.max-depth = 6
```

Alternatively:

```
gp.koza.grow.min-depth = 2
gp.koza.grow.max-depth = 6
```

- `ec.gp.koza.HalfBuilder` generates arbitrary trees depth-first using Koza's RAMPED HALF-AND-HALF algorithm. You cannot request a size. This is nothing more than flipping a coin of probability `growp` to decide whether to use GROW or FULL. `HalfBuilder` is the default builder for creating GP trees in ECJ, but it's not particularly good. It requires a minimum and maximum depth, and the probability of doing GROW, for example:

```
gp.tc.0.init = ec.gp.koza.HalfBuilder
gp.tc.0.init.min-depth = 2
gp.tc.0.init.max-depth = 6
gp.tc.0.init.growp = 0.5
```

Alternatively:

```
gp.koza.half.min-depth = 2
gp.koza.half.max-depth = 6
gp.koza.half.growp = 0.5
```

- `ec.gp.build.PTC1` is a modification of GROW which guarantees that trees will be generated with a given mean. You cannot request a size. Additionally, each terminal and nonterminal can specify its probability of being chosen from the function set as `PTC1` constructs the tree. `PTC1` requires an expected size and a maximum depth:

```
gp.tc.0.init = ec.gp.build.PTC1
gp.tc.0.init.expected-size = 10
gp.tc.0.init.max-depth = 6
```

Alternatively:

```
gp.build.ptc1.expected-size = 10
gp.build.ptc1.max-depth = 6
```

`PTC1` requires that its function sets adhere to the interface `ec.gp.build.PTCFunctionSetForm`. This interface contains three tables of probabilities for your `GPNodes` to be selected:

```
public [] terminalProbabilities(int type);
public double[] nonterminalProbabilities(int type);
public double[] nonterminalSelectionProbabilities(int expectedTreeSize);
```

The first function returns, for a given `GPTYPE` number, a distribution of desired selection probabilities for terminals of that type. The order of the terminals is the same as the following array in `GPFunctionSet`:

```
public GPNode[type] [] terminals;
```

The second function returns, for a given `GPTYPE` number, a distribution of desired selection probabilities for nonterminals of that type. The order of the nonterminals is the same as the following array in

GPFunctionSet:

```
public GPNode[type] [] nonterminals;
```

The final function returns, for a given desired tree size, the probability that a nonterminal (of a given GPType return type) should be selected over a terminal of the same GPType. This is only used by PTC1, not PTC2 below.

You don't need to implement this interface: the `ec.gp.build.PTCFunctionSet` class does it for you:

```
gp.fs.size = 1
gp.fs.0 = ec.gp.build.PTCFunctionSet
gp.fs.0.name = f0
```

This function set computes all the above probabilities from user-specified probabilities as parameters. The probabilities are specified by each `GPNodeConstraints` object. Following the example we started in Section 5.2.2, we might state that the terminals X and Y (node constraints 0) should be picked with 0.5 probability each, and the nonterminals Mul, Sub (node constraints 2) and Cos (node constraints 1) should be picked with 0.3, 0.3, and 0.4 probability:

```
gp.nc.0.prob = 0.5
gp.nc.1.prob = 0.3
gp.nc.2.prob = 0.4
```

What if you wanted Mul and Sub to have different probabilities? You'd need to create different `GPNodeConstraints`. For example, we could create a new, separate `GPNodeConstraints` for Sub:

```
gp.nc.size = 4
gp.nc.3 = ec.gp.GPNodeConstraints
gp.nc.3.name = nc3
gp.nc.3.returns = nil
gp.nc.3.size = 2
gp.nc.3.child.0 = nil
gp.nc.3.child.1 = nil
```

Now we assign it to Sub:

```
gp.fs.0.func.3 = ec.app.myapp.Sub
gp.fs.0.func.3.nc = nc3
```

...and last change the probabilities of Sub and Mul to be different:

```
gp.nc.0.prob = 0.5
gp.nc.1.prob = 0.3
gp.nc.2.prob = 0.25
gp.nc.3.prob = 0.35
```

- `ec.gp.build.PTC2` generates trees near to a desired size (which you request) by picking randomly from the current outer edge in the tree and adding a node. When the tree is large enough, all the remaining edge slots are filled with terminals. Additionally, each terminal and nonterminal can specify its probability of being chosen from the function set as PTC2 constructs the tree. PTC2 requires a desired size and a maximum depth:

```
gp.tc.0.init = ec.gp.build.PTC2
gp.tc.0.init.expected-size = 10
gp.tc.0.init.max-depth = 6
```

Alternatively:

```
gp.build.ptc2.expected-size = 10
gp.build.ptc2.max-depth = 6
```

Like PTC1, PTC2 requires that function sets adhere to the `PTCFunctionSetForm` interface. Just use `PTCFunctionSet`.

- `ec.gp.build.RandomBranch` generates trees near to a desired size (which you request) using the `RANDOMBRANCH` algorithm. Beyond the size distributions, this algorithm has no additional parameters.
- `ec.gp.build.Uniform` generates trees near to a desired size (which you request) using the `UNIFORM` algorithm, which selects trees of any tree size. You can select sizes either using the user distribution, or according to the natural distribution of tree sizes. To do the second, you'd say:

```
gp.tc.0.init = ec.gp.build.Uniform
gp.tc.0.init.true-dist = true
```

Alternatively:

```
gp.breed.uniform.true-dist = true
```

WARNING: This algorithm is complex and I fear it may be suffering from bit-rot. I have been told it's not working properly any more but have not debugged it yet.

- `ec.gp.build.RandTree` (by Alexander Chircop) generates trees near to a desired size (which you request) using the `RAND_TREE` algorithm, which selects trees distributed uniformly using Dyck words. No extra parameters are needed beyond the tree size selection. **WARNING:** I suspect this algorithm may have some bugs.

5.2.5 Breeding

ECJ has a large number of breeding pipeline operators for GP trees. This includes the most common operators used in GP (`ec.gp.koza.Crossover`, `ec.gp.koza.Mutation`), and several more found in the `ec.gp.breed` package.

Pipelines generally pick a single `GPTree` in a given `GPIndividual` in which to do mutation or crossover. In most cases you can lock down the specific `GPTree`, or let the pipeline choose it at random.

Once they've picked a `GPTree`, GP breeding operators often need to choose `GPNodes` in the tree in which to perform crossover, mutation, etc. To do this, they make use of a `ec.gp.GPNodeSelector`. A `GPNodeSelector` is a simple interface for picking nodes, consisting of the following methods:

```
public abstract void reset();
public abstract GPNode pickNode(EvolutionState s, int subpopulation,
                                int thread, GPIndividual ind, GPTree tree);
```

When a breeding pipeline needs to pick a node in a particular `GPTree` of a particular `GPIndividual`, it first will call the `reset()` to get the `GPNodeSelector` to ready itself, then it will call `pickNode(...)` to select a node. If the breeding pipeline needs another node in the same tree, it can call `pickNode(...)` again as many times as necessary.

The standard `GPNodeSelector` is `ec.gp.koza.KozaNodeSelector`, which picks certain kinds of nodes with different probabilities. The kinds of nodes you can state probabilities for are: the root, nonterminals, terminals, and all nodes. The most common settings are (here as default parameters):

```
gp.koza.ns.terminals = 0.1
gp.koza.ns.nonterminals = 0.9
gp.koza.ns.root = 0.0
```

This says to pick terminals 10% of the time, nonterminals 90% of the time, the root (specifically) 0% of the time and any arbitrary node 0% of the time. The arbitrary-node percentage is whatever is left over from the other three percentages. (The root could still be picked, since it's a nonterminal or a terminal — but it won't be *specialy* picked).

Why might the breeding pipeline need to call `pickNode(...)` repeatedly? Most likely because the chosen GPNode has type constraint problems. For example, in order to do crossover between the subtrees rooted by two GPNodes, the nodes need to be type-compatible with one another's parent nodes: otherwise the tree locations wouldn't be valid. Pipelines with these issues will try some n times to pick compatible nodes; if they fail all n times, the parents are returned rather than the generated children.

Here are the breeding pipelines that come with ECJ. In each case, let's presume that we're placing the pipeline as the root pipeline of Subpopulation 0, parameter-wise:

- `ec.gp.koza.CrossoverPipeline` performs standard subtree crossover: it requests a GPIndividual from each of its two sources; then a tree is selected from each GPIndividual, then a node is selected in each tree, and finally the two subtrees rooted by those nodes are swapped. CrossoverPipeline has several parameters. The first four:

```
pop.subpop.0.species.pipe.tries = 1
pop.subpop.0.species.pipe.maxdepth = 17
pop.subpop.0.species.pipe.toss = false

% This one is undefined initially but you can define it:
% pop.subpop.0.species.pipe.maxsize = ...
```

This tells CrossoverPipeline that children may not have a depth which exceeds 17 (the common value). The pipeline will try just one times to find type-valid and depth-legal crossover points before giving up and just returning the parents instead. This is the most common setting in Genetic Programming. If `toss=true` then only one child is returned — the other is thrown away. The default value for `toss` is false.

The CrossoverPipeline also can be set, via the `maxsize` parameter, to not generate children which exceed some number of nodes in any one tree. Initially this is unset, meaning that there is no maximum size.

```
pop.subpop.0.species.pipe.tree.0 = 0
pop.subpop.0.species.pipe.tree.1 = 0
```

This tells CrossoverPipeline that it should pick GPNodes in GPTree 0 of each individual. If either of these parameters is missing entirely, then CrossoverPipeline will pick that tree at random. At any rate, the GPTrees chosen must have the same GPTreeConstraints. Finally we have:

```
pop.subpop.0.species.pipe.ns.0 = ec.gp.koza.KozaNodeSelector
pop.subpop.0.species.pipe.ns.1 = same
```

This states that the GPNodeSelector for both GPIndividuals should be a KozaNodeSelector. You can state them independently or node selector 1 can be same.

The default parameter base versions for all of these would be:

```
gp.koza.xover.tries = 1
gp.koza.xover.maxdepth = 17
gp.koza.xover.toss = false
gp.koza.xover.tree.0
gp.koza.xover.tree.1
gp.koza.xover.ns = ec.gp.koza.KozaNodeSelector
```

Important note: the default version of the parameter for node selectors is just `ns`. There's no `ns.0` or `ns.1`.

- `ec.gp.koza.MutationPipeline` performs standard subtree mutation: it requests a `GPIndividual` from a single source; then a tree is selected; then a node is selected in that tree; and finally the subtree rooted by that node is replaced in its entirety by a randomly-generated tree.

`MutationPipeline` has many parameters similar to `CrossoverPipeline`:

```
pop.subpop.0.species.pipe.tries = 1
pop.subpop.0.species.pipe.maxdepth = 17
pop.subpop.0.species.pipe.tree.0 = 0
pop.subpop.0.species.pipe.ns = ec.gp.koza.KozaNodeSelector

% This one is undefined initially but you can define it:
% pop.subpop.0.species.pipe.maxsize = ...
```

Note that the node selector is just `ns`, not `ns.0`.

The replacing subtree is generated using a `GPNodeBuilder`. The standard `GPNodeBuilder` is a `GrowBuilder` with the following default values:

```
gp.koza.grow.min-depth = 5
gp.koza.grow.max-depth = 5
```

These are strange default values, but that's common GP original settings. You stipulate the `GPNodeBuilder` as:

```
pop.subpop.0.species.pipe.build.0 = ec.gp.koza.GrowBuilder
```

Though `GrowBuilder` ignores size demands, if you replaced with another builder such as `PTC2`, you can also optionally stipulate that the replacing subtree must be about the same size as the original subtree. Here's the parameter:

```
pop.subpop.0.species.pipe.equal = true
```

The default setting is `false`.

The default parameter base versions for all of these would be:

```
gp.koza.mutate.tries = 1
gp.koza.mutate.maxdepth = 17
gp.koza.mutate.tree.0 = 0
gp.koza.mutate.pipe.ns = ec.gp.koza.KozaNodeSelector
gp.koza.mutate.build.0 = ec.gp.koza.GrowBuilder
gp.koza.mutate.equal = true
```

- `ec.gp.breed.InternalCrossoverPipeline` selects two `GPNodes` in the same `GPIndividual`, such that neither `GPNode` is in the subtree rooted by the other. The `GPNodes` may be in different `GPTrees`, or they may be in the same `GPTree`. It then swaps the two subtrees.

`InternalCrossoverPipeline`'s parameters are essentially identical to those in `CrossoverPipeline`, except for a missing `maxsize` parameter. For example:

```

pop.subpop.0.species.pipe.tries = 1
pop.subpop.0.species.pipe.maxdepth = 17
pop.subpop.0.species.pipe.tree.0 = 0
pop.subpop.0.species.pipe.tree.1 = 0
pop.subpop.0.species.pipe.ns.0 = ec.gp.koza.KozaNodeSelector
pop.subpop.0.species.pipe.ns.1 = same

```

The default parameter base versions for all of these would be:

```

gp.breed.internal-xover.tries = 1
gp.breed.internal-xover.maxdepth = 17
gp.breed.internal-xover.toss = false
gp.breed.internal-xover.tree.0
gp.breed.internal-xover.tree.1
gp.breed.internal-xover.ns = ec.gp.koza.KozaNodeSelector

```

Important note: just as is the case for CrossoverPipeline, the default version of the parameter for node selectors is just `ns`. There's no `ns.0` or `ns.1`.

- `ec.gp.breed.MutatePromotePipeline` selects a `GPNode`, other than the root, and replaces its parent (and its parent's subtree) with the `GPNode` and its subtree. This was called the *PromoteNode* algorithm in [1] and is similar to the *Deletion* algorithm in [16].

`MutatePromotePipeline`'s parameters are pretty simple. Because its constraints are tighter, it doesn't use a `GPNodeSelector`: instead it searches among all nodes in the tree to find one which is type-compatible with its parent. thus its parameters are simply the number of times it tries before giving up, and returning the original tree. Like previous methods, if the tree parameter doesn't exist, a tree is picked at random (which is usually what'd you'd want anyway).

```

pop.subpop.0.species.pipe.tries = 1
pop.subpop.0.species.pipe.tree.0 = 0

```

The default parameter base versions:

```

gp.breed.mutate-promote.tries = 1
gp.breed.mutate-promote.tree.0

```

- `ec.gp.breed.MutateDemotePipeline` selects a `GPNode`, then replaces the node with a new nonterminal. The old Node becomes a child of the new node at a random argument location, and the remaining child slots are filled with terminals. This was called the *DemoteNode* algorithm in [1] and is similar to the *Insertion* algorithm in [16].

`MutateDemotePipeline` is similar to `MutatePromotePipeline`: it doesn't use a `GPNodeSelector`, and tries a certain number of times to find valid node points before giving up and returning the tree. parameters are pretty simple. Because its constraints are tighter, it doesn't use a `NodeSelector`: instead it searches among all nodes in the tree to find one which is type-compatible with its parent, and which wouldn't create a tree deeper than a maximum legal value. Like previous methods, if the tree parameter doesn't exist, a tree is picked at random (which is usually what'd you'd want anyway).

```

pop.subpop.0.species.pipe.tries = 1
pop.subpop.0.species.pipe.maxdepth = 17
pop.subpop.0.species.pipe.tree.0 = 0

```

The default parameter base versions:

```
gp.breed.mutate-demote.tries = 1
gp.breed.mutate-demote.maxdepth = 17
gp.breed.mutate-demote.tree.0 = 0
```

- `ec.gp.breed.MutateSwapPipeline` selects a `GPNode` with at least two children, then selects two children of that node such that each is type-compatible with the other. Then it swaps the two subtrees rooted by those children.

`MutateSwap`'s parameters are simple because it doesn't use a `GPNodeSelector` (the constraints are too complex). You simply specify the tree (or have one picked at random if none is specified) and the number of tries:

```
pop.subpop.0.species.pipe.tries = 1
pop.subpop.0.species.pipe.tree.0 = 0
```

The default parameter base versions for all of these would be:

```
gp.breed.mutate-swap.tries = 1
gp.breed.mutate-swap.tree.0
```

- `ec.gp.breed.MutateOneNodePipeline` selects a `GPNode`, then replaces that node with a different node of the same arity and type constraints. This was called the *OneNode* algorithm in [1].

`MutateOneNodePipeline` uses a `GPNodeSelector` to pick the node. You also specify the tree number: or if you don't specify anything, one will be picked at random (which is usually what'd you'd want).

```
pop.subpop.0.species.pipe.ns.0 = ec.gp.koza.KozaNodeSelector
pop.subpop.0.species.pipe.tree.0 = 0
```

The default parameter base versions:

```
gp.breed.mutate-one-node.ns.0 = ec.gp.koza.KozaNodeSelector
gp.breed.mutate-one-node.tree.0 = 0
```

- `ec.gp.breed.MutateAllNodesPipeline` selects a `GPNode`, then for *every* node in the subtree rooted by the `GPNode`, it replaces each node with a different node of the same arity and type constraints. This highly destructive operator was called the *AllNodes* algorithm in [1].

`MutateAllNodesPipeline` uses a `GPNodeSelector` to pick the `GPNode`. You also specify the tree number: or if you don't specify anything, one will be picked at random (which is usually what'd you'd want).

```
pop.subpop.0.species.pipe.ns.0 = ec.gp.koza.KozaNodeSelector
pop.subpop.0.species.pipe.tree.0 = 0
```

The default parameter base versions:

```
gp.breed.mutate-one-node.ns.0 = ec.gp.koza.KozaNodeSelector
gp.breed.mutate-one-node.tree.0 = 0
```

- `ec.gp.breed.RehangPipeline` is an oddball mutator of my own design meant to be highly destructive. It selects a nonterminal other than the root, and designates it the "new root". It then picks a child subtree of this new root, which is disconnected from its parent. The new root becomes the root of the tree. The original parent of the new root becomes the new root's child, filling the spot vacated by the disconnected subtree. The grandparent then fills the spot vacated by the parent, and so on, clear up to the root. Then finally the disconnected subtree fills remaining spot. Figure 5.4 shows this procedure. There are two parameters, as usual:

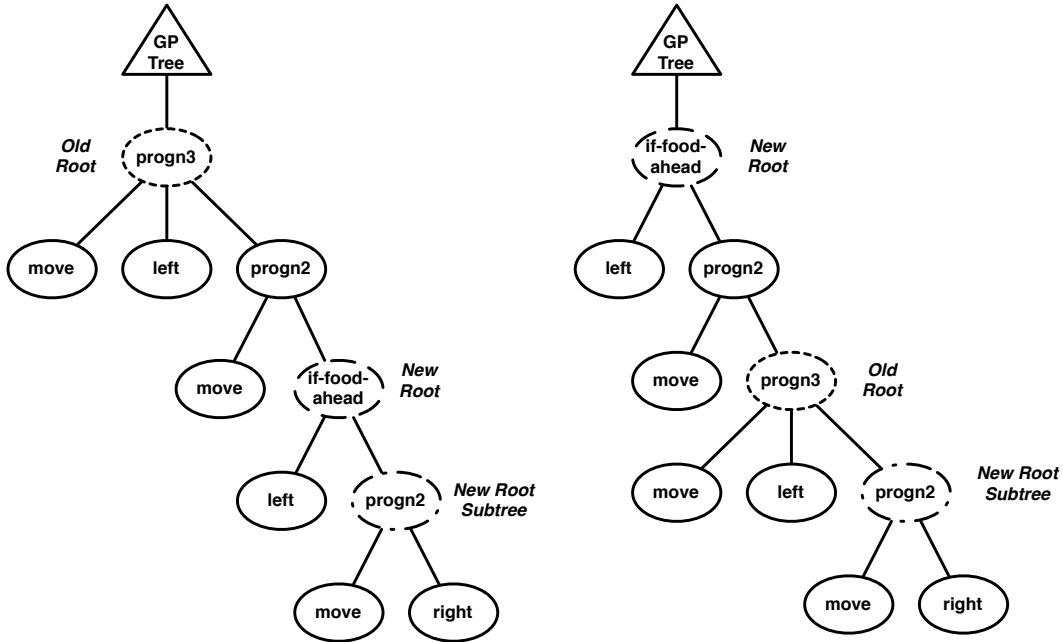

Figure 5.4 Rehanging a tree. A new root is chosen at random from among the nonterminals except for the original root. Then a subtree of that new root is chosen at random and disconnected. The tree is then rehanged as shown: the parent of the new root becomes its child; the grandparent becomes the parent's child, and so on up to the root. The disconnected subtree then fills the remaining spot.

```
pop.subpop.0.species.pipe.tries = 1
pop.subpop.0.species.pipe.tree.0 = 0
```

The default parameter base versions for all of these would be:

```
gp.breed.rehang.tries = 1
gp.breed.rehang.tree.0
```

Warning: Because of the complexity of its rehanging process, RehangPipeline ignores all typing information.

- `ec.gp.breed.MutateERCPipeline` works similarly to the *Gaussian* algorithm in [1]. The algorithm picks a random node in a random tree in the `GPIndividual`, then for every Ephemeral Random Constant (ERC) in the subtree rooted by that node, it calls `mutateERC()` on that ERC. ERCs are discussed later in Section 5.2.9. As usual, the two common parameters:

```
pop.subpop.0.species.pipe.tries = 1
pop.subpop.0.species.pipe.tree.0 = 0
```

The default parameter base versions for all of these would be:

```
gp.breed.mutate-erc.tries = 1
gp.breed.mutate-erc.tree.0
```

If you wished to mutate the ERCs in the *entire tree*, you could set the node selector parameters like this:

```

gp.breed.mutate-erc.ns.0 = ec.gp.koza.KozaNodeSelector
gp.breed.mutate-erc.ns.0.terminals = 0.0
gp.breed.mutate-erc.ns.0.nonterminals = 0.0
gp.breed.mutate-erc.ns.0.root = 1.0

```

- `ec.gp.breed.SizeFairCrossoverPipeline` implements the *size fair* and *homologous* crossover methods described in [8]. `SizeFairCrossoverPipeline` has many parameters in common with `CrossoverPipeline`, which should look familiar, something like:

```

pop.subpop.0.species.pipe.tries = 1
pop.subpop.0.species.pipe.maxdepth = 17
pop.subpop.0.species.pipe.toss = false
pop.subpop.0.species.pipe.ns.0 = ec.gp.koza.KozaNodeSelector
pop.subpop.0.species.pipe.ns.1 = same
% These are unset by default but you can set them to lock down
% the trees being crossed over
% pop.subpop.0.species.pipe.tree.0 = 0
% pop.subpop.0.species.pipe.tree.1 = 0

```

The default parameter base versions for all of these would be:

```

gp.breed.size-fair.tries = 1
gp.breed.size-fair.maxdepth = 17
gp.breed.size-fair.toss = false
gp.breed.size-fair.ns = ec.gp.koza.KozaNodeSelector
% These are unset by default but you can set them to lock down
% the trees being crossed over
% gp.breed.size-fair.tree.0 = ...
% gp.breed.size-fair.tree.1 = ...

```

By default `SizeFairCrossoverPipeline` will perform **size-fair crossover**, defined as follows. First, it finds a crossover point in the first parent in a fashion identical to `CrossoverPipeline`. But to find the crossover point in the second parent, it first computes the size s_1 of the subtree in the first parent. It then calculates the size of every subtree in the second parent, and discards from consideration any subtrees whose size s_2 is $s_2 > 1 + 2s_1$. From the remainder, it then counts the number of subtrees smaller, equal to, and larger than s_1 (call these $n_<$, $n_=>$ and $n_>$), and likewise the means of the smaller and larger subtrees (call these $mu_<$ and $mu_>$).

If $n_< = 0$ or if $n_> = 0$, then a random subtree is selected from among the subtrees exactly the same size as s_1 . Thus terminals are always crossed over with terminals. Otherwise, we decide on selecting an equal, smaller, or larger subtree with the following probabilities:

$$\begin{aligned}
 p_&= &= \frac{1}{s_1} \\
 p_> &= \frac{1 - p_&=}{n_> \times \left(1 + \frac{\mu_>}{\mu_<}\right)} \\
 p_< &= 1 - (p_&= + p_>)
 \end{aligned}$$

The idea is to select bigger or smaller subtrees randomly such that the mean stays the same. Once we have decided on bigger or smaller or equal subtrees, we then select a size uniformly from among the sizes of subtrees appearing in that set. If there is more than one subtree of the selected size, we select uniformly from among them.

Alternatively we can perform a kind of **homologous crossover**, if we turn on the following parameter:

```
pop.subpop.0.species.pipe.homologous = true
```

(or the default...)

```
gp.breed.size-fair.homologous = true
```

Homologous crossover is identical to size-fair crossover except for the final detail. Instead of selecting uniformly from among all subtrees of a chosen size, we instead select the one whose root is “closest” to the selected crossover point in the first parent. Here, distance between crossover points is defined as the depth at which their paths to the root begin to deviate from one another.

Size-fair and homologous crossover is due to Uday Kamath, a PhD student at GMU.

5.2.6 A Complete Example

Much of these initial parameters could have been entered simply by including the parameter file `ec/gp/koza/koza.params`. But we’ll go through it in detail. First some basic generational parameters:

```
# Threads and Seeds
evalthreads = 1
breedthreads = 1
seed.0 = time

# Checkpointing
checkpoint = false
checkpoint-modulo = 1
checkpoint-prefix = ec

# The basic setup
state = ec.simple.SimpleEvolutionState
finish = ec.simple.SimpleFinisher
exch = ec.simple.SimpleExchanger
breed = ec.simple.SimpleBreeder
eval = ec.simple.SimpleEvaluator
stat = ec.simple.SimpleStatistics
pop = ec.Population
pop.subpops = 1
pop.subpops.0 = ec.Subpopulation
pop.subpop.0.duplicate-retries = 0
pop.subpop.0.size = 1024
breed.elite.0 = 0
stat.file = $out.stat
quit-on-run-complete = true
```

Genetic programming typically doesn’t run very long, and (for the time being) require their own Initializer. We’ll also use `KozaFitness`. Following the *lil-gp* example, we’ll set the duplicate retries to 100:

```
init = ec.gp.GPInitializer
generations = 51
pop.subpop.0.species.fitness = ec.gp.koza.KozaFitness
pop.subpop.0.duplicate-retries = 100
```

For good measure, let’s attach `KozaShortStatistics` to the statistics chain. This isn’t standard in the `koza.params` file, but what the heck.

```

stat.num-children = 1
stat.child.0 = ec.gp.koza.KozaShortStatistics
stat.child.0.gather-full = true
stat.child.0.file = $out2.stat

```

Our initializer will work by using HalfBuilder to build trees. We define its parameters here:

```

# HalfBuilder
gp.koza.half.min-depth = 2
gp.koza.half.max-depth = 6
gp.koza.half.growp = 0.5

```

We begin by defining the tree constraints, node constraints, types, and function sets for the problem:

```

# Types
gp.type.a.size = 1
gp.type.a.0.name = nil
gp.type.s.size = 0

# Basic Function Set Parameters (more later)
gp.fs.size = 1
gp.fs.0 = ec.gp.GPFunctionSet
gp.fs.0.name = f0

# Tree Constraints
gp.tc.size = 1
gp.tc.0 = ec.gp.GPTreeConstraints
gp.tc.0.name = tc0
gp.tc.0.fset = f0
gp.tc.0.returns = nil
gp.tc.0.init = ec.gp.koza.HalfBuilder

# Node Constraints
gp.nc.size = 3

gp.nc.0 = ec.gp.GPNodeConstraints
gp.nc.0.name = nc0
gp.nc.0.returns = nil
gp.nc.0.size = 0

gp.nc.1 = ec.gp.GPNodeConstraints
gp.nc.1.name = nc1
gp.nc.1.returns = nil
gp.nc.1.size = 1
gp.nc.1.child.0 = nil

gp.nc.2 = ec.gp.GPNodeConstraints
gp.nc.2.name = nc2
gp.nc.2.returns = nil
gp.nc.2.size = 2
gp.nc.2.child.0 = nil
gp.nc.2.child.1 = nil

```

Now we define the GP elements of the Species and the Individual:

```

# Representation
pop.subpop.0.species = ec.gp.GPSpecies
pop.subpop.0.species.ind = ec.gp.GPIndividual
pop.subpop.0.species.ind.numtrees = 1
pop.subpop.0.species.ind.tree.0 = ec.gp.GPTree
pop.subpop.0.species.ind.tree.0.tc = tc0

```

Here's a basic GP breeding pipeline:

```

# Pipeline
pop.subpop.0.species.pipe = ec.breed.MultiBreedingPipeline
pop.subpop.0.species.pipe.generate-max = false
pop.subpop.0.species.pipe.num-sources = 2
pop.subpop.0.species.pipe.source.0 = ec.gp.koza.CrossoverPipeline
pop.subpop.0.species.pipe.source.0.probab = 0.9
pop.subpop.0.species.pipe.source.1 = ec.breed.ReproductionPipeline
pop.subpop.0.species.pipe.source.1.probab = 0.1

```

For no good reason, we'll define the selection methods, and various other parameters using the default parameter bases for CrossoverPipeline and ReproductionPipeline:

```

# Reproduction
breed.reproduce.source.0 = ec.select.TournamentSelection

# Crossover
gp.koza.xover.source.0 = ec.select.TournamentSelection
gp.koza.xover.source.1 = same
gp.koza.xover.ns.0 = ec.gp.koza.KozaNodeSelector
gp.koza.xover.ns.1 = same
gp.koza.xover.maxdepth = 17
gp.koza.xover.tries = 1

# Selection
select.tournament.size = 7

```

Since Crossover is using a node selector, let's define some parameters for that:

```

# Node Selectors
gp.koza.ns.terminals = 0.1
gp.koza.ns.nonterminals = 0.9
gp.koza.ns.root = 0.0

```

Let's presume that we have created the X, Y, Sin, Mul, and Sub methods described in Section 5.2.3. We'll now hook them up.

```

# Our Function Set
gp.fs.0 = ec.gp.GPFunctionSet
gp.fs.0.size = 5
gp.fs.0.func.0 = ec.app.myapp.X
gp.fs.0.func.0.nc = nc0
gp.fs.0.func.1 = ec.app.myapp.Y
gp.fs.0.func.1.nc = nc0
gp.fs.0.func.2 = ec.app.myapp.Mul
gp.fs.0.func.2.nc = nc2
gp.fs.0.func.3 = ec.app.myapp.Sub
gp.fs.0.func.3.nc = nc2
gp.fs.0.func.4 = ec.app.myapp.Sin
gp.fs.0.func.4.nc = nc1

```

Also we're using the MyProblem and MyData classes defined in Section 5.2.3 as our Problem. Even though we're not using ADFs (see Section 5.2.10), we need to define a few items here as well.

```

# Our Problem
eval.problem = ec.app.myapp.MyProblem
eval.problem.data = ec.app.myapp.MyData
gp.problem.stack = ec.gp.ADFStack
gp.adf-stack.context = ec.gp.ADFContext

```

Phew! That was a lot of parameters. Thankfully nearly all of them are already defined for you in `ec/gp/koza/koza.params`.

5.2.7 GPNodes in Depth

GPNode has a gazillion utility methods to assist various crossover, mutation, statistics, and tree-building operators in their tasks of making, breaking, printing, reading, writing and examining trees of GPNodes. Let's look at some of them here, and divvy up the rest in later sections where they're more appropriate.

First, the two abstract methods which you *must* override:

```

public String toString();
public abstract void eval(EvolutionState state, int thread, GPData input,
                        ADFStack stack, GPIndividual individual, Problem problem);

```

The first method prints out the node in a human-readable fashion, with no whitespace. Except for rare cases such as Ephemeral Random Constants (Section 5.2.9), this should be a single simple symbol like "cos" or "if-food-ahead". The second method we introduced in Section 5.2.3, of course.

Sanity Checking ECJ can double-check to make sure that the number of children to a given node, as claimed in the parameter file, is in fact proper. Other sanity checks might include that the children and parent are of the right GPType, and so on. The general method for doing this sanity check, which you can override if you like, is;

```

public void checkConstraints(EvolutionState state, int tree,
                            GPIndividual typicalIndividual, Parameter individualBase);

```

This method is called after the prototypical GPNode is loaded into a function set, and throws an error if the sanity check fails. The primary purpose of this method is to allow Automatically Defined Functions (Section 5.2.10) a chance to make sure that everything is working. But you can override this method to do some checking of your own as well. If you do so, be sure to call `super(...)`.

The default implementation of `checkConstraints(...)` just calls a simpler method which I suggest you implement instead. This method is:

```
public int expectedChildren();
```

You can override this method to return the expected number of children to this kind of node, as the most commonly-needed sanity check. If you override it and provide this value, `checkConstraints(...)` will by default call this method, then double-check for you that the number of children attached is indeed the expected number. By default, `expectedChildren()` returns:

```
public static final int CHILDREN_UNKNOWN;
```

This indicates to `checkConstraints(...)` that `expectedChildren()` is unimplemented and so `checkConstraints(...)` won't do anything at all by default. So you have three options here to help ECJ sanity-check that everything's okay:

- Override `expectedChildren()` to return the expected number of children to the node. The default implementation of `checkConstraints(...)` will compare this result against the actual number of children.
- Override `checkConstraints()` to do your own more sophisticated sanity-checking.
- Do nothing. ECJ will do no sanity checking and will rely on the correctness of your parameter file (this is often perfectly fine).

Next come some methods which are usually overridden by Ephemeral Random Constants but rarely by any other kind of `GPNODE` (the default implementation suffices):

ec.gp.GPNODE Methods

```
public String name()
```

Returns the name of the `GPNODE`. By default, this calls `toString()`.

```
public int hashCode()
```

Returns a hash code appropriate to your `GPNODE` (hash by value, not by address).

```
public boolean nodeEquals(GPNODE node)
```

Returns true if this method is identical to the given node.

```
public boolean nodeEquivalentTo(GPNODE node)
```

Returns true if the two nodes are the same "kind" of node—usually meaning they could have been cloned from the same prototype node. The default form of this function returns true if the two nodes are the same class, have the same length child array, and have the same constraints. Often `nodeEquals(...)` and `nodeEquivalentTo(...)` may return the same thing, but in Ephemeral Random Constants, they often return different values. For example, two ERCs that are the same class, and have the same constraints, may hold different values (2.34 vs. 3.14 say). These ERCs would be equivalent to one another but not equal to one another. You'd rarely need to override this method.

```
public String toStringForHumans()
```

Writes the node to a String in a fashion readable by humans. The default version simply calls `toString`.

```
public void resetNode(EvolutionState state, int thread)
```

Randomizes the node. Ephemeral Random Constants randomize their internal values; other `GPNODE`s typically do nothing.

Next, some test functions:

ec.gp.GPNODE Methods

```
public int atDepth()
```

Returns the depth of the node (the root is at depth 0).

```

public int depth()
    Returns the depth of the subtree rooted by the node (terminals have a subtree depth of 1).

public GPNodeParent rootParent()
    Returns the parent of the root of the tree in which the GPNode resides. Though the method returns a GPNodeParent, this returned object should always be some kind of GPTree.

public boolean contains(GPNode subnode)
    Returns true subnode exists somewhere within the subtree rooted by the GPNode.

public pathLength(int nodesearch)
    Returns the sum of all paths from all nodes in the GPNode's subtree to the GPNode itself. The nodesearch parameter allows us to restrict which nodes have paths included in the sum: only leaf nodes (terminals), non-leaf nodes (nonterminal), or all nodes:

        public static final int GPNode.NODESEARCH_ALL;
        public static final int GPNode.NODESEARCH_TERMINALS;
        public static final int GPNode.NODESEARCH_NONTERMINALS;

public int numNodes(int nodesearch)
    Returns the number of nodes in the subtree rooted by GPNode. The nodesearch parameter allows us to restrict which nodes are included in the total, using the constants above.

public int meanDepth(int nodesearch)
    Returns the path length divided by the number of nodes. The nodesearch parameter allows us to restrict which nodes are included in the total, using the constants above.

public GPNode nodeInPosition(int p, int nodesearch)
    Returns the pth node in the subtree rooted by the GPNode, using left-to-right depth-first search, and only considering those nodes specified by nodesearch, which can be one of:

        public static final int GPNode.NODESEARCH_ALL;
        public static final int GPNode.NODESEARCH_TERMINALS;
        public static final int GPNode.NODESEARCH_NONTERMINALS;

public java.util.Iterator iterator(int nodesearch)
    Returns a depth-first, left-to-right Iterator over all the nodes rooted by the GPNode. The nodesearch parameter allows us to restrict which nodes are iterated over, and may be one of:

        public static final int GPNode.NODESEARCH_ALL;
        public static final int GPNode.NODESEARCH_TERMINALS;
        public static final int GPNode.NODESEARCH_NONTERMINALS;

public java.util.Iterator iterator()
    Returns a depth-first, left-to-right Iterator over all the nodes rooted by the GPNode. Equivalent to iterator(GPNode.NODESEARCH_ALL).

```

Three methods permit even more flexibility in filtering exactly which GPNodes you want to consider, by using a `ec.gp.GPNodeGatherer` object. This object contains a single method, which you should override, and a single instance variable:

```

GPNode node; // used internally only
public abstract boolean test(GPNode thisNode);

```

You can ignore the variable: it's used by GPNode's recursion. As far as you are concerned, GPNodeGatherer provides a filter: override the `test(...)` method to specify whether certain GPNodes fit your needs. Armed with a GPNodeGatherer you've constructed, you can then call one of the two GPNode methods:

ec.gp.GPNode Methods

`public int numNodes(GPNodeGatherer gatherer)`
Returns the number of nodes (filtered by the GPNodeGatherer) in the subtree rooted by the GPNode.

`public GPNode nodeInPosition(int p, GPNodeGatherer gatherer)`
Returns the *p*th node in the subtree rooted by the GPNode, using left-to-right depth-first search, and only considering those nodes filtered by the provided GPNodeGatherer.

`public java.util.Iterator iterator(GPNodeGatherer gatherer)`
Returns a depth-first, left-to-right Iterator over all the nodes rooted by the GPNode, filtered by the GPNodeGatherer.

And now we come to `rigamarole` which should look familiar to you if you've trudged through the Vector chapter.

ec.gp.GPNode Methods

`public int printNodeForHumans(EvolutionState state, int log)`
Prints a node to a log in a fashion readable by humans. You don't want to override this method: it calls `toStringForHumans()` by default — override that instead.

`public int printNode(EvolutionState state, int log)`
Prints a node to a log in a fashion readable by humans and also parsable by `readNode(...)`. You don't want to override this method: it calls `toString()` by default — override that instead.

`public int printNode(EvolutionState state, PrintWriter writer)`
Prints a node to a writer in a fashion readable by humans and also parsable by `readNode(...)`. You don't want to override this method: it calls `toString()` by default — override that instead.

`public String toStringForError()`
Writes a node to a string in a fashion useful for error messages. The default writes out the name and the tree the node is in, which works fine.

`public GPNode readNode(DecodeReturn dret)`
Generates a GPNode from the DecodeReturn via a light clone: children and parents are not produced. The default version clones the node, then reads a string from the DecodeReturn. This string should match `toString()` exactly. If not, returns null to indicate an error. Otherwise returns the GPNode. This default implementation should be fine in most cases: though Ephemeral Random Constants (Section 5.2.9) require a different procedure.

`public void writeNode(EvolutionState state, DataOutput output) throws IOException`
Writes the node, but not any of its children or parents, out to *output*.

`public void readNode(EvolutionState state, DataInput input) throws IOException`
Reads a node from *input*. Children and parents are not produced.

Last are a host of different ways of cloning a GPNode or tree. In most cases the default implementations work just fine:

ec.gp.GPNode Methods

`public GPNode lightClone()`
Light-clones a GPNode, including its children array, but not any children or parents.

`public Object clone()`
Deep-clones a GPNode, except for its parent. All children are cloned as well.

```

public final GPNode cloneReplacing(GPNode newSubtree, GPNode oldSubtree)
    Deep-clones a GPNode, except that, if found within its cloned subtree, oldSubtree is replaced with a deep-cloned
    version of newSubtree.

public final GPNode cloneReplacing(GPNode[] newSubtrees, GPNode[] oldSubtrees)
    Deep-clones a GPNode, except that, if found within its cloned subtree, each of the oldSubtrees is replaced with a
    clone of the corresponding member of newSubtrees.

public final GPNode cloneReplacingNoSubclone(GPNode newSubtree, GPNode oldSubtree)
    Deep-clones a GPNode, except that, if found within its cloned subtree, oldSubtree is replaced with newSubtree (not
    a clone of newSubtree).

public final GPNode cloneReplacingAtomic(GPNode newNode, GPNode oldNode)
    Deep-clones a GPNode, except that, if found within its cloned subtree, oldNode is replaced with newNode (not a
    clone of newNode).

public final GPNode cloneReplacingAtomic(GPNode[] newNodes, GPNode[] oldNodes)
    Deep-clones a GPNode, except that, if found within its cloned subtree, each of the oldNodes is replaced with the
    corresponding member of newNodes (not a clone).

public final void replaceWith(GPNode newNode)
    Replaces the GPnode with newNode right where it lives in its GPtree.

```

These are the primary public methods. There are plenty of other public methods, but they're largely used internally and you'll rarely need them.

5.2.8 GPTrees and GPIndividuals in Depth

Unlike GPNode, there's nothing in a GPtree that you have to override or modify. It's pretty rare to subclass GPtree, though it's perfectly reasonable to do so. But there are a number of methods you should be aware of, many of which are probably very familiar by now. First, let's cover the three non-familiar ones:

ec.gp.GPtree Methods

```

public int treeNumber()
    Returns the position of the GPtree in its GPIndividual's trees[] array. This is an  $O(n)$  operation—it works by
    scanning through the array until it finds the GPtree. If the tree is not found (which would indicate an error), then
    GPtree.NO_TREENUM is returned.

public final void verify(EvolutionState state)
    An auxillary debugging method which verifies many features of the structure of the GPtree and all of its GPNodes.
    This method isn't called by ECJ but has proven useful in determining errors in GPtree construction by various
    tree building or breeding algorithms.

public void buildTree(EvolutionState state, int thread)
    Builds a tree and attaches it to the GPtree, displacing the original, using the tree-generation algorithm defined for
    its GPtreeConstraints. No specific tree size is requested.

```

Next come cloning and tests for removing duplicates:

ec.gp.GPtree Methods

```

public boolean treeEquals(GPtree tree)
    Returns true if the GPNodes which make up the GPtree are structured the same and equal in value to one another.
    Override this to provide more equality if necessary.

```

```

public int treeHashCode()
    Returns a hash code generated for the structure and makeup of the GPNodes in the GPTree. Override this to add
    additional hash information.

public GPTree lightClone()
    Performs a light clone on the GPTree: the GPNodes are not cloned but are instead the pointer to the root is simply
    copied.

public Object clone()
    Performs a deep clone on the GPTree, including all of its GPNodes but not its parent GPIndividual.

```

Last, the standard methods for printing and reading:

ec.gp.GPTree Methods

```

public void printTreeForHumans(EvolutionState state, int log)
    Prints the tree in a human-readable fashion to log.

public void printTree(EvolutionState state, int log)
    Prints to log the tree in a fashion readable both by humans and also by readTree(..., LineNumberReader). By default
    this uses the Code package (Section 2.2.3).

public void printTree(EvolutionState state, PrintWriter writer)
    Prints to writer the tree in a fashion readable both by humans and also by readTree(..., LineNumberReader). By
    default this uses the Code package.

public void readTree(EvolutionState state, LineNumberReader reader) throws IOException
    Reads a tree produced by printTree(...). By default, this uses the Code package (Section 2.2.3).

public void writeTree(EvolutionState state, DataOutput output) throws IOException
    Writes a tree to output in binary fashion such that it can be read by readTree(..., DataInput).

public void readTree(EvolutionState state, DataInput input) throws IOException
    Reads a tree from input in binary fashion that had been written by writeTree(...).

```

5.2.8.1 Pretty-Printing Trees

GPTrees have a particular gizmo that's not well known but is quite nice: you can print out GPTrees in one of (at present) four styles:

- Lisp (the default):

```
(* (+ x (- (% x x) (cos x))) (exp x))
```

- A style easily converted to C, C++, Java, or C#:

```
(x + ((x % x) - cos(x))) * exp(x)
```

To print out trees this way you'd use a parameter along these lines (notice the lower-case "c"):

```
pop.subpop.0.species.ind.tree.0.print-style = c
```

...or using the default parameter base:

```
gp.tree.print-style = c
```

Printing in C-style has two options. First, by default ECJ prints out two-child GPNodes as if they were operators "b a c" rather than as "a(b, c)". This is what's being done above. But if you're not using mathematical operators and would prefer to see 2-child GPNodes as functions, you can do it like this:

```
pop.subpop.0.species.ind.tree.0.c-operators = false
```

...or using the default parameter base:

```
gp.tree.c-operators = false
```

This results in the following:

```
*+(x, -(x, x), cos(x)), exp(x))
```

This doesn't seem useful for the example here (Symbolic Regression) but for other problems it's probably the right thing to do, particularly if all the GPNodes aren't operators.

Second, by default ECJ prints out zero-child GPNodes as constants, as in "a", rather than as zero-argument functions, as in "a()". If you'd prefer zero-argument functions, you might say:

```
pop.subpop.0.species.ind.tree.0.c-variables = false
```

...or using the default parameter base:

```
gp.tree.c-variables = false
```

This results in the following:

```
x() + ((x() % x()) - cos(x())) * exp(x())
```

Again, whether this will be useful to you is based on exactly what kind of problem you're emitting. ECJ does not at present have support for converting if-statements (such as the "if-food-ahead" node in Artificial Ant) into a brace format appropriate to C. But hopefully these options will help you get most of the ugly parsing work out the way.

- dot format: used by dot/GraphViz to produce high-quality trees and graphs. The code below produces the tree shown at left in Figure 5.5:

```
digraph g {
node [shape=rectangle];
n[label = "*"];
n0[label = "+"];
n00[label = "x"];
n0 -> n00;
n01[label = "-"];
n010[label = "%"];
n0100[label = "x"];
n010 -> n0100;
n0101[label = "x"];
n010 -> n0101;
n01 -> n010;
n011[label = "cos"];
n0110[label = "x"];
n011 -> n0110;
n01 -> n011;
n0 -> n01;
n -> n0;
```

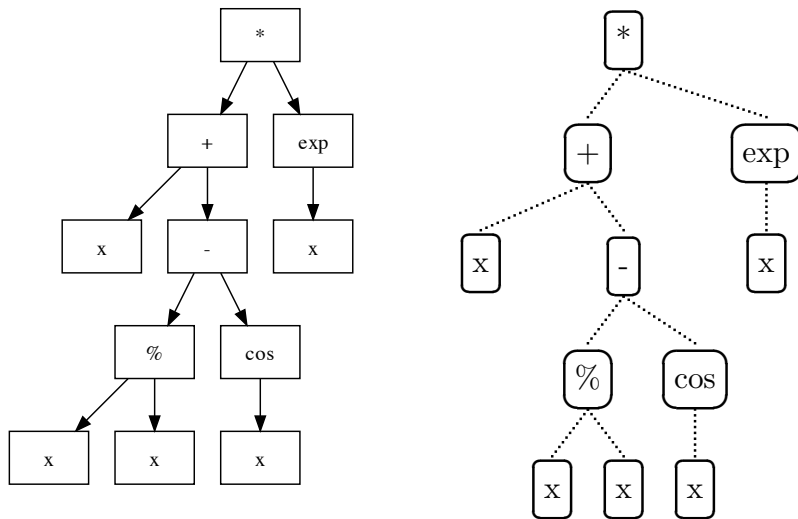

Figure 5.5 Auto-generated trees: in “.dot” format (left) and in \LaTeX format (right)

```
n1[label = "exp"];
n10[label = "x"];
n1 -> n10;
n -> n1;
}
```

To generate trees in .dot format, you’d say:

```
pop.subpop.0.species.ind.tree.0.print-style = dot
```

...or using the default parameter base:

```
gp.tree.print-style = dot
```

- \LaTeX format, which emits the following code:

```
\begin{bundle}{\gpbox{*}}\chunk{\begin{bundle}{\gpbox{+}}\chunk{\gpbox{x}}
\chunk{\begin{bundle}{\gpbox{-}}\chunk{\begin{bundle}{\gpbox{%}}
\chunk{\gpbox{x}}\chunk{\gpbox{x}}\end{bundle}}\chunk{\begin{bundle}
{\gpbox{cos}}\chunk{\gpbox{x}}\end{bundle}}\end{bundle}}\end{bundle}}
\chunk{\begin{bundle}{\gpbox{exp}}\chunk{\gpbox{x}}\end{bundle}}\end{bundle}
```

To generate trees in \LaTeX format, you’d say:

```
pop.subpop.0.species.ind.tree.0.print-style = latex
```

...or using the default parameter base:

```
gp.tree.print-style = latex
```

This code works with the \LaTeX `ecltree` and `fancybox` packages to produce a tree. Note that you'll have to replace the “%” with “\%” to make it legal \LaTeX . The code works with the following boilerplate to produce the tree shown at right in Figure 5.5.

```

\documentclass[]{article}
\usepackage{epic}      % required by ecltree and fancybox packages
\usepackage{ecltree}  % to draw the GP trees
\usepackage{fancybox} % required by \Ovalbox

\begin{document}

% minimum distance between nodes on the same line
\setlength{\GapWidth}{1em}

% draw with a thick dashed line, very nice looking
\thicklines \drawwith{\dottedline{2}}

% draw an oval and center it with the rule. You may want to fool with the
% rule values, though these seem to work quite well for me. If you make the
% rule smaller than the text height, then the GP nodes may not line up with
% each other horizontally quite right, so watch out.
\newcommand{\gpbox}[1]{\Ovalbox{#1\rule[-.7ex]{0ex}{2.7ex}}}

% And now the code. Note that % has been replaced with \%
\begin{bundle}{\gpbox{*}}\chunk{\begin{bundle}{\gpbox{+}}\chunk{\gpbox{x}}
\chunk{\begin{bundle}{\gpbox{-}}\chunk{\begin{bundle}{\gpbox{\%}}
\chunk{\gpbox{x}}\chunk{\gpbox{x}}\end{bundle}}\chunk{\begin{bundle}
{\gpbox{cos}}\chunk{\gpbox{x}}\end{bundle}}\end{bundle}}\end{bundle}}
\chunk{\begin{bundle}{\gpbox{exp}}\chunk{\gpbox{x}}\end{bundle}}\end{bundle}

% Finally end the document
\end{document}

```

5.2.8.2 GPIndividuals

Okay, there's not much in-depth here. `GPIndividual` implements all the standard `Individual` methods discussed in Section 3.2. Note that the `distanceTo(...)` method is *not* implemented. Two methods you might want to be aware of:

ec.gp.GPIndividual Methods

`public final void verify(EvolutionState state)`

An auxillary debugging method which verifies many features of the structure of the `GPIndividual` and ll of its `GPTrees` (and their `GPNodes`). This method isn't called by ECJ but has proven useful in determining errors in `GPTree` construction by various tree building or breeding algorithms.

`public long size()`

By default, returns the number of nodes in all the trees held by the `GPIndividual`.

5.2.9 Ephemeral Random Constants

An **Ephemeral Random Constant** or **ERC** [6] is a special `GPNode`, usually a terminal, which represents a constant such as 3.14159 or true or 724 or complex: $3.24 + 5i$ or “aegu”. Usually ERCs are used to add constants to programs which rely on math (such as Symbolic Regression).

An ERC needs to be able to do three things:

- Set itself to a random value when first created.
- Mutate to a new value when asked to do so.
- Stay fixed at that value all other times (as a constant).

In ECJ, ERCs are usually subclasses of `ec.gp.ERC`, an abstract superclass which provides basic functionality. For example, if we were building a subclass of ERC which represents a floating point numerical constant, we might add a single instance variable to hold its value:

```
package ec.app.myapp;
import ec.gp.*;
public class MyERC extends ERC {
    public double value;
    // other methods go here...
}
```

We'll also probably need to implement some or most of the following methods to modify, read, write, or compare the ERC.

```
public String name();
public boolean nodeEquals(GPNode node);
public int nodeHashCode();
public void resetNode(EvolutionState state, int thread);
public void mutateERC(EvolutionState state, int thread);
public String toStringForHumans();
public String encode();
public boolean decode(DecodeReturn ret);
public void readNode(EvolutionState state, DataInput input) throws IOException
public void writeNode(EvolutionState state, DataOutput output) throws IOException
public abstract void eval(EvolutionState state, int thread, GPData input,
                          ADFStack stack, GPIndividual individual, Problem problem);
```

Let's go through these in turn:

```
public String name();
```

This is not the default GPNode implementation. When an ERC prints itself out in various ways, it writes its name, then its value. By default the name is simply "ERC", and if you have only one ERC type, you don't have to override it. For example, an ERC printed out might be ERC[3.14159]. However if you have more than one class of ERCs, holding different kinds of values, you'll want to distinguish them both for humans and for ECJ to read back in again. To do this, override `name()` to return a unique symbol for each kind of ERC. For example, you might just return "ERC1" versus "ERC2", resulting in ERC1[3.14159] versus ERC2[921].

```
public boolean nodeEquals(GPNode node);
public int nodeHashCode();
```

Override the first method to test for equality with the second node: it's the same kind of ERC, the same class, has the same values, etc. Override the second method to provide a hash code for the ERC based on its type and the values it contains. By default you can avoid implementing this second method, and just implement the `encode()` method, discussed later. The default version of `nodeHashCode()` calls `encode()` and then hashes the String.

```
public void resetNode(EvolutionState state, int thread);
public void mutateERC(EvolutionState state, int thread);
```

Override the first method to entirely randomize the value of the ERC. Override the second method to mutate the value of the ERC when called to do so by the MutateERCPipeline. By default, mutateERC(...) just calls resetNode(...), which is probably not what you want. Instead the mutation will likely need to be a small deviation from the current value.

```
public String toStringForHumans();
public String encode();
public boolean decode(DecodeReturn ret);
public void readNode(EvolutionState state, DataInput input) throws IOException
public void writeNode(EvolutionState state, DataOutput output) throws IOException
```

As usual, override toStringForHumans() to provide a pretty version of the ERC for human consumption, used by GPNode's printer functions. The default version just calls toString(). You probably want to write something prettier. The encode() and decode(...) methods are supposed to use the Code package (Section 2.2.3) to encode and decode the ERC in a reasonable fashion.

Finally, the readNode(...) and writeNode(...) methods, as usual, read and write the ERC in binary fashion. You only need to implement these methods if you're planning on writing over the network (such as using distributed evaluation or island models). But they're easy so why not? And of course, there's the method to actually execute the ERC as code. This typically returns the ERC's internal value (it's a constant after all):

```
public abstract void eval(EvolutionState state, int thread, GPData input,
                        ADFStack stack, GPIndividual individual, Problem problem);
```

Note that ERCs by default override the expectedChildren() method to return 0 (they are usually terminals). If for some reason your ERC is *not* a terminal, you'll want to override this method to return the right number of children.

Example Let's create an ERC and add it to our existing example from Section 5.2.6. We'll make an ERC which represents constants between 0.0 and 1.0, not including 1.0. Our mutator will add a little Gaussian noise to the node. Here's a full class:

```
package ec.app.myapp;
import ec.gp.*;
public class MyERC extends ERC {
    public double value;
    public String toStringForHumans() { return "" + value; }
    public String encode() { return Code.encode(value); }

    public boolean decode(DecodeReturn ret) {
        int pos = dret.pos;
        String data = dret.data;
        Code.decode(dret);
        if (dret.type != DecodeReturn.T_DOUBLE) // uh oh! Restore and signal error.
            { dret.data = data; dret.pos = pos; return false; }
        value = dret.d
        return true;
    }

    public boolean nodeEquals(GPNode node)
        { return (node.getClass() == this.getClass() && ((MyERC)node).value == value); }

    public void readNode(EvolutionState state, DataInput input) throws IOException
        { value = dataInput.readDouble(); }

    public void writeNode(EvolutionState state, DataOutput output) throws IOException
```

```

    { dataOutput.writeDouble(value); }

public void resetNode(EvolutionState state, int thread)
    { val = state.random[thread].nextDouble(); }

public void mutateNode(EvolutionState state, int thread) {
    double v;
    do v = value + state.random[thread].nextGaussian() * 0.01;
    while( v < 0.0 || v >= 1.0 );
    value = v;
}

public void eval(EvolutionState state, int thread, GPData input, ADFStack stack,
                GPIndividual individual, Problem Problem)
    { ((MyData)data).val = value; }
}

```

Now let's set up the parameters to use it. We'll change the function set. Our ERC is a terminal so it takes no arguments: we'll use nc0 as its constraints.

```

# Our Function Set
gp.fs.0 = ec.gp.GPFunctionSet
gp.fs.0.size = 6
gp.fs.0.func.0 = ec.app.myapp.X
gp.fs.0.func.0.nc = nc0
gp.fs.0.func.1 = ec.app.myapp.Y
gp.fs.0.func.1.nc = nc0
gp.fs.0.func.2 = ec.app.myapp.Mul
gp.fs.0.func.2.nc = nc2
gp.fs.0.func.3 = ec.app.myapp.Sub
gp.fs.0.func.3.nc = nc2
gp.fs.0.func.4 = ec.app.myapp.Sin
gp.fs.0.func.4.nc = nc1
gp.fs.0.func.5 = ec.app.myapp.MyERC
gp.fs.0.func.5.nc = nc0

```

... and we're done.

5.2.10 Automatically Defined Functions and Macros

Automatically Defined Functions (ADFs) [7] are a standard way of creating some modularism in Genetic Programming. They define multiple trees in the GPIndividual and essentially define a function calling structure where certain trees can call other trees as subfunctions. ADFs are the primary reason why GPIndividual has multiple GPTrees.

The simplest kind of ADF is found in Figure 5.6. Here each ADF function is a terminal, and when it is evaluated, it simply evaluates the corresponding ADF tree, then returns the tree's return value. The ADF function is a GPNode, an instance of ec.gp.ADF. It's very rare to further specialize this class. Notice that calling is nested — an ADF can call another ADF and so on. However it's not very common to have *recursive* calls because you'll need to construct some kind of stopping base-case criterion to avoid infinite recursive loops.

ADFs add a two more parameters to the standard GPNode suite. Let's say we're adding a zero-argument ADF. Beyond the node constraints, we also need to specify which tree will be called when the ADF is executed; and also a simple name for the ADF to distinguish it from other ADFs and GPNodes. Ideally this name should only have lowercase letters, numbers, and hyphens (that is, "Lisp-style"):

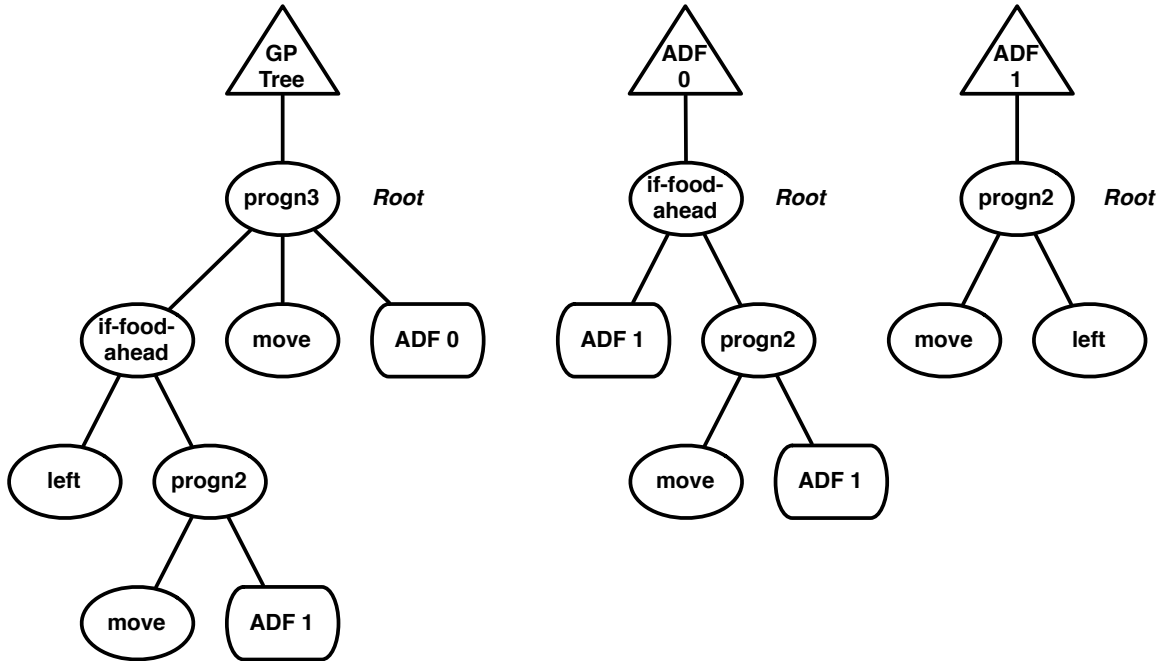

Figure 5.6 A GPIndividual with two no-argument (terminal) ADFs. The primary GP Tree has functions in its function set that can call the other two trees; in turn the ADF 1 tree has a function in its function set that can call the ADF 2 tree. The return values of the various ADF trees become the return values of their respective calling functions.

```
gp.fs.0.func.5 = ec.gp.ADF
gp.fs.0.func.5.nc = nc0
gp.fs.0.func.5.tree = 1
gp.fs.0.func.5.name = ADF0
```

It's traditional that the first tree be called ADF0, the second ADF1, and so on. Since typically the first GP Tree in the array is the "main" tree, and the second tree is ADF0, this means that ADF0's associated tree number is usually 1, and ADF1's associated tree number is usually 2. If you don't specify a name, ECJ will maintain this tradition by setting the name to "ADF" + (tree number - 1), which is usually right anyway. It'll also issue a warning.

The name of the ADF (in this case "ADF1") and its associated GP tree (in this case, tree 1) are stored in the ec.gp.ADF class like this:

```
public int associatedTree;
public String name;
```

The name() method returns the value of the name variable.

ADFArguments override the checkConstraints(...) method to do a lot of custom advanced checking. If you override this, be sure to call super().

We'll show how to set up the ADF tree itself in the Example below.

ADFs can also have arguments to the functions. In Figure 5.7, we have an ADF with two arguments. The way this works is as follows: when an ADF function is called, we first evaluate its children, then hold their return values in storage. We then call the corresponding ADF tree. In that tree there may be one or more special terminal GPNodes, two different kinds of instances of ec.gp.ADFArgument. One group of instances, when evaluated, will return the value of the first child. The second group return the value of the second child. This enables the ADF tree to use arguments in its "function call" so to speak.

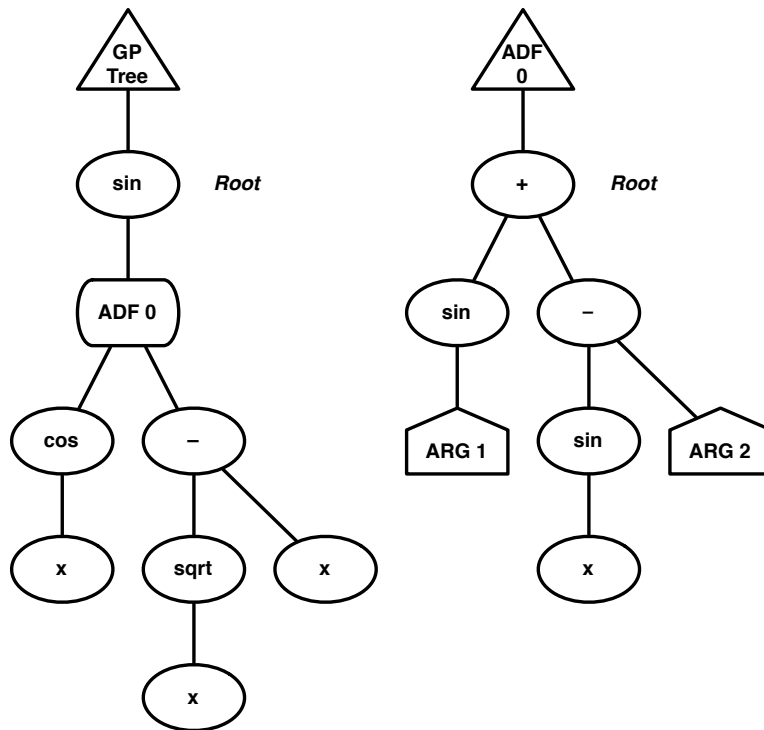

Figure 5.7 A GPIndividual with one 2-argument ADF. The primary GP Tree has a function in its function set that can call the ADF tree. This function first evaluates its children, then executes the ADF tree. In the ADF tree there are two terminal functions (ARG 1 and ARG 2) which, when evaluated, return the values of the two children respectively. The return value of the ADF tree becomes the return value of the ADF function.

ADFAArguments add one additional parameter: the child number associated with the argument. For example:

```
gp.fs.1.func.6 = ec.gp.ADFArgument
gp.fs.1.func.6.nc = nc0
gp.fs.1.func.6.arg = 0
gp.fs.1.func.6.name = ARG0
```

If you don't specify a name, ECJ will set the name to "ARG" + arg number, which is usually right anyway. It'll also issue a warning.

The ADFAArgument's name and argument number are stored in the ec.gp.ADFArgument class as:

```
public int argument;
public String name;
```

Again, the name() method returns the value of the name variable.

ADFAArguments are always terminals, and so they override the expectedChildren() method to return 0.

ECJ also supports **Automatically-Defined Macros** (or ADMs), described in [23]. These differ from ADFs only in when the children are evaluated. When an ADM node is evaluated, its children are not evaluated first; rather the ADM immediately calls its associated tree. When an argument node in that tree (again, a terminal) is evaluated, we teleport back to the associated child and evaluate it right then and there, then return its value. Note that this means that children may never be evaluated; or can be evaluated multiple times, as shown in Figure 5.8.

ADMs are just like ADFs in their parameters:

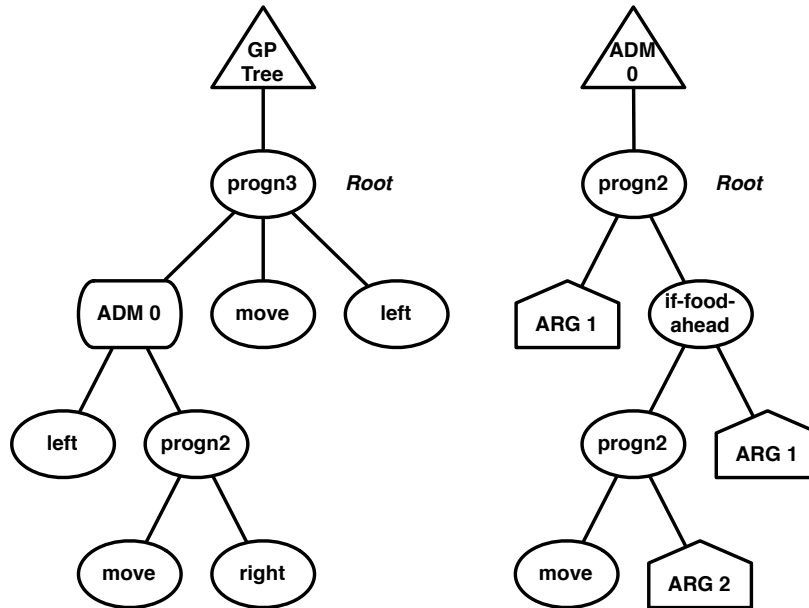

Figure 5.8 A GPIndividual with one 2-argument ADM. The primary GP Tree has a function in its function set that can call the ADM tree. This function delays the evaluation of its children, and immediately executes the ADM tree. In the ADM tree there are two terminal functions (ARG 1 and ARG 2) which, when evaluated, evaluate (or, as necessary, re-evaluate) the original children to the ADM function and then return their values. Notice that in this example child # 1 may be evaluated *twice*, and child #2, depending on whether there's food ahead, may be *never evaluated*.

```
gp.fs.0.func.6 = ec.gp.ADM
gp.fs.0.func.6.nc = nc2
gp.fs.0.func.6.tree = 1
# This will be called "ADM1"
gp.fs.0.func.6.name = ADM1
```

If an ADF or ADM tree has arguments, it probably will require its own separate GPTreeConstraints, because it needs to have its own GPFunctionSet with those arguments defined. See the Example below.

5.2.10.1 About ADF Stacks

ADFs and ADMs are a bit complex. To do their magic, they need a special object called an `ec.gp.ADFStack`. This is actually two stacks of `ec.gp.ADFContext` objects which store the location and current return values of various children. These classes are almost never overridden: here's the standard (default) parameters for them:

```
gp.problem.stack = ec.gp.ADFStack
gp.adf-stack.context = ec.gp.ADFContext
```

You *could* have defined it this way..

```
eval.problem.stack = ec.gp.ADFStack
eval.problem.stack.context = ec.gp.ADFContext
```

... but there are advantages in using the default parameters, particularly when getting to Grammatical Evolution (Section 5.3).

Example ADFs and ADMs are fairly straightforward to implement but they can require a fair number of parameters. Continuing with the example in started in Section 5.2.6 and extended in Section 5.2.9, let's add a 2-argument ADF to the individual. This will require adding a second GPTree and its own GPTreeConstraints.

Let's begin by modifying the GPFunctionSet of the original tree to include this ADF:

```
# Our Function Set
gp.fs.0 = ec.gp.GPFunctionSet
gp.fs.0.size = 7
gp.fs.0.func.0 = ec.app.myapp.X
gp.fs.0.func.0.nc = nc0
gp.fs.0.func.1 = ec.app.myapp.Y
gp.fs.0.func.1.nc = nc0
gp.fs.0.func.2 = ec.app.myapp.Mul
gp.fs.0.func.2.nc = nc2
gp.fs.0.func.3 = ec.app.myapp.Sub
gp.fs.0.func.3.nc = nc2
gp.fs.0.func.4 = ec.app.myapp.Sin
gp.fs.0.func.4.nc = nc1
gp.fs.0.func.5 = ec.app.myapp.MyERC
gp.fs.0.func.5.nc = nc0
gp.fs.0.func.6 = ec.gp.ADF
gp.fs.0.func.6.nc = nc2
gp.fs.0.func.6.tree = 1
gp.fs.0.func.6.name = ADF1
```

Let's create a second function set for our second (ADF) tree. This set will have all the same functions as the main tree, except for the ADF function (we don't want to call ourselves recursively!) Instead we'll add two ADFArgument nodes to represent the two children.

```

gp.fs.size = 2

# Our Second Function Set
gp.fs.1 = ec.gp.GPFunctionSet
gp.fs.1.name = f1
gp.fs.1.size = 8
gp.fs.1.func.0 = ec.app.myapp.X
gp.fs.1.func.0.nc = nc0
gp.fs.1.func.1 = ec.app.myapp.Y
gp.fs.1.func.1.nc = nc0
gp.fs.1.func.2 = ec.app.myapp.Mul
gp.fs.1.func.2.nc = nc2
gp.fs.1.func.3 = ec.app.myapp.Sub
gp.fs.1.func.3.nc = nc2
gp.fs.1.func.4 = ec.app.myapp.Sin
gp.fs.1.func.4.nc = nc1
gp.fs.1.func.5 = ec.app.myapp.MyERC
gp.fs.1.func.5.nc = nc0
gp.fs.1.func.6 = ec.gp.ADFArgument
gp.fs.1.func.6.nc = nc0
gp.fs.1.func.6.arg = 0
gp.fs.1.func.6.name = ARGO
gp.fs.1.func.7 = ec.gp.ADFArgument
gp.fs.1.func.7.nc = nc0
gp.fs.1.func.7.arg = 1
gp.fs.1.func.7.name = ARG1

```

Now we create a new GPTreeConstraints which uses this function set:

```

gp.tc.size = 2

# Our Second Tree Constraints
gp.tc.1 = ec.gp.GPTreeConstraints
gp.tc.1.name = tc1
gp.tc.1.fset = f1
gp.tc.1.returns = nil
gp.tc.1.init = ec.gp.koza.HalfBuilder

```

Next we add the second tree to the GPIndividual:

```

pop.subpop.0.species.ind.numtrees = 2
pop.subpop.0.species.ind.tree.1 = ec.gp.GPTree
pop.subpop.0.species.ind.tree.1.tc = tc1

```

The ADF stack and ADF context were already defined in the previous examples, but we'll do it again here for clarity:

```

gp.problem.stack = ec.gp.ADFStack
gp.adf-stack.context = ec.gp.ADFContext

```

...and we're done!

An important note: because the main GP Tree and the ADF have different function sets and thus different GPTreeConstraints, standard GP Crossover (see Section 5.2.5) won't cross over the ADF tree with a main tree of some other individual or vice versa. But if, for example, your GPIndividual had two ADF trees that

had the *same* GPTreeConstraints, they could get crossed over with arbitrary other ADF trees in another GPIndividuals.

5.2.11 Strongly Typed Genetic Programming

Sometimes it's useful to constrain which GPNodes may serve as children of other GPNodes, or the root of the GPTree. For example, consider a GPNode called (*if test then else*). This node evaluates *test*, and based on its result (true or false) it either evaluates and returns *then* or *else*. Let's presume that *then* and *else* (and *if*) return doubles. On the other hand, *test* is intended to return a boolean. So you'll need to have some GPNodes in your function set which return doubles and others which return booleans; the (*if ...*) node itself returns a double.

The problem is not that you have nodes which return different values — this is easily handled by hacking your GPData object. The problem is that you now have constraints on valid tree structures: you can't plug a node which returns a double (say, (*sin ...*)) into the *test* slot of your (*if ...*) node, which is expecting a boolean.⁶ This is where strong typing comes in.

ECJ's typing system is simple but sufficient for many common uses. It's not as sophisticated as a full polymorphic typing system but it also doesn't have the hair-raising complexity that such a system requires. ECJ is complex enough as it is thank you very much!

ECJ's system is based on **type objects**, subclasses of the abstract superclass `ec.gp.GPType`, and nodes are allowed to connect as parent and child if their corresponding type objects are **type compatible**. ECJ's type objects of two kinds: atomic types and set types. An atomic type is just a single object (in fact, it's theoretically just a symbol, or in some sense, an integer). A set type is a set of atomic types. Type compatibility is as follows:

- Two atomic types are compatible if they are the same.
- A set type is compatible with an atomic type if it contains the atomic type in its set.
- Two set types are compatible if their intersection is nonempty.

Every GPNode is assigned a type object to represent the "return type" of the GPNode. Furthermore every nonterminal GPNode is assigned a type object for each of its children: this is called the "child type" or "argument type" or that particular child slot. Last, the GPTree itself is assigned "root type": a type for the root of the tree. Each GPTree in a GPIndividual can have a different root type. Here's what must be true about any given GPTree.

- For any parent and child in a tree, with the child in slot *C*, the return type of the child must be compatible with the child type of the parent for slot *C*.
- The return type of the root GPNode must be compatible with the GPTree's root type. This ensures that the tree is returning

You can see an example of a GPTree with type constraints listed in Figure 5.9.

Every GPNodeBuilder and GP Breeding Pipeline must maintain the constraints guaranteed by typing. The issue is guaranteeing that if you replace one GPNode with another, that the second GPNode will be legal. This is done primarily with the following two utility functions:

ec.gp.GPNode Methods

`public GPType parentType(GPInitializer initializer)`

If the GPNode's parent is another GPNode, this returns the type of the parent's child slot presently filled by the GPNode. If the GPNode's parent is a GPTree, this returns the type of the tree's root.

⁶Well, you *could* if you assumed that 0.0 was false and anything else was true. But this is a hack. The right way to do it is to constrain things properly

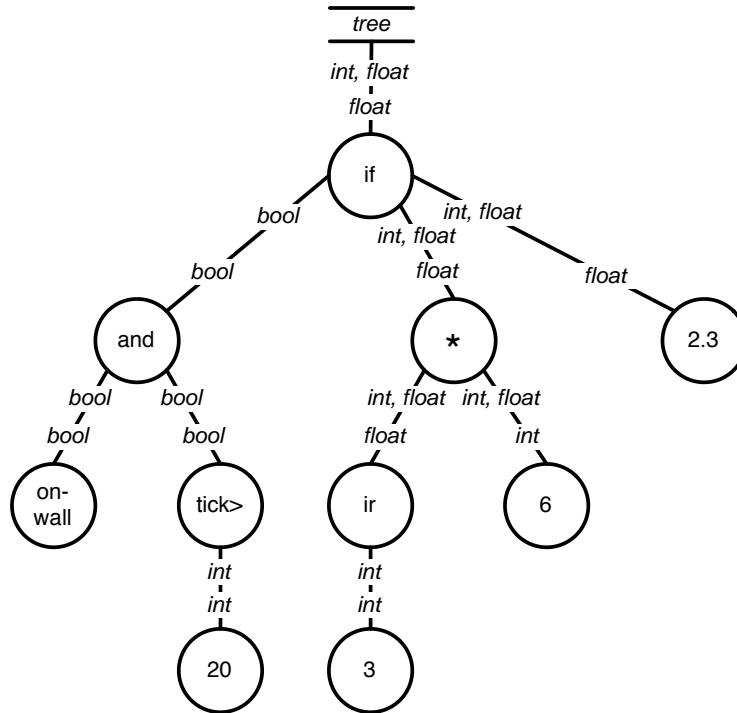

Figure 5.9 A typed genetic programming parse tree. Each edge is labeled with two types. The “lower” type is the return type of the child node. The “upper” type is the type of the argument slot of the parent. For the child to fit into that particular argument slot, the types must be compatible. Types of the form “int, float” are set types. All others are atomic types. Note that the root of the tree plugs into a particular slot of the “tree” object (ec.gp.GPTree), which itself has a slot type. A repeat of Figure 1.4.

```
public final boolean swapCompatibleWith(GPInitializer initializer, GPNode node)
    Returns true swapping the GPNode into the slot presently occupied by node is acceptable, type-wise.
```

Before you can assign types, you’ll need to define them. Each type is given a unique symbol. As an example, let’s begin by creating two atomic types, called (uninterestingly) “boolean” and “nil” (we say “nil” instead of “double” so we don’t have to redefine the GPTreeConstraints and GPNodeConstraints we defined earlier, which all use “nil” as their types). We’d say:

```
gp.type.a.size = 2
gp.type.a.0.name = boolean
gp.type.a.1.name = nil
```

We might also define a set type or two. For fun, let’s create a set type which contains both booleans and doubles. We’ll also have to stipulate the atomic types encompassed by the set type:

```
gp.type.s.size = 1
gp.type.s.0.name = boolean-or-nil
gp.type.s.0.size = 2
gp.type.s.0.member.0 = boolean
gp.type.s.0.member.1 = nil
```

What’s the point of set types, you might ask. Why not just atomic types? Set types are particularly useful for describing situations where a given GPNode can adapt to several different kinds of children in a given

slot. This is particularly useful for simulating notions of subtyping or subclassing. For example, a GPNode like (sin ...) might declare that its child can either be an “integer” or a “double”, by having its child type defined as a set type of “number” which encapsulates both integers and doubles.

What this typing facility *cannot* do is dynamically change types as necessary. For example, you cannot say that a GPNode like (+) returns a double if either of its children is of type double, but if both of its children are of type integer, then it returns an integer.

You are also restricted to a finite number of types. For example, consider a GPNode called (matrix-multiply) which takes two children which return matrices. You cannot say that if the left child is an $M \times N$ matrix, and your right child is an $N \times P$ matrix, that the return type will be an $M \times P$ matrix. This is partly because you can’t define dynamic typing, but it’s also because M , N , and P can be any of an infinite number of numbers, resulting in an infinite number of types: specifying an infinite number of types would be hard on your fingers. There exist polymorphic typing systems for genetic programming but they’re fairly bleeding-edge. If you need things like this, I suggest instead to look at Grammatical Evolution (Section 5.3).

Example Let’s add some typing to the example we started in Section 5.2.6 and continued in Sections 5.2.9 and 5.2.10. We’ll add a boolean type as before, and a few functions which rely on it.

First the boolean type:

```
gp.type.a.size = 2
gp.type.a.0.name = boolean
gp.type.a.1.name = nil
gp.type.s.size = 1
gp.type.s.0.name = boolean-or-nil
gp.type.s.0.size = 2
gp.type.s.0.member.0 = boolean
gp.type.s.0.member.1 = nil
```

Next we need to say what kinds of nodes are permitted as the root of the tree. We do this by specifying the tree’s return type. For a node to be permitted as the root of the tree, it must have a return type compatible with this tree return type. Let’s say that we want our tree to only have root nodes which have a return type of nil (no boolean allowed):

```
gp.tc.size = 1
gp.tc.0 = ec.gp.GPTreeConstraints
gp.tc.0.name = tc0
gp.tc.0.fset = f0

# Here we define the return type of this GPTreeConstraints
gp.tc.0.returns = nil
```

As it so happens, this is what we already have by default, so putting it all here is a bit redundant.

Next we’ll need to modify the node constraints for each GPNode, so we specify the return type of each of our nodes and also the expected child types of their child slots. For the node constraints, let’s add three new GPNodeConstraints:

- A function which returns a double (nil), has three children, and the first child needs to be a boolean. The other two children are nil. This would be for things like the (if) node.
- A function which takes two booleans and returns a boolean. This would be for functions like (nand).
- A function which takes two doubles and returns a boolean. This would be for functions like (>).

These three new GPNodeConstraints would be:

```

gp.nc.size = 6

# ... first come the original node constraints, then these:

# Example: (if ... ..)
gp.nc.3 = ec.gp.GPNodeConstraints
gp.nc.3.name = nc3
gp.nc.3.returns = nil
gp.nc.3.size = 3
gp.nc.3.child.0 = boolean
gp.nc.3.child.1 = nil
gp.nc.3.child.2 = nil

# Example: (nand ... ..)
gp.nc.4 = ec.gp.GPNodeConstraints
gp.nc.4.name = nc2
gp.nc.4.returns = boolean
gp.nc.4.size = 2
gp.nc.4.child.0 = boolean
gp.nc.4.child.1 = boolean

# Example: (> ... ..)
gp.nc.5 = ec.gp.GPNodeConstraints
gp.nc.5.name = nc2
gp.nc.5.returns = boolean
gp.nc.5.size = 2
gp.nc.5.child.0 = nil
gp.nc.5.child.1 = nil

```

Recall that our GPData looks like this:

```

package ec.app.myapp;
import ec.gp.*;
public class MyData extends GPData
{
    public double val;
    public GPData copyTo(GPData other)
        { ((MyData)other).val = val; return other; }
}

```

We could modify this to include a boolean data type as well, but we'll just use the val variable to store both boolean and real-valued data. Before you go about that, re-read Section 5.2.3.1 (on GPData) and its discussion about clone() and copyTo(...).

Now let's define our three new GPNodes. First our If-statement:

```

package ec.app.myapp;
import ec.*;
import ec.gp.*;
public class If extends GPNode {
    public String toString() { return "if" };
    public void eval(EvolutionState state, int thread, GPData input,
        ADFStack stack, GPIndividual individual, GPPProblem problem) {
        MyData data = (MyData) input;
        children[0].eval(state, thread, data, stack, individual, prob);
        if (data.val != 0.0) // true
            children[1].eval(state, thread, data, stack, individual, prob);
        else
            children[2].eval(state, thread, data, stack, individual, prob);
        // the result be stored in data
    }
}

```

Next, the nand node:

```

package ec.app.myapp;
import ec.*;
import ec.gp.*;
public class Nand extends GPNode {
    public String toString() { return "nand" };
    public void eval(EvolutionState state, int thread, GPData input,
        ADFStack stack, GPIndividual individual, GPPProblem problem) {
        MyData data = (MyData) input;
        children[0].eval(state, thread, data, stack, individual, prob);
        boolean left = (data.val != 0.0);
        children[1].eval(state, thread, data, stack, individual, prob);
        boolean right = (data.val != 0.0);
        data.val = !(left && right) ? 1.0 : 0.0;
    }
}

```

Next, the > node:

```

package ec.app.myapp;
import ec.*;
import ec.gp.*;
public class GreaterThan extends GPNode {
    public String toString() { return ">" };
    public void eval(EvolutionState state, int thread, GPData input,
        ADFStack stack, GPIndividual individual, GPPProblem problem) {
        MyData data = (MyData) input;
        children[0].eval(state, thread, data, stack, individual, prob);
        double left = data.val;
        children[1].eval(state, thread, data, stack, individual, prob);
        double right = data.val;
        data.val = (left > right) ? 1.0 : 0.0;
    }
}

```

Notice that these functions hijack the double value to store boolean information. This is okay because we *know* that the recipient of this information will understand it. How do we know? Because the typing constraints have made it impossible to be otherwise.

So let's add these functions to the function set of our main GP Tree:

```
# Our Main Tree Function Set
gp.fs.0 = ec.gp.GPFunctionSet
gp.fs.0.size = 10
gp.fs.0.func.0 = ec.app.myapp.X
gp.fs.0.func.0.nc = nc0
gp.fs.0.func.1 = ec.app.myapp.Y
gp.fs.0.func.1.nc = nc0
gp.fs.0.func.2 = ec.app.myapp.Mul
gp.fs.0.func.2.nc = nc2
gp.fs.0.func.3 = ec.app.myapp.Sub
gp.fs.0.func.3.nc = nc2
gp.fs.0.func.4 = ec.app.myapp.Sin
gp.fs.0.func.4.nc = nc1
gp.fs.0.func.5 = ec.app.myapp.MyERC
gp.fs.0.func.5.nc = nc0
gp.fs.0.func.6 = ec.gp.ADF
gp.fs.0.func.6.nc = nc2
gp.fs.0.func.6.tree = 1
gp.fs.0.func.6.name = ADF1
gp.fs.0.func.7 = ec.app.myapp.If
gp.fs.0.func.7.nc = nc3
gp.fs.0.func.8 = ec.app.myapp.Nand
gp.fs.0.func.8.nc = nc4
gp.fs.0.func.9 = ec.app.myapp.GreaterThan
gp.fs.0.func.9.nc = nc5
```

...and we're done!

Mixing ADF and ADMs and Typed GP A quick note. The return type of an ADF node must match the root type of its corresponding ADF tree. Additionally, the child type of a certain slot in an ADF node must match the return type of the corresponding ADFArgument.

5.2.11.1 Inside GPTypes

If you want to create a GPNodeBuilder or a GP Breeding Pipeline, you ought to go in more detail about GPTypes.

ec.gp.GPType is an abstract superclass of ec.gp.GPAtomicType and ec.gp.GPSetType, which define the atomic and set types respectively. The two basic data elements in a GPType are:

```
public String name;
public int type;
```

The first variable, like GPFunctionSet, GPTreeConstraints, and GPNodeConstraints, holds the name of the type (as defined in the parameters). The second variable holds a uniquely-assigned integer for this type. The important feature for types is to determine whether they are **type-compatible** with one another. The compatibility function is this:

ec.gp.GPType Methods

```
public boolean compatibleWith(GPInitializer initializer, GPType type)
```

Returns true if the return type of this GPNode is type-compatible with the given type.

GPAAtomicTypes are simple: they are compatible with one another if their type integer is the same. A GPSetType instead is a set of GPAAtomicTypes, stored in different ways for query convenience:

```
public Hashtable types_h;  
public int[] types_packed;  
public boolean[] types_sparse;
```

The first is the GPAAtomicTypes in the set stored in a Hashtable. The second is an array of the GPAAtomicTypes. And the third is an array of booleans, one for each GPAAtomicType number, which is true if that GPAAtomicType is a member of the set.

A GPSetType is compatible with a GPAAtomicType if the GPSetType contains the GPAAtomicType as an element. Two GPSetTypes are compatible with one another if their intersection is nonempty.

5.2.12 Parsimony Pressure (The ec.parsimony Package)

Genetic programming has a serious bloat problem: as evolution progresses, the size of the trees inside the population tend to grow without bound. This is a problem that exists for various arbitrary-length representations (lists, graphs, rulsets, etc.) but genetic programming has studied it the most.

The most common simple way of keeping trees down is to make it illegal to produce a tree larger than a certain depth. For example, Koza's standard rules, adhered to by the basic parameters in ECJ, stipulate that crossover and mutation operators may not produce a child which is deeper than 17 nodes [6], for example:

```
gp.koza.xover.tries = 1  
gp.koza.xover.maxdepth = 17
```

Here if the crossover operation produces a child greater than 17, it is not forwarded on; but rather its (presumably smaller) parent is forwarded on in its stead. This is a fairly crude approach, but it's fairly effective. Another approach — which can be done at the same time — is to modify the selection operator to favor smaller individuals. This notion is called **parsimony pressure**.

In the ec.parsimony package, ECJ has several SelectionMethods which select both based on fitness and on size (smaller size being preferred). These methods compute size based on GPNode's size() function. Many of these selection methods were compared and discussed at length in [13]. Here they are:

- ec.parsimony.LexicographicTournamentSelection is a straightforward TournamentSelection operator, except that the fitter Individual is preferred (as usual), but when both Individuals are the same fitness, the smaller Individual is preferred. Parameters for this operator are basically the same as for TournamentSelection.

Let us presume that the SelectionMethod is the first source of the pipeline of Subpopulation 0. Then the basic parameters are the same as in TournamentSelection:

```
pop.subpop.0.species.pipe.source.0 = ec.parsimony.LexicographicTournamentSelection  
pop.subpop.0.species.pipe.source.0.size = 7  
pop.subpop.0.species.pipe.source.0.pick-worst = false
```

Or using the default parameters:

```
pop.subpop.0.species.pipe.source.0 = ec.parsimony.LexicographicTournamentSelection  
select.lexicographic-tournament.size = 7  
select.lexicographic-tournament.pick-worst = false
```

The problem with this method is that bloat control only comes into effect for problems where lots of fitness ties occur. This problem lead us to two modifications of the basic idea:

- ec.parsimony.BucketTournamentSelection is like LexicographicTournamentSelection, except that first individuals are placed into N classes ("buckets") based on fitness. The subpopulation is first sorted by

fitness. Then the bottom $\frac{\text{subpopulation size}}{N}$ individuals are placed in the worst bucket, plus any individuals remaining in the subpopulation with the same fitness as the best individual in that bucket. Next the bottom remaining $\frac{\text{subpopulation size}}{N}$ are placed in the second worst bucket, plus any individuals remaining in the population with the same fitness as the best individual in that bucket. This continues until all the individuals are exhausted. BucketTournamentSelection then works like LexicographicTournamentSelection except that instead of comparing based on fitness, it compares based on the bucket the individual is in. The number of buckets is defined by num-buckets:

```
pop.subpop.0.species.pipe.source.0 = ec.parsimony.BucketTournamentSelection
pop.subpop.0.species.pipe.source.0.size = 7
pop.subpop.0.species.pipe.source.0.pick-worst = false
pop.subpop.0.species.pipe.source.0.num-buckets = 10
```

Or using the default parameters:

```
pop.subpop.0.species.pipe.source.0 = ec.parsimony.BucketTournamentSelection
select.bucket-tournament.size = 7
select.bucket-tournament.pick-worst = false
select.bucket-tournament.num-buckets = 10
```

- ec.parsimony.ProportionalTournamentSelection is like TournamentSelection, except that it *either* selects based on fitness *or* selects based on size. It determines which one to do by flipping a coin of a certain probability that *fitness* will be used. The parameters are:

```
pop.subpop.0.species.pipe.source.0 = ec.parsimony.ProportionalTournamentSelection
pop.subpop.0.species.pipe.source.0.size = 7
pop.subpop.0.species.pipe.source.0.pick-worst = false
pop.subpop.0.species.pipe.source.0.fitness-prob = 0.9
```

Or using the default parameters:

```
pop.subpop.0.species.pipe.source.0 = ec.parsimony.ProportionalTournamentSelection
select.bucket-tournament.size = 7
select.bucket-tournament.pick-worst = false
select.bucket-tournament.fitness-prob = 0.9
```

- ec.parsimony.DoubleTournamentSelection is actually two TournamentSelections in a row. In short, we do a TournamentSelection of tournament size N based on fitness: but the entrants to that tournament are not chosen uniformly at random from the subpopulation, but rather are the winners of N *other* tournament selections, each performed based on size. Alternatively, we can first do tournament selections on fitness, then have a final tournament on size.

Thus there are roughly twice as many parameters: ones describing the final tournament, and ones describing the initial (“qualifying”) tournaments

```

pop.subpop.0.species.pipe.source.0 = ec.parsimony.DoubleTournamentSelection

# Final tournament
pop.subpop.0.species.pipe.source.0.size = 2
pop.subpop.0.species.pipe.source.0.pick-worst = false

# Qualifying tournaments
pop.subpop.0.species.pipe.source.0.size2 = 2
pop.subpop.0.species.pipe.source.0.pick-worst2 = false

# Make the qualifying tournament based on size
pop.subpop.0.species.pipe.source.0.do-length-first = true

```

Or using the default parameters:

```

pop.subpop.0.species.pipe.source.0 = ec.parsimony.DoubleTournamentSelection

# Final tournament
select.double-tournament.size = 7
select.double-tournament.pick-worst = false

# Qualifying tournaments
select.double-tournament.size2 = 7
select.double-tournament.pick-worst2 = false

# Make the qualifying tournament based on size
select.double-tournament.do-length-first = true

```

- `ec.parsimony.TarpeianStatistics` implements the “Tarpeian” parsimony pressure method [18]. This method identifies the individuals in the subpopulation with above-average size. Notice that this may not be half the subpopulation: it could be a very small number if they are very large and the others are very small. Then a certain proportion of these individuals, picked randomly, are assigned a very bad fitness, and their evaluated flags are set. This happens *before* evaluation, so the evaluation procedure doesn’t bother to evaluate those individuals further.

The Tarpeian method isn’t a selection procedure: it’s a fitness assignment procedure. As such it’s not implemented as a `SelectionMethod` but rather as a `Statistics` subclass which hooks into the evolutionary loop prior to evaluation.

Let’s say that `TarpeianStatistics` is the only child of our primary `Statistics` object. The parameters would look like this:

```

stat.num-children = 1
stat.child.0 = ec.parsimony.TarpeianStatistics
stat.child.0.kill-proportion = 0.2

```

5.3 Grammatical Evolution (The `ec.gp.ge` Package)

Grammatical Evolution (GE) [22] is an approach to building genetic programming trees using a grammar interpreted by a list representation. The trees are then evaluated and tested. In ECJ the procedure for evaluating Individuals in GE works roughly like this.

- The representation is an arbitrarily long list of ints (See Section 5.1.2), implemented as a special subclass of `IntegerVectorIndividual` called `ec.gp.ge.GEIndividual`.

- The Fitness is typically a KozaFitness.
- The GEIndividual's species is a ec.gp.ge.GESpecies.
- The GESpecies holds a **grammar**, loaded from a file and produced via an ec.gp.ge.GrammarParser, which we will interpret according to the ints in the Individual.
- To assess the fitness of a GEIndividual, we hand it to the GESpecies which interprets it according to the grammar, producing a GPIndividual.
- The GPIndividual is then evaluated in the normal ECJ fashion and its Fitness is set.
- We then transfer the Fitness to the GEIndividual.

We'd like to use plain-old GP test problems to make this as easy as possible. To pull this off we have to do a few minor hacks. First, we must insert the GE conversion process in-between the Evaluator and the GPPProblem that the user wrote. To do this we have a special Problem class called ec.gp.ge.GEProblem, which is assigned as the Evaluator's problem. The GPPProblem is then set up as a subsidiary of the GEProblem. When the Evaluator wishes to evaluate an IntegerVectorIndividual, it calls the GEProblem, which converts it to a GPIndividual and then hands the GPIndividual to the GPPProblem to evaluate. This is done as follows:

```
eval.problem = ec.gp.ge.GEProblem
eval.problem.problem = ec.app.myproblem.MyGProblem
```

Note that GPPProblems usually require auxiliary parameters (not the least of which is their GPData), so we'll need to also say things like...

```
eval.problem.problem.data = ec.app.myproblem.MyGPData
```

... etc. You don't need to define the ADFStack or ADFContext specially because the default parameters for them suffice:

```
gp.problem.stack = ec.gp.ADFStack
gp.adf-stack.context = ec.gp.ADFContext
```

5.3.1 GEIndividuals, GESpecies, and Grammars

The reason we use GEIndividual instead of just IntegerVectorIndividual is simple: when we print out the GEIndividual we wish to print out the equivalent GPIndividual as well. That's the *only* thing GEIndividual does beyond being just a IntegerVectorIndividual.

The GEProblem doesn't actually do the translation from list to tree. Instead, it calls on the GESpecies to do this dirty work. First, let's set the GESpecies, GEIndividual, GrammarParser, and Fitness of Species 0:

```
pop.subpop.0.species = ec.gp.ge.GESpecies
pop.subpop.0.species.parser = ec.gp.ge.GrammarParser
pop.subpop.0.species.ind = ec.gp.ge.GEIndividual
pop.subpop.0.species.fitness = ec.gp.koza.KozaFitness
```

GESpecies requires a **grammar file** for each tree in the GPIndividual. If your GPIndividual has two trees (say), you'll need two grammar files, which are specified like this:

```
pop.subpop.0.species.file.0 = foo.grammar
pop.subpop.0.species.file.1 = bar.grammar
```

Alternatively you can use the default parameter base:

```
ge.species.file.0 = foo.grammar
ge.species.file.1 = bar.grammar
```

Grammar files are text files consisting of lines. Each line can be blank whitespace (which is ignored), a comment (which starts with a #, just like parameter files), or a **grammar rule**. A grammar rule has a **head**, followed by whitespace, followed by the string " ::= ", then more whitespace, and finally a **body**. Here is an example rule:

```
<foo> ::= (hello <bar>) | (yo) | (whoa <bar> <baz>)
```

In this example, <foo> is the head, and (hello <bar>) | (yo) | (whoa <bar> <baz>) is the body. The head is always a simple, usually lower-case, symbol surrounded in angle brackets. The body is a collection of **clauses** separated by the pipe symbol (|). Each clause is a single GP node in Lisp s-expression form.⁷ For example, (hello <bar>) defines a GP node named hello, which has a single child defined by the symbol <bar>.

Terminal (leaf-node) GPNodes are defined as S-expressions with no children. For example, (yo) is a terminal GPNode whose name is yo. And a GPNode can have more than one child, such as (whoa <bar> <baz>).

For each symbol that appears in the body of a rule in angle brackets, there must be at least one such symbol in a head of a rule. However you can have multiple such heads:

```
<foo> ::= (hello <bar>)
<foo> ::= (yo) | (whoa <bar> <baz>)
```

This says the exact same thing as the previous rule example. You are free to use pipe symbols or create separate rules with the same head, or mix and match the two. You can also have plain angle-bracket symbols in the body like this:

```
<foo> ::= (blah <bar>) | <okay>
```

This says that <foo> can expand to either the GPNode blah or it can expand to whatever <okay> expands to. You'd probably want to watch out for recursive definitions. For example, these wouldn't be great rules:

```
<foo> ::= (blah <bar>) | <okay>
<okay> ::= <foo> | (yuck)
```

The **head of the first rule in the file** is the entry point of the grammar and represents the root node of the GPtree. In all of our examples we have called it <start>, but it doesn't have to be that. For example, here is a complete grammar for a very simple tree which produces the same kinds of GPIndividuals as described in the example in Section 5.2.3:

```
<start> ::= <op>
<op> ::= (x) | (y)
<op> ::= (sin <op>) | (* <op> <op>) | (- <op> <op>)
```

5.3.1.1 Strong Typing

At this point we don't see a lot of power. But Grammatical Evolution can define all sorts of typing requirements by specifying which symbols appear where in rules. For example, we could extend this grammar to handle the Strongly-Typed Genetic Programming example shown in Section 5.2.11:

⁷Traditionally, Gramamtical Evolution does not restrict the language for which the grammar is designed: you could plausibly have the system output a C program, for example. However to maintain compatibility with ECJ's GP package, and thus greatly simplify the complexity of the system, ECJ's GE system only outputs in the pseudo-lisp form typical of GP. There's no loss of generality however.

```

<start> ::= <op>
<op> ::= (x) | (y) | (sin <op>) | (* <op> <op>) | (- <op> <op>)
<op> ::= (if <bool> <op> <op>)
<bool> ::= (nand <bool> <bool>)
<bool> ::= (> <op> <op>)

```

If you have a grammar like this, you'd imagine it would need to be accompanied by GPNodes that have been appropriately typed in a strongly typed context. But it's not true. Recall that strong typing is intended to provide constraints for building trees, mutating them, and crossing them over using traditional GP methods. But since Grammatical Evolution is doing all of this based on a list of ints, GPTypes serve no function.

As a result, you should just have a single GPType even in a "strongly typed" example such as the one above. You can have more if you like, but it serves no purpose and may trip you up.

5.3.1.2 ADFs and ERCs

Each GPNode in the grammar is looked up according to its name. Thus if you have a grammar element called (*sin...*), you'll need to have a GPNode whose name() method returns sin. This goes for ERCs and ADFs as well. Typically the name() of an ERC is simply ERC, the name() of an ADF is something like ADF1, and the name() of an ADFArgument is often something like ARG0. Thus you might have a grammar that looks like:

```

<start> ::= <op>
<op> ::= (x) | (y) | (sin <op>) | (* <op> <op>) | (- <op> <op>)
<op> ::= (ERC)
<op> ::= (ADF1 <op> <op>)

```

Then a second grammar file for ADF1 might have something like:

```

<start> ::= <op>
<op> ::= (x) | (y) | (cos <op>) | (+ <op> <op>)
<op> ::= (ARG0) | (ARG1)

```

5.3.2 Translation and Evaluation

Translation is done as follows. GESpecies is handed a GEIndividual, which is little more than an arbitrary-length IntegerVectorIndividual. You should set this GEIndividual to have maximal min-gene and max-gene values, so it can have any of all 256 possible settings per gene:

```

pop.subpop.0.species.min-gene = -128
pop.subpop.0.species.max-gene = 127

```

GESpecies starts working through the int array and the grammar, depth-first. Each time GESpecies comes across a point in the grammar where multiple expansions are possible, it consults the next int in the int array. Let's say there are four possible expansions of the head <foo>, and the next int says 145. We compute $145 \bmod 4 = 1$ and so pick expansion 1 (the second expansion — the first one is expansion 0).

This continues until one of two things happens. Either the tree (or tree forest) is completed, or we run out of ints. In the first case, the tree is finished. In the second case, processing continues again at the first int (so-called **wrapping**). If after some number of wrapping iterations the tree is still not completed, the translation process is halted and the fitness is simply set to the worst possible Koza Standardized Fitness (Double.MAX_VALUE).

You specify the number of wrappings using the following parameter:

```
pop.subpop.0.species.passes = 4
```

or alternatively

```
ge.species.passes = 4
```

This tells ECJ that it may pass through the genome no more than 4 times (including the original pass). At present this value must be a **power of two**, and should be less than `MAXIMUM.PASSES`, presently set to 1024. In fact you should make it much smaller than this, perhaps 8 or 16, because with large genomes, if you have many passes, the recursion stack depth of the tree generator can be easily exceeded, which will throw an error internally and eventually result in (once again) the fitness being set to `Double.MAX.Value`.

This scheme allows ECJ to do both of the common GE approaches to handling over-size genomes: either killing them immediately or wrapping around some N number of times. I prefer the first approach, and so by default have `passes` set to 1.

At any rate, once a tree or tree forest is completed, we record the position in the int array where we had stopped. If there are more trees yet to produce for the `GPIndividual` (for ADFs for example), we build the next one starting at that position, and so on, until the `GPIndividual` is completed. Then we send the `GPIndividual` to the `GPPProblem` to be evaluated, and after evaluation the `GEIndividual`'s fitness is set to the `GPIndividual`'s fitness, the `GEIndividual`'s evaluated flag is set to the `GPIndividual`'s flag, and evaluation of the `GEIndividual` is now done.

To do the translation, `GESpecies` relies on certain methods that may be useful to you:

ec.gp.ge.GESpecies Methods

```
public int makeTree(EvolutionState state, int[] genome, GPTree tree, int position, int treeNum, int threadnum,
                  HashMap ERCmap)
```

Builds a `GPTree` from the genome of a `GEIndividual`. The tree is stored in `tree`. The tree number (and thus the particular grammar to be used) is defined by `treeNum`. Ints are read from the `GEIndividual`'s genome starting at `position`. When the tree has been generated, the first unread int position is returned. If the tree could not be built because there were not enough ints, then `ec.gp.ge.GESpecies.BIG_TREE_ERROR` is returned instead. If `ERCmap` is non-null, then as the tree is being built, any ERCs appearing the tree are registered in the `ERCmap` as the key-value pair $\langle \textit{Gene Value} \rightarrow \textit{ERC} \rangle$ where *Gene Value* is the gene value used (an int), and *ERC* is the a `ec.gp.ERC` object which has the same value as the actual ERC object used. You should treat this map as read-only. If you don't care about any of this, just pass in null.

```
public int makeTrees(EvolutionState state, int[] genome, GPTree[] trees, int threadnum, HashMap ERCmap)
```

Builds an entire array of `GPTrees`, sufficient to create an entire `GPIndividual`, from the genome of a `GEIndividual`. The trees are stored in `trees`. Ints are read from the `GEIndividual`'s genome starting at position 0. When the tree has been generated, the first unread int position is returned. If the trees could not be built because there were not enough ints, then `ec.gp.ge.GESpecies.BIG_TREE_ERROR` is returned instead. If `ERCmap` is non-null, then as the tree is being built, any ERCs appearing the tree are registered in the `ERCmap` as the key-value pair $\langle \textit{Gene Value} \rightarrow \textit{ERC} \rangle$ where *Gene Value* is the gene value used (an int), and *ERC* is the a `ec.gp.ERC` object which has the same value as the actual ERC object used. You should treat this map as read-only. If you don't care about any of this, just pass in null.

```
public int makeTrees(EvolutionState state, GEIndividual ind, GPTree[] trees, int threadnum, HashMap ERCmap)
```

Builds an entire array of `GPTrees`, sufficient to create an entire `GPIndividual`, from a `GEIndividual`, possibly performing wrapping. The trees are stored in `trees`. Ints are read from the `GEIndividual` starting at position 0. When the tree has been generated, the first unread int position is returned. **If we have run out of ints and the trees are not completed, then processing continues at position 0 again. This is done some `passes - 1` times (specified in the individual's species). If the trees have still not been completely built, then `ec.gp.ge.GESpecies.BIG_TREE_ERROR` is returned instead.** If `ERCmap` is non-null, then as the tree is being built, any ERCs appearing the tree are registered in the `ERCmap` as the key-value pair $\langle \textit{Gene Value} \rightarrow \textit{ERC} \rangle$ where *Gene Value* is the gene value used (an int), and *ERC* is the a `ec.gp.ERC` object which has the same value as the actual ERC object used. You should treat this map as read-only. If you don't care about any of this, just pass in null.

```
public int consumed(EvolutionState state, GEIndividual ind, int threadnum)
```

Computes and returns the number of ints that would be consumed to produce a GPIndividual from the given GEIndividual, including wrapping as discussed in the previous method. This is done by actually building an individual, then throwing it away. If the GPIndividual could not be built because there were not enough ints, then `ec.gp.ge.GESpecies.BIG_TREE_ERROR` is returned instead.

Handling ERCs When the GESpecies needs to produce an ERC from the grammar, it consults the next int in the array. If the int is 27, it looks up 27 in a special hash table stored in GESpecies. If it finds that 27 has hashed to an existing ERC, it clones this ERC and uses the clone. Else, it creates a new ERC, calls `reset()` on it, stores it in the hash table with 27, clones it, and uses the clone. This way all ERCs whose int is 27 are the same value.

Handling ADFs and Multiple Trees Recall that the GESpecies maintains a separate grammar for each tree in the GPIndividual (and thus for each separate ADF). However there's only a single int array in the GEIndividual. This is handled straightforwardly the array is used to build the first tree; then the unused remainder of the array is used to build the second tree; and so on. If not all trees were able to be built, evaluation of the GPIndividual is bypassed and the fitness is set to the `(Double.MAX_VALUE)`.

Grammatical Evolution Does Not Support GroupedProblemForm GroupedProblemForm (Section 7.1.2) evaluates several Individuals together. What if at least one of them is a GEIndividual, and the GEIndividual cannot generate a valid GPIndividual? This creates a number of hassles. For example, if we're doing cooperative coevolution, and one Individual can't be generated, what's the fitness of the group? Is it fair to penalize the group thusly? Likewise if we're doing competitive coevolution, and one of the competitors can't be generated, what's the resulting fitness of the other? For this reason, at present Grammatical Evolution does not support GroupedProblemForm.

5.3.3 Printing

GEIndividual prints itself (via `printIndividualForHumans(...)`) by first printing itself in the standard way, then translating and printing the GPTrees from equivalent GPIndividual, then finally printing the ERC mappings used by this GEIndividual in the GESpecies ERC hash table. For example, consider the GEIndividual below:

```
Evaluated: T
Fitness: Standardized=1.0308193 Adjusted=0.49241206 Hits=5
-96 122 -92 -96 -50 -96 122 122 -96 122 -92 -50 -50 -50 111 -50 111 111 -50 -50 111 -50 111
Equivalent GP Individual:
Tree 0:
(* (+ (exp (* x (* (+ (+ (* (+ (exp x) x)
x) x) 0.4099041340133447) 0.25448855944201476)))
x) x)
ERCs: 111 -> 0.25448855944201476 -50 -> 0.4099041340133447
```

In this individual, two ERCs were used, 0.25448855944201476 and 0.4099041340133447, and they were associated with gene values 111 and -50 respectively. Note that in both cases the genome has these genes appearing multiple times: but not all these elements were used as ERCs: some were used as choice points or functions in the grammar, and others (near the end of the string) were ignored.

Individuals don't have to have any ERCs at all of course. Here is a perfect Symbolic Regression individual:

```

Evaluated: T
Fitness: Standardized=0.0 Adjusted=1.0 Hits=20
 112 80 -126 -40 112 80 -126 -40 112 80 -126 -40 -40 21 112
Equivalent GP Individual:
Tree 0:
 (+ x (* x (+ x (* x (+ x (* x x))))))
ERCs:

```

5.3.4 Initialization and Breeding

Since we're doing lists, we'll need to define the parameters for creating new lists in the first place. The default parameters in `ge.params` do geometric size distribution as follows:

```

pop.subpop.0.species.genome-size = geometric
pop.subpop.0.species.geometric-prob = 0.85
pop.subpop.0.species.min-initial-size = 5

```

Change this to your heart's content.

While we could use things like `ListCrossoverPipeline`, GE has two idiosyncratic list breeding operators:

- `ec.vector.breed.GeneDuplicationPipeline` picks two random indices in the list, copies the int sequence between them, then tacks the copy to the end of the list. Because this doesn't rely on anything special to GE, it's located in `ec.breed.vector`.
- `ec.gp.ge.breed.GETruncationPipeline` determines how many ints were consumed in the production of the GP tree. It then truncates the list to remove the unused ints.

The default pipeline in `ge.params` is a `MultiBreedingPipeline` which with 0.9 probability performs `GETruncation`, followed by crossover; and with 0.05 probability performs `GETruncation` followed by `GeneDuplication`; and 0.05 probability simply does plain `VectorMutation`. In all cases we use `Tournament Selection` with size of 7.

```

pop.subpop.0.species.pipe = ec.breed.MultiBreedingPipeline
pop.subpop.0.species.pipe.num-sources = 3

pop.subpop.0.species.pipe.source.0 = ec.vector.breed.ListCrossoverPipeline
pop.subpop.0.species.pipe.source.0.source.0 = ec.gp.ge.breed.GETruncationPipeline
pop.subpop.0.species.pipe.source.0.source.0.source.0 = ec.select.TournamentSelection
pop.subpop.0.species.pipe.source.0.source.1 = same
pop.subpop.0.species.pipe.source.0.prob = 0.9

pop.subpop.0.species.pipe.source.1 = ec.vector.breed.GeneDuplicationPipeline
pop.subpop.0.species.pipe.source.1.source.0 = ec.gp.ge.breed.GETruncationPipeline
pop.subpop.0.species.pipe.source.1.source.0.source.0 = ec.select.TournamentSelection
pop.subpop.0.species.pipe.source.1.prob = 0.05

pop.subpop.0.species.pipe.source.2 = ec.vector.breed.VectorMutationPipeline
pop.subpop.0.species.pipe.source.2.source.0 = ec.select.TournamentSelection
pop.subpop.0.species.pipe.source.2.prob = 0.05

select.tournament.size = 7

```

You are of course welcome to change this any way you like.

The default pipeline also defines the mutation probability for `VectorMutationPipeline`, and includes a crossover type even though it's unused (to quiet complaints from ECJ):

```

pop.subpop.0.species.mutation-prob = 0.01
# This isn't used at all but we include it here to quiet a warning from ECJ
pop.subpop.0.species.crossover-type = one

```

5.3.5 Dealing with GP

Once you've created your grammar and set up your GEIndividual and GESpecies, you'll still need to define all the same GPNodes, GPFunctionSets, GPNodeConstraints, GPTreeConstraints, etc. as usual. All GE is doing is giving you a new way to breed and create trees: but the tree information must still remain intact. However, certain items must be redefined because the GPSpecies is no longer in the normal parameter base (pop.subpop.0.species) but rather is the subsidiary to GESpecies, and thus at the parameter base (pop.subpop.0.species.gp-species). The simplest way to do this is to include ec/gp/koza/koza.params to define all the basic GP stuff, then create all of your GPNodes etc., and then override certain GP parameters, namely:

```

# We define a dummy KozaFitness here, and set the number of trees to 1.
# If you're doing ADFs, you'll need to add some more trees.
pop.subpop.0.species.gp-species = ec.gp.GPSpecies
pop.subpop.0.species.gp-species.fitness = ec.gp.koza.KozaFitness
pop.subpop.0.species.gp-species.ind = ec.gp.GPIndividual
pop.subpop.0.species.gp-species.ind.numtrees = 1
pop.subpop.0.species.gp-species.ind.tree.0 = ec.gp.GPTree
pop.subpop.0.species.gp-species.ind.tree.0.tc = tc0

# We also need a simple dummy breeding pipeline for GP, which will never
# be used, but if it's not here GP will complain. We'll just use Reproduction.
pop.subpop.0.species.gp-species.pipe = ec.breed.ReproductionPipeline
pop.subpop.0.species.gp-species.pipe.num-sources = 1
pop.subpop.0.species.gp-species.pipe.source.0 = ec.select.TournamentSelection

```

This is enough to convince the GP system to go along with our bizarre plans.

One Last Note There are some unusual and very rare cases where you may need to run GPIndividuals and GEIndividuals using the same problem class. To assist in this, GEProblem can recognize that GPIndividuals are being passed to it rather than GEIndividuals, in which case it simply evaluates them directly in the subsidiary GPProblem. You will receive a once-only warning if this happens. No other kinds of Individuals can be given to GEProblem: it'll issue an error.

5.3.6 A Complete Example

We will continue the example given in Section 5.2.11. We don't include the parameters and Java files specified so far in that example, but you'll of course need them.

That example showed how to do a strongly-typed Individual with various functions, plus an ADF and an ERC. The ADF points to a tree that contains the same basic functions, plus another ERC and two ADFArguments. Keep in mind that strong typing just gets in our way, but in this example, it's fairly harmless. We use all the existing parameters, but change a few. First, let's do the most of the ones we've discussed so far:

```

# Basic parameters that we redefine
eval.problem = ec.gp.ge.GEProblem
pop.subpop.0.species = ec.gp.ge.GESpecies
pop.subpop.0.species.parser = ec.gp.ge.GrammarParser
pop.subpop.0.species.gp-species = ec.gp.GPSpecies
pop.subpop.0.species.fitness = ec.gp.koza.KozaFitness
pop.subpop.0.species.ind = ec.gp.ge.GEIndividual
pop.subpop.0.species.min-gene = -128
pop.subpop.0.species.max-gene = 127
pop.subpop.0.species.mutation-prob = 0.01
pop.subpop.0.species.crossover-type = one
pop.subpop.0.species.genome-size = geometric
pop.subpop.0.species.geometric-prob = 0.85
pop.subpop.0.species.min-initial-size = 5

# The pipeline
pop.subpop.0.species.pipe = ec.breed.MultiBreedingPipeline
pop.subpop.0.species.pipe.num-sources = 3
pop.subpop.0.species.pipe.source.0 = ec.vector.breed.ListCrossoverPipeline
pop.subpop.0.species.pipe.source.0.source.0 = ec.gp.ge.breed.GETruncationPipeline
pop.subpop.0.species.pipe.source.0.source.0.source.0 = ec.select.TournamentSelection
pop.subpop.0.species.pipe.source.0.source.1 = same
pop.subpop.0.species.pipe.source.0.prob = 0.9
pop.subpop.0.species.pipe.source.1 = ec.vector.breed.GeneDuplicationPipeline
pop.subpop.0.species.pipe.source.1.source.0 = ec.gp.ge.breed.GETruncationPipeline
pop.subpop.0.species.pipe.source.1.source.0.source.0 = ec.select.TournamentSelection
pop.subpop.0.species.pipe.source.1.prob = 0.05
pop.subpop.0.species.pipe.source.2 = ec.vector.breed.VectorMutationPipeline
pop.subpop.0.species.pipe.source.2.source.0 = ec.select.TournamentSelection
pop.subpop.0.species.pipe.source.2.prob = 0.05
select.tournament.size = 7

# GP hacks
pop.subpop.0.species.gp-species.fitness = ec.gp.koza.KozaFitness
pop.subpop.0.species.gp-species.ind = ec.gp.GPIndividual
pop.subpop.0.species.gp-species.pipe = ec.breed.ReproductionPipeline
pop.subpop.0.species.gp-species.pipe.num-sources = 1
pop.subpop.0.species.gp-species.pipe.source.0 = ec.select.TournamentSelection

```

You don't have to specify all this: just include `ge.params` as a parent of your parameter file.

Since we're doing ADFs, we'll need **two trees** rather than just one. `ge.params` by default defines a single tree. We do two here:

```

# More GP hacks to handle an ADF
pop.subpop.0.species.gp-species.ind.numtrees = 2
pop.subpop.0.species.gp-species.ind.tree.0 = ec.gp.GPTree
pop.subpop.0.species.gp-species.ind.tree.0.tc = tc0
pop.subpop.0.species.gp-species.ind.tree.1 = ec.gp.GPTree
pop.subpop.0.species.gp-species.ind.tree.1.tc = tc1

```

Next let's hook up the Problem, which was originally called `ec.app.myapp.MyProblem`:

```
# The problem
eval.problem.problem = ec.app.myapp.MyProblem
eval.problem.problem.data = ec.app.myapp.MyData
```

Now for each tree (the main tree and the ADF) we need to define the grammar files:

```
# The grammars
ge.species.file.0 = myproblem.grammar
ge.species.file.1 = adf0.grammar
```

5.3.6.1 Grammar Files

The myproblem.grammar file defines our basic functions (both boolean and real-valued) and also our ADF and ERC.

```
# This is the grammar file for the main tree
<start> ::= <op>
<op> ::= (x) | (y) | (sin <op>) | (* <op> <op>) | (- <op> <op>)
<op> ::= (ERC)
<op> ::= (ADF <op> <op>)
<op> ::= (if <bool> <op> <op>)
<bool> ::= (nand <bool> <bool>)
<bool> ::= (> <op> <op>)
```

The adf0.grammar file uses just the real-valued functions, plus an ERC and two ADFArguments:

```
# This is the grammar file for ADF0, which requires two arguments
<start> ::= <op>
<op> ::= (x) | (y) | (sin <op>) | (* <op> <op>) | (- <op> <op>)
<op> ::= (ERC)
<op> ::= (ARG0) | (ARG1)
```

5.3.7 How Parsing is Done

GESpecies parses the grammar files by running them through an ec.gp.ge.GrammarParser, a special class which converts the files into parse graphs. The parse graphs consist of two kinds of nodes: a ec.gp.ge.GrammarFunctionNode and a ec.gp.ge.GrammarRuleNode, both subclasses of the abstract class ec.gp.ge.GrammarNode. You can replace ec.gp.ge.GrammarParser with your own subclass if you like, via:

```
pop.subpop.0.species.parser = ec.app.MySpecialGrammarParser
```

The parse graph produced by a GrammarParser is rooted with a GrammarRuleNode which indicates the initial rule. For example, reconsider the grammar below.

```
<start> ::= <op>
<op> ::= (x) | (y) | (sin <op>) | (* <op> <op>) | (- <op> <op>)
<op> ::= (if <bool> <op> <op>)
<bool> ::= (nand <bool> <bool>)
<bool> ::= (> <op> <op>)
```

The parse graph for this grammar is shown in Figure 5.10. Once the parse graph has been generated, the GESpecies wanders through this graph as follows:

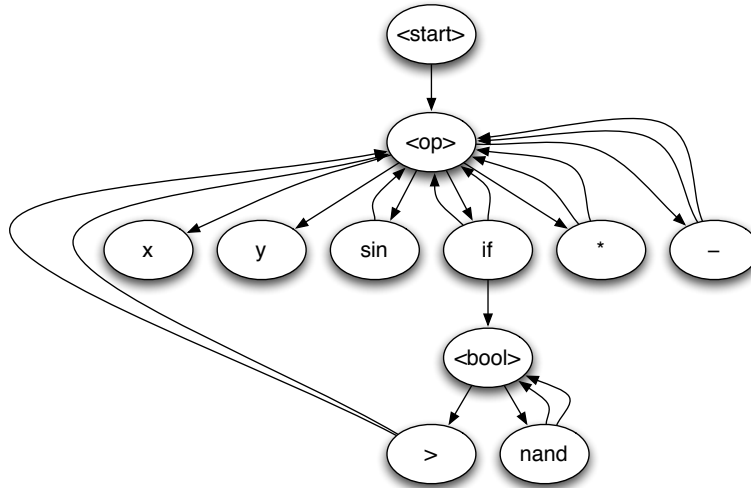

Figure 5.10 Parse graph (orderings among children not shown). The entry point is `<start>`. GrammarRuleNodes are shown with angle brackets. GrammarFunctionNodes are shown without brackets.

- If on a GrammarRuleNode, the GESpecies selects exactly one child to traverse, using the next number in the GEIndividual array.
- If on a GrammarFunctionNode, the GESpecies traverses each and every child of the node in order. These become children to the GrammarFunctionNode's GPNode.

GrammarFunctionNodes hold GPNode prototypes and represent them. Their children are arguments to the node in question. GrammarRuleNodes hold choice points in the rule, and their children are the choices (only one choice will be made).

5.4 Push (The `ec.gp.push` Package)

Push is a stack-based programming language developed by Lee Spector [25, 24]. The language is designed to allow the evolution of self-modifying programs, and this allows all manner of experimentation. ECJ has an **experimental** simple implementation of Push which uses a Push interpreter called Psh.⁸

The Push interpreter has several stacks on which data of different types can be pushed, popped, or otherwise manipulated. Built-in Push instructions designed to manipulate certain stacks usually have the name of the stack at the beginning of the instruction name, for convenience. For example, `float.+` is an instruction which adds floating-point numbers found on the float stack. The Psh interpreter has a large number of built-in instructions: but you can also create your own instructions in ECJ to do whatever you like, and add them to Psh's vocabulary.

Push programs take the form of Lisp lists of arbitrary size and nesting. For example, here is an uninteresting Push program consisting entirely of instructions which use the float stack:

```
((float.swap ((float.swap float.dup))) float.dup float.* (float.+ float.-) float.dup)
```

Parentheses define blocks of code, but if you don't have any code-manipulation instructions then parentheses don't mean much. This code does the following:

⁸<https://github.com/jonklein/Psh/> Note that ECJ uses a modified version of Psh which comes with the ECJ distribution: don't use the GitHub version.

1. Swap the top two elements of the float stack
2. Swap the top two elements of the float stack
3. Duplicate the top item of the float stack and push it on the float stack
4. Duplicate the top item of the float stack and push it on the float stack
5. Multiply the top two items of the float stack and push the result on the float stack
6. Add the top two items of the float stack and push the result on the float stack
7. Subtract the top two items of the float stack and push the result on the float stack
8. Duplicate the top item of the float stack and push it on the float stack

Like I said, an uninteresting program.

Note that unlike in Lisp or GP tradition, the first element in each list in Psh isn't special: it doesn't define a function. Indeed it could just be another list. All lists do is set apart blocks of code, which might be useful in manipulation by special code-modifying instructions.

Because Push lists don't start with a function symbol, their parse trees are different from GP program trees, and so while ECJ uses the GPNode and GPTree classes to encode Push trees, it does so in an unusual way. All the symbols in the Push program are leaf nodes in the tree. Dummy nonleaf nodes define the list and sublist structure of the tree. Furthermore, nonleaf nodes can have *arbitrary arity*, which is something not normally done in ECJ's GP trees. For example, the previous Push program looks like this in tree form:

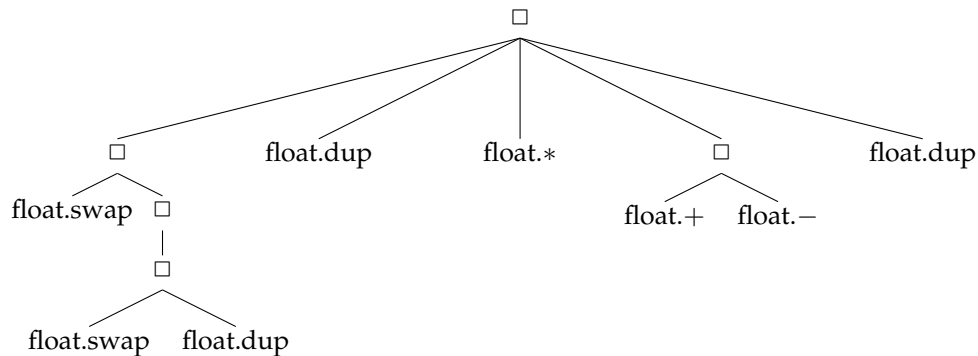

Thus ECJ creates Push programs using its GPTree facility with only two kinds of nodes: *dummy nonterminals* (the class `ec.gp.push.Nonterminal`) and *instructions* (the class `ec.gp.push.Terminal`, which is a special ECJ ERC that handles leaf nodes in the tree). The dummy nonterminals are shown in the figure above with the symbol `□`.

Evaluation Push trees are evaluated by submitting them to an interpreter, in this case the Psh interpreter. But there's a problem. Psh, like every other Push interpreter out there, has its own notions of the objects used to construct a Push tree. It's obviously not compatible with ECJ's GPNode, GPTree, and GPIndividual objects. As a result, ECJ evaluates its Push trees by first writing them out to strings in Lisp form. It then sets up an interpreter, gives it the string program, and lets it parse the program into its own internal structure and evaluate it. This is circuitous but doesn't really slow things down very much as it turns out.

Some Caveats Much of the modern Push work is being done on a Clojure-based interpreter (Clojush) rather than Psh, and perhaps in the future we may move to that instead. Long story short, this is an experimental package.

Also, much of the Push literature involves individuals which modify themselves and then pass these modifications onto successive generations. At present ECJ does not do this: once an individual is entered into

the interpreter, it stays there. Any changes made in the interpreter are ignored when the fitness evaluation is complete. We may change that in the future.

5.4.1 Push and GP

ECJ's Push package only uses two GPNode classes, `ec.gp.push.Nonterminal` (for dummy nonleaf nodes) and `ec.gp.push.Terminal` (to define all possible leaf nodes). This means that, for all intents and purposes, the GP function set, from ECJ's perspective, is hard-coded. But of course you still have the *Push* "function set" to set up: these are the actual instructions that `ec.gp.push.Terminal` can be set to (it's an ERC which displays Strings) and that can be submitted to the Psh interpreter. Setting these instructions up is discussed in Section 5.4.2 coming next; for now, keep in mind that the Push "function set" is *not the same thing* as the GP function set.

This "hard-coded" GP function set is defined as follows in the `ec/gp/push/push.params` file:

```
gp.fs.size = 1
gp.fs.0.name = f0
gp.fs.0.size = 2
gp.fs.0.func.0 = ec.gp.push.Nonterminal
gp.fs.0.func.0.nc = nc1
gp.fs.0.func.1 = ec.gp.push.Terminal
gp.fs.0.func.1.nc = nc0
```

Note that `Nonterminal` is listed as having an arity of 1 even though it has an arbitrary arity. Because `ec.gp.push.Nonterminal` can have variable number of children, Push uses its own special tree builder to allow this. The class is called `ec.gp.push.PushBuilder`. `PushBuilder` follows the following algorithm:

```
1: function BUILD-TREE (int size)
2:   if size = 1 then
3:     return a terminal (of the class ec.gp.push.Terminal)
4:   else
5:      $p \leftarrow$  a nonterminal (of the class ec.gp.push.Nonterminal)
6:     while size > 0 do
7:        $a \leftarrow$  a random number from 1 to size inclusive
8:        $size \leftarrow size - a$ 
9:        $c \leftarrow$  Build-Tree(a)
10:      Add c as a child of p
11:   Randomly shuffle the order of children of p
12:   return p
```

`PushBuilder` must choose a size, and this is done in the usual `GPNodeBuilder` way. To set up `PushBuilder` as the default initialization builder, and define it to pick sizes uniformly between 4 and 10 inclusive, you'd say:

```
gp.tc.0.init = ec.gp.push.PushBuilder
gp.tc.0.init.min-size = 4
gp.tc.0.init.max-size = 10
```

You can of course define the size distribution directly too, to describe a more complicated distribution:

```

gp.tc.0.init = ec.gp.push.PushBuilder
gp.tc.0.init.num-sizes = 10
gp.tc.0.init.size.0 = 0.0
gp.tc.0.init.size.1 = 0.0
gp.tc.0.init.size.2 = 0.0
gp.tc.0.init.size.3 = 0.0
gp.tc.0.init.size.4 = 0.5
gp.tc.0.init.size.5 = 0.25
gp.tc.0.init.size.6 = 0.125
gp.tc.0.init.size.7 = 0.0625
gp.tc.0.init.size.8 = 0.03125
gp.tc.0.init.size.9 = 0.015625
gp.tc.0.init.size.10 = 0.015625

```

Because ECJ's Push package only uses two GPNode classes, you can basically use any GP crossover or mutation method you like, as long as it doesn't rely on a fixed arity (`ec.gp.push.Nonterminal` has a variable number of children). None of the built-in ECJ GP breeding pipelines will cause any problem. However if you're using a breeding pipeline which creates random subtrees (such as `ec.gp.koza.MutationPipeline`) you will want to make sure it uses the `ec.gp.push.PushBuilder` tree builder to generate those subtrees.

5.4.2 Defining the Push Instruction Set

Though the GP function set used by ECJ's GP facility is hard-coded for Push, you still of course have to specify the instructions which can form a Push program. This is done via the `ec.gp.push.Terminal`.

Let's say you wanted to do a symbolic regression problem and had settled on the following seven Push instructions: `float.* float.+ float.% float.- float.dup float.swap float.pop`. You'd set it up like this:

```

# The Instruction Set
push.in.size = 7
push.in.0 = float.*
push.in.1 = float.+
push.in.2 = float.%
push.in.3 = float.-
push.in.4 = float.dup
push.in.5 = float.swap
push.in.6 = float.pop

```

This is, in effect, the Push equivalent of a GP Function Set. Psh also supports a limited number of Ephemeral Random Constants, or ERCs. Keep in mind that these are *not* GP ERCs, though they operate similarly inside the Push interpreter. ECJ defines these with the names `float.erc` and `int.erc`, one for Push's float stack and one for the integer stack. So if you'd like to add an ERC to your instruction set, you might say:

```

push.in.size = 8
push.in.0 = float.*
push.in.1 = float.+
push.in.2 = float.%
push.in.3 = float.-
push.in.4 = float.dup
push.in.5 = float.swap
push.in.6 = float.pop
push.in.7 = float.erc

```

If you use an ERC, you should also set its minimum and maximum values. ECJ defines the following defaults in the `push.params` file:

```

push.erc.float.min = -10.0
push.erc.float.max = 10.0
push.erc.int.min = -10
push.erc.int.max = 10

```

The following instructions are built into the Psh interpreter.

integer.+	float.+	boolean.=	code.quote	input.index
integer.-	float.-	boolean.not	code.fromboolean	input.inall
integer./	float./	boolean.and	code.frominteger	input.inallrev
integer.%	float.%	boolean.or	code.fromfloat	input.stackdepth
integer.*	float.*	boolean.xor	code.noop	
integer.pow	float.pow	boolean.frominteger	code.do*times	frame.push
integer.log	float.log	boolean.fromfloat	code.do*count	frame.pop
integer.=	float.=	boolean.rand	code.do*range	
integer.>	float.>		code.=	
integer.<	float.<	true	code.if	
integer.min	float.min	false	code.rand	
integer.max	float.max			
integer.abs	float.sin		exec.k	
integer.neg	float.cos		exec.s	
integer.ln	float.tan		exec.y	
integer.fromfloat	float.exp		exec.noop	
integer.fromboolean	float.abs		exec.do*times	
integer.rand	float.neg		exec.do*count	
	float.ln		exec.do*range	
	float.frominteger		exec.=	
	float.fromboolean		exec.if	
	float.rand		exec.rand	

5.4.3 Creating a Push Problem

Push Problems are created by subclassing from `ec.gp.push.PushProblem`. Building a Push Problem is more complex than other ECJ Problems because you may have to interact with the Psh interpreter. We have provided some cover functions to enable you to keep your hands relatively clean.

One common way a Push program is evaluated (such as in Symbolic Regression) is along these lines:

1. A Push Program is created from the `GPIndividual`.
2. An Interpreter is created or reset.
3. Certain stacks in the interpreter are loaded with some data
4. The program is run on the interpreter
5. The tops of certain stacks in the interpreter are inspected to determine the return value, and thus the fitness.
6. The `GPIndividual`'s fitness is set to this fitness.

To create a Push Program, you'd call `getProgram(...)`, passing in the individual in question. This will return a Program object (this is a class used in Psh).

To create an interpreter, you'd call `getInterpreter(...)`, again passing in the individual in question. This will return an Interpreter object (another class used in Psh). You can also call `resetInterpreter(...)` to reset the interpreter to a pristine state so you can reuse it.

Let's say your approach is to push a number on the float stack of the interpreter, run the program, and then examine what's left on the float stack to determine fitness. `PushProblem` has utility methods for pushing, and examining the float and integer stacks. If you want to do more sophisticated stuff than this, you're welcome to but will have to consult `Psh` directly.

Finally, to run the program on the interpreter, you can call `executeProgram(...)`.

ec.gp.push.PushProblem Methods

```
public org.spiderland.Psh.Program getProgram(EvolutionState state, GPIndividual ind)
    Builds and returns a new Program object from the provided individual.

public org.spiderland.Psh.Interpreter getInterpreter(EvolutionState state, GPIndividual ind, int thread)
    Builds and returns a new, empty Interpreter object.

public void resetInterpreter(org.spiderland.Psh.Interpreter interpreter)
    Resets the interpreter's stack so it can execute a new program.

public void executeProgram(org.spiderland.Psh.Program program, org.spiderland.Psh.Interpreter interpreter, int maxSteps)

    Runs the provided program on the given interpreter for up to maxSteps steps.

public void pushOntoFloatStack(org.spiderland.Psh.Interpreter interpreter, float val)
    Pushes the given value onto the interpreter's float stack.

public void pushOntoIntStack(org.spiderland.Psh.Interpreter interpreter, int val)
    Pushes the given value onto the interpreter's integer stack.

public boolean isFloatStackEmpty(org.spiderland.Psh.Interpreter interpreter)
    Returns whether the interpreter's float stack is empty.

public boolean isIntStackEmpty(org.spiderland.Psh.Interpreter interpreter)
    Returns whether the interpreter's integer stack is empty.

public float topOfFloatStack(org.spiderland.Psh.Interpreter interpreter)
    Returns the top element on the interpreter's float stack. You ought to check to see if the stack is empty first.

public int topOfIntStack(org.spiderland.Psh.Interpreter interpreter)
    Returns the top element on the interpreter's stack. You ought to check to see if the stack is empty first.
```

You will define your `PushProblem` in the usual ECJ fashion. Furthermore, since `Push` uses the GP facility, you also need to provide a `GPData` object, though it'll never be used:

```
eval.problem = ec.app.myapp.MyPushProblem
eval.problem.data = ec.gp.GPData
```

5.4.4 Building a Custom Instruction

It's often the case that `Psh`'s built-in instructions aren't enough for you. Perhaps you want an instruction which prints the top of the float stack. Perhaps you want an instruction which does more interesting math, or which reads from a file, or moves an ant. To do this you need to be able to create a class which you can submit as an instruction. This is what `ec.gp.push.PushInstruction` does for you.

`PushInstruction` is a `org.spiderland.Psh.Instruction` subclass which also implements ECJ's `ec.Prototype` interface and so is properly cloneable and serializable. Since it's a `Prototype`, it has a `setup(...)` method which you can take advantage of to get things ready, and a `clone()` method you might need to override. But critically it has an `Execute(...)` method which the interpreter uses to run the instruction. Note the unusual spelling: this is a `Psh` method name.

To implement a PushInstruction you'll need to know how Psh works so you can manipulate its stacks according to the needs of the instruction. Two examples (Atan and Print) are provided in the `ec/app/push` application example.

ec.gp.push.PushInstruction Methods

```
public void Execute(org.spiderland.Psh.Interpreter interpreter)
    Executes the given instruction.
```

Once you have constructed your custom instruction, you need to add it to your instruction set. To do this you give it a name and also specify the PushInstruction class which defines the instruction. The presence of this class specification informs ECJ that this isn't a built-in Psh instruction. For example, we might add to the end of our existing instruction set like so:

```
push.in.size = 9
push.in.0 = float.*
push.in.1 = float.+
push.in.2 = float.%
push.in.3 = float.-
push.in.4 = float.dup
push.in.5 = float.swap
push.in.6 = float.pop
push.in.7 = float.erc
push.in.8 = my.instruction.name
push.in.8.func = ec.app.myapp.MyInstruction
```

5.5 NEAT (The `ec.neat` Package)

NEAT [27] is a direct-encoding⁹ representation for neural networks and related graph structures. ECJ's NEAT implementation tries to stay fairly faithful to the original. ECJ does not at support NEAT extensions, such as HyperNEAT. Note that NEAT is not a simple representation, and this manual is not a place to learn about how NEAT works. You would do well to read up on NEAT first to get your head wrapped around the stuff discussed here.

A NEAT individual consists of two vectors: a vector of *genes* and a vector of *nodes*. ECJ represents NEAT individuals with the class `ec.neat.NEATIndividual`, which is a subclass of `ec.vector.GeneVectorIndividual`. Neat's genes are stored in the genome inherited from `GeneVectorIndividual`, and the nodes are stored in a separate `ArrayList` called `nodes`. All `NEATIndividuals` belong to the species `ec.neat.NEATSpecies`. Genes are represented by the class `ec.neat.NEATGene`, which naturally extends `ec.vector.Gene`. Nodes are represented by the class `ec.neat.NEATNode`.

NEAT uses the term **species** to refer to individuals tagged to belong to a special subgroup. This obviously conflicts with ECJ's usage of the term. To refer to a NEAT species, ECJ uses the term **subspecies**, represented by the class `ec.neat.NEATSubspecies`.

The phenotype of a NEAT individual is a graph structure which represents the individual's neural network. It is represented by `ec.neat.NEATNetwork` and is built up out of `NEATNodes`.

One of NEAT's, um, innovations, is its use of the *innovation number*. This is a unique birthday number which distinguishes and orders `NeatGenes`. Innovation numbers are particularly prevalent (and complex) among links between nodes, and ECJ represents those innovation values with a special class called `ec.neat.NEATInnovation`.

⁹This means that the genome explicitly contains every single node and edge. As opposed to *indirect encoding*, where the genome contains a set of (possibly very compact) rules for how to "grow" a complex neural network.

Finally, NEAT has a custom breeding procedure and so has its own `ec.neat.NEATBreeder`, as well as a custom `ec.neat.NEATInitializer`.

A Warning on NEAT Breeding NEAT has a custom breeding procedure. For the time being ECJ is hard-coding that breeding procedure in `NEATBreeder` (no `BreedingPipelines`) to make sure that it's 100% faithful to the original NEAT code. But after we have verified this, eventually ECJ will carefully break this out into a `Breeding Pipeline` model, and `NEATBreeder` will go away. Stay tuned.

5.5.1 Building a NEAT Application

We'll use the simple package as our default, and begin by specifying all of the above classes:

```
parent.0 = ../simple/simple.params

init = ec.neat.NEATInitializer
breed = ec.neat.NEATBreeder
pop.subpop.0.species = ec.neat.NEATSpecies
pop.subpop.0.species.fitness = ec.simple.SimpleFitness
pop.subpop.0.species.ind = ec.neat.NEATIndividual
pop.subpop.0.species.network = ec.neat.NEATNetwork
pop.subpop.0.species.gene = ec.neat.NEATGene
pop.subpop.0.species.node = ec.neat.NEATNode
pop.subpop.0.species.subspecies = ec.neat.NEATSubspecies
pop.subpop.0.species.innovation = ec.neat.NEATInnovation
```

Note that `NEATIndividual` is a subset of `VectorIndividual`, though it does some things differently. This means we'll need a few dummy parameters that `VectorIndividual` is expecting, even though we won't use them. Notably:

- NEAT builds genomes from templates loaded from a file, so the `genome-size` parameter isn't used.
- NEAT has its own mutation and crossover mechanisms, so `crossover-type` and `mutation-prob` aren't used (for now).
- ECJ's NEAT package doesn't use a pipeline for the time being, so we need to stub that out.

So here we go:

```
# Dummy parameters to satisfy VectorSpecies
pop.subpop.0.species.genome-size = 20
pop.subpop.0.species.crossover-type = one
pop.subpop.0.species.mutation-prob = 0.01
pop.subpop.0.species.pipe = ec.breed.InitializationPipeline
```

5.5.1.1 Breeding

Next we'll go through all the NEAT breeding parameters.

NEAT Breeding is an elaborate process involving fitness-sharing within subspecies, "innovation numbers" (birthdays) aging, population stagnation checks, "champions", "stolen babies" (we kid you not), and other stuff. But in short: each subspecies compete to produce some number of individuals based on various factors. Within a subspecies, individuals are selected for breeding using various fitness-sharing metrics. Breeding can involve mutation or crossover or both. Newly-generated individuals are assigned a species which is most genome-compatible with themselves. Finally, empty subspecies are deleted and the remainder are aged.

NEAT Genome Compatibility and Speciation NEAT uses three factors which determine the degree to which individual are genetically compatible: the amount of disjoint genes, the amount of excess genes, and the mutational difference within matching genes. Here are the relative weights of those factors:

```
neat.species.disjoint-coeff = 1.0
neat.species.excess-coeff = 1.0
neat.species.mutdiff-coeff = 0.4
```

An individual must meet a “compatibility threshold” in order to join a subspecies:

```
neat.species.compat-thresh = 3.0
```

Individuals within a subspecies are fitness-penalized for being too old once they reach a certain age:

```
neat.species.dropoff-age = 15
```

Finally, species can take offspring from other species (“steal their babies”) when this parameter is > 0 (the default is 0):

```
neat.species.babies-stolen = 0
```

Survival, Mutation, and Crossover Once NEAT has determined which individuals will be permitted to breed, breeding commences. Here are the default probabilities:

```
# Percentage of subspecies that is permitted to reproduce into the next generation
neat.species.survival-thresh = 0.20

# Probability that mutation will occur only, no crossover
neat.species.mutate-only-prob = 0.25

# Probability that crossover will occur only, no mutation (if mutate-only-prob fails)
neat.species.mate-only-prob = 0.2
```

The probabilities for mutation and crossover are a bit screwy. The general procedure is as follows:

1. With probability `mutate-only-prob`, mutate
2. Else
 - (a) cross over
 - (b) With probability $(1 - \text{mate-only-prob})$, mutate

Obviously, this means that `mate-only-probability` doesn’t really mean “mate-only probability”. It means “mate-only probability assuming you’re not just doing mutating”.

Crossover can be with members of your own species, or with other species. There are three kinds of crossover available in NEAT:

```
# Probability of mating with another subspecies
neat.species.interspecies-mate-prob = 0.001

# Various probabilities of crossover types
neat.species.mate-multipoint-prob = 0.6
neat.species.mate-multipoint-avg-prob = 0.4
# Don't change this one -- it's usually unused neat.species.mate-singlepoint-prob = 0.0
```

Crossover yields a single child and works as follows. In mate-multipoint, every gene up to the length of the more fit parent is matched with its corresponding gene in the less fit parent. For each pair of genes, with 50% probability we select the gene in the fitter parent, else the other. When one parent is longer than the other, the excess genes are included only if from the fitter parent. Mate-multipoint-average is similar, except that the gene weights of the two genes in the pair are averaged to form the gene weight in the final gene. Mate-singlepoint is somewhat like traditional single-point crossover: we pick a gene locus. Genes less than that locus come from one parent and genes greater than the locus come from the other parent. However in NEAT the locus falls *on* a gene: that gene has an averaging performed on it like mate-multipoint-average. Excess is always included as well.

MateSinglePoint is generally left unused.

Mutation can involve changing the values of **links** (the genes) in the genome, enabling or disabling them, or adding new links. Newly added links can be feed-forward or recurrent in the network.

```
## MUTATING LINK WEIGHTS
# Probability of mutating each and every one of the weights of the links in the genome
neat.species.mutate-link-weight-prob = 0.9

# Factor which influences how much a link is mutated
neat.species.weight-mut-power = 2.5

## ENABLING AND DISABLING LINKS
# Probability of randomly enabling or disabling a single gene (link) in the genome
neat.species.mutate-toggle-enable-prob = 0.0

# Probability of reenabling a gene (link)
neat.species.mutate-gene-reenable-prob = 0.0

## ADDING NEW LINKS
# Probability of adding a single new gene (link)
neat.species.mutate-add-link-prob = 0.05

# Probability that this link will be recurrent rather than feed-forward.
# If recurrent, 50% of the time it will be a self-link, and 50% of the
# time it will be a reversed link
neat.species.recur-only-prob = 0.0

# How many times we're willing to try adding a valid new link before giving up
neat.species.new-link-tries = 20
```

Mutation can also involve adding a new random **node** in the genome. Adding a node involves splitting an existing link into two links and putting the node in-between them. The choice of link is biased in certain ways when the genome is small; otherwise it is a randomly-selected link:

```
# Probability of adding a single new node
neat.species.mutate-add-node-prob = 0.03

# How many times we're willing to try adding a new node before giving up
neat.species.new-node-tries = 20

# In genomes this size or greater, mutateAddNode will do a pure random split
neat.species.add-node-max-genome-length = 15
```

5.5.1.2 Evaluation

NEAT works by interpreting its two genomes (the Node array and the Gene (Link) array) to build a neural network or other graph structure. This network is a NEATNetwork. You then evaluate NEATNetwork to see how it performs, and set the NEATIndividual's fitness appropriately.

To build a network from an existing individual, you call:

ec.neat.NEATIndividual Methods

```
public NEATNetwork createNetwork()
```

Returns a NEATNetwork generated from the current genome of the individual.

Like many neural networks, a NEATNetwork consists of **input nodes** (some of which may be hard-coded **bias units**, **output nodes**, and **hidden nodes**). The general procedure is to load the non-bias unit input nodes with values, then pulse the network until information has flowed to the output nodes, then read the result off of the output nodes and compare with the desired output. Finally, we'll **flush** the network to clear it and reuse it.

You'll need to pulse the network at least as many times as the **depth** of the network so the information can flow all the way through. To do all these things, we'll need a few methods:

ec.neat.NEATNetwork Methods

```
public int maxDepth()
```

Returns the maximum depth of the network.

```
public void loadSensors(double[] values)
```

Given n sensor (input) nodes, sets each to emit a corresponding value.

```
public void activate(EvolutionState state)
```

Pulses the network once, flowing information forward one step.

```
public double[] getOutputResults()
```

Returns an array of activation values, one per output node.

```
public void flush()
```

Clears the network and prepares it for reuse.

Example Let's take the XOR example as shown in the package ec.app.xor. We first create the file XOR.java which contains the class XOR. In the evaluate(...) method we'll start with the usual pleasantries:

```
public class XOR extends Problem implements SimpleProblemForm
{
    public void evaluate(EvolutionState state, Individual ind, int subpopulation, int threadnum)
    {
        if (ind.evaluated) return;

        if (!(ind instanceof NEATIndividual))
            state.output.fatal("Whoa! It's not a NEATIndividual!!!", null);

        NEATIndividual neatInd = (NEATIndividual)ind;

        if (!(neatInd.fitness instanceof SimpleFitness))
            state.output.fatal("Whoa! It's not a SimpleFitness!!!", null);
    }
}
```

At this point we're ready to do evaluation. Our NEAT neural network takes three inputs (the first input is a bias unit) in one of four combinations and produces one of four outputs, for each combination, following the standard XOR rule. The inputs and outputs are:

```
// The four possible input combinations to xor
// The first number is for biasing
double[][] in=
{
    {1.0, 0.0, 0.0}, // output 0
    {1.0, 0.0, 1.0}, // 1
    {1.0, 1.0, 0.0}, // 1
    {1.0, 1.0, 1.0} // 0
};

// we'll put the results here
double[] out = new double[4];

// here's what we WANT the results to be:
double[] expectedOut = new double[] { 0.0, 1.0, 1.0, 0.0 };
```

Now we build our network.

```
NEATNetwork net = neatInd.createNetwork();
int netDepth = net.maxDepth();
```

At this point we're ready to test it. We'll go through all combinations and see what the network produces:

```
// Load and activate the network on each input
for(int i = 0; i < in.length ;i++)
{
    net.loadSensors(in[i]);

    for(int relax = 0; relax < netDepth; relax++)
    {
        net.activate(state);
    }

    // we only have one output, at position 0, so let's get it
    out[i] = net.getOutputResults()[0];

    net.flush();
}
```

Finally we need to calculate the fitness. The NEAT XOR example actually has several different fitness-calculation methods. For our purposes we'll use sum squared error. And an ideal individual will be considered one in which all four of the results is less than 0.5 error.

```
double errorSum = 0;
for(int i = 0; i < out.length; i++)
    errorSum += (out[i] - expectedOut[i]) * (out[i] - expectedOut[i]);

double fitness = 4.0 - errorSum;

boolean ideal = true;
for(int i = 0; i < out.length; i++)
    if (Math.abs(out[i] - expectedOut[i]) > 0.5)
        { ideal = false; break; }
```

```

        ((SimpleFitness)neatInd.fitness).setFitness(state, fitness, ideal);
        neatInd.evaluated = true;
    }
}

```

Note that in this example, the measurement for the ideal individual is not the same as the measurement for fitness. This means that ideal individuals may vary in fitness. It also means that if we quit when we find an ideal individual, the end of run fitness may vary, which could really screw up statistical results if you're doing an experiment. You might add the parameter:

```
quit-on-run-complete = false
```

... to run until generations are terminated rather than when an ideal individual is discovered.

Next we need to specify a seed individual: recall that NEAT individuals are typically loaded from a seed. We do this as:

1. Whether the individual is evaluated: the boolean false (F)
2. The fitness for the individual: a double 0.0 (d0|0.0|)
3. The size of the link (gene) genome: an integer 3 (i3|)
4. Three link genes. Each gene contains:
 - (a) An input node ID as an integer, 1, 2, or 3 (i1| i2| i3|)
 - (b) An output node id as an integer: 4 (i4|)
 - (c) A weight as a double: 0.0 (d0|0.0|)
 - (d) Whether the link is recurrent: false (F)
 - (e) An innovation number as an integer, 1, 2, or 3 (i1| i2| i3|)
 - (f) A mutation number as a double: 0.0 (d0|0.0|)
 - (g) Whether the link is enabled: true (T)
5. Four node genes. Each gene contains:
 - (a) A node ID as an integer:
 - (b) A node type as an integer. Node types can be NEURON=0 or SENSOR=1 (i0| i1|)
 - (c) A node place as an integer. Node places can be HIDDEN = 0, INPUT = 1, OUTPUT=2, or BIAS=3 (i0| i1| i2| i3|)

Our default individual is stored as a subpopulation of size 1 and looks like this, stored in the file start.neatind. See if you can understand it:

```

Number of Individuals: i1|
Individual Number: i0|
Evaluated: F
Fitness: d0|0.0|
i3|
i1|i4|d0|0.0|Fi1|d0|0.0|T
i2|i4|d0|0.0|Fi2|d0|0.0|T
i3|i4|d0|0.0|Fi3|d0|0.0|T
i4|
i1|i1|i1|
i2|i1|i1|
i3|i1|i3|
i4|i0|i2|

```

Now we finish out with a parameter file. The file `ec/neat/neat.params` contains all the parameters we've discussed so far: we'll have that as our parent. So we make the file `ec/app/xor.params` like this as follows:

```
parent.0 = ../../neat/neat.params

pop.subpop.0.species.genome-size = 3
pop.subpop.0.file = start.neatind
pop.subpop.0.extra-behavior = wrap
eval.problem = ec.app.xor.XOR
pop.subpop.0.size = 150
generations = 100
```

Two parameters need explanation. To load the NEAT template (seed) individual, ECJ does this by loading the subpopulation. The subpopulation file, as discussed earlier, contains a single individual: but the subpopulation is 150 in size! This is handled by turning on the `wrap` option, which causes the individual in the file to be copied to the whole subpopulation. Thereafter NEAT will mutate that individual a bit, so they're all different.

5.6 Rulesets and Collections (The `ec.rule` Package)

Let's get one thing out of the way right now. Though we had rulesets in mind when we developed it, the `ec.rule` package isn't *really* for rulesets. Not only can the package be used for things other than rules, but it's not even sets: it's *collections* (or "bags" or "multisets") of arbitrary objects.

The representation defined by this package is fairly straightforward: an `ec.rule.RuleIndividual` contains one or more `ec.rule.RuleSets`, each of which contain zero or more `ec.rule.Rules`. A `Rule` is an abstract superclass which can contain anything you want. And that's about it.

Problem domains for which the `ec.rule` package is appropriate are often also good candidates for the variable-length lists found in the `ec.vector` package. You'll need to think about which is a better choice for you. Also beware that of the various representation packages in ECJ, `ec.rule` is definitely the least used and least tested. So its facilities are somewhat cruder than the others and it's possible you may see bugs.

Each level of the `ec.rule` package (individual, ruleset, rule) is a Prototype and has a Flyweight relationship with a central object special to that level (for a reminder on Flyweights, see Section 3.1.4). Specifically:

Object	In Flyweight Relationship With
<code>ec.rule.RuleIndividual</code>	<code>ec.rule.RuleSpecies</code>
<code>ec.rule.RuleSet</code>	<code>ec.rule.RuleSetConstraints</code>
<code>ec.rule.Rule</code>	<code>ec.rule.RuleConstraints</code>

The `ec.rule` package follows the same approach as the `ec.vector` package does when it comes to breeding: two basic breeding operators are provided (`ec.rule.breed.RuleCrossoverPipeline` and `ec.rule.breed.RuleMutationPipeline`) which simply call default mutation and crossover functions in the Individuals themselves. Thus to do more sophisticated breeding you have the choice of either overriding these functions or creating new breeding pipelines which perform more detailed operations on their own.

5.6.1 RuleIndividuals and RuleSpecies

`RuleIndividuals` and `RuleSpecies` are specified in parameters in the standard way:

```
pop.subpop.0.species = ec.rule.RuleSpecies
pop.subpop.0.species.ind = ec.rule.RuleIndividual
```

A `RuleIndividual` is a subclass of `Individual` which simply consists of an array of `RuleSets`:

```
public RuleSet[] rulesets;
```

Each RuleSet can be a different class. You'd think that the number and class of RuleSets was specified in the RuleSpecies (like in `ec.vector`). But for no good reason it's not the case: you specify them in the parameters for the prototypical individual, along these lines:

```
pop.subpop.0.species.ind.num-rulesets = 2
pop.subpop.0.species.ind.ruleset.0 = ec.rule.RuleSet
pop.subpop.0.species.ind.ruleset.1 = ec.app.myapp.MyRuleSet
```

Alternatively, you can use the RuleIndividual's default parameter base:

```
rule.individual.num-rulesets = 2
rule.individual.ruleset.0 = ec.rule.RuleSet
rule.individual.ruleset.1 = ec.app.myapp.MyRuleSet
```

Though for many applications you will probably just have a single RuleSet, and it'll probably just be an `ec.rule.RuleSet`:

```
pop.subpop.0.species.ind.num-rulesets = 1
pop.subpop.0.species.ind.ruleset.0 = ec.rule.RuleSet
```

5.6.2 RuleSets and RuleSetConstraints

A RuleSet contains an arbitrary number of Rules (`ec.rule.Rule`), anywhere between zero and up. It's largely your job to customize the breeding and initialization procedures appropriate to your problem to constraint the number and type of rules. They're defined here:

```
public Rule[] rules;
public int numRules;
```

Notice that the number of rules in the array may be *less* than the array size, that is, `numRules ≤ rules.length`. The rules themselves run from `rules[0] ... rules[numRules - 1]`. This is done because, like `ArrayList` etc., `rules` is variable in size and can grow and shrink. RuleSet contains a number of utility methods for manipulating the order and number of these rules:

ec.rule.RuleSet Methods

```
public int numRules()
```

Returns the number of rules in the RuleSet.

```
public void randomizeRulesOrder(EvolutionState state, int thread)
```

An auxiliary debugging method which verifies many features of the structure of the GP Tree and all of its GP Nodes. This method isn't called by ECJ but has proven useful in determining errors in GP Tree construction by various tree building or breeding algorithms.

```
public void addRule(Rule rule)
```

Adds the rule to the end of the ruleset, increasing the length of the RuleSet array as necessary.

```
public void addRandomRule(EvolutionState state, int thread)
```

Produces a new randomly-generated rule and adds it to the RuleSet. The Rule is created by cloning the prototypical Rule from the RuleSet's RuleSetConstraints, then calling `reset(...)` on it.

```
public Rule removeRule(int index)
```

Removes a rule located at the given index from the RuleSet and returns it. All rules are shifted down to fill the void.

```

public Rule removeRandomRule(EvolutionState state, int thread)
    Removes a random rule returns it. All rules are shifted down to fill the void.

public RuleSet[] split(int[] points, RuleSet[] sets)
    Breaks the RuleSet into n disjoint groups, then clones the rules in those groups and adds them to the respective
    sets, which must be provided in the given array. The first group of rules starts at 0 and ends below points[0]: this
    goes into sets[0]. Intermediate groups, which go into sets[i], start at points[i] and end below points[i+1]. The final
    group, which goes into sets[points.length], starts at points[points.length - 1] and continues to the end of the rule
    array. If points.length = 0, then all rules simply get put into sets[0]. Note that the size of sets must be one more
    than the size of points. The sets are returned.

public RuleSet[] split(EvolutionState state, int thread, RuleSet[] sets)
    For each rule in the RuleSet, clones the rule and adds the clone to a randomly chosen RuleSet from sets. Returns
    sets.

public RuleSet[] splitIntoTwo(EvolutionState state, int thread, RuleSet[] sets, double probability)
    For each rule in the RuleSet, clones the rule and, with the given probability, adds the clone to sets[0], else sets[1].
    Note that sets must be two in length.

public void join(RuleSet other)
    Copies the rules in the other RuleSet, then adds them to the end of this RuleSet.

public void copyNoClone(RuleSet other)
    Deletes all the rules in the RuleSet. Then places all the rules from the other RuleSet into this RuleSet. No cloning is
    done: both RuleSets now have pointers to the same rules.

```

Groups of RuleSets have a flyweight relationship with a RuleSetConstraints object. RuleSetConstraints is a Clique. You specify the number and class of RuleSetConstraints and assign each a unique name. Let's say you need two RuleSetConstraints objects, both instances of RuleSetConstraints itself. You'd write this:

```

rule.rsc.size = 2
rule.rsc.0 = ec.rule.RuleSetConstraints
rule.rsc.0.name = rsc1
rule.rsc.1 = ec.rule.RuleSetConstraints
rule.rsc.1.name = rsc2

```

RuleSetConstraints specify a number of constraints which guide the initialization and mutation of RuleSets, specifically:

- A distribution for choosing the number of Rules an initial RuleSet will have. This guides how the RuleSet's reset(...) method operates. The distribution can either be uniform with a minimum and maximum, or you can specify a histogram of possible size probabilities. We'll do the first case for Ruleset 0 and the second case for Ruleset 1 below:

```

# RuleSetConstraints 0 will have between 5 and 10 rules inclusive
rule.rsc.0.reset-min-size = 5
rule.rsc.0.reset-max-size = 10

# RuleSetConstraints 1 will have 0 to 4 rules with these probabilities...
rule.rsc.1.reset-num-sizes = 5
rule.rsc.1.size.0 = 0.1
rule.rsc.1.size.1 = 0.2
rule.rsc.1.size.2 = 0.2
rule.rsc.1.size.3 = 0.3
rule.rsc.1.size.4 = 0.4

```

- The probability of adding, deleting, and rearranging rules, when the RuleSet's mutate(...) method is called, typically by the BreedingPipeline ec.rule.RuleMutationPipeline. When this method is called, the Ruleset first mutates all of its rules by calling mutate(...) on them. Then it repeatedly flips a coin of a given probability: each time the coin comes up true, or until the number of rules is equal to the minimum number of initial rules as specified above, one rule is deleted. Afterwards it repeatedly flips a coin of another probability: each time the coin comes up true, or until the number of rules is equal to the maximum number of initial rules, one new rule is added at random. Finally, with a certain probability the rule ordering is shuffled. Here's some examples of specifying these probabilities:

```
rule.rsc.0.p-add = 0.1
rule.rsc.0.p-del = 0.1
rule.rsc.0.rand-order = 0.25

rule.rsc.1.p-add = 0.5
rule.rsc.1.p-del = 0.6
rule.rsc.1.rand-order = 0.0
```

Once you've specified a RuleSetConstraints, you then attach one to each RuleSet. For example:

```
pop.subpop.0.species.ind.ruleset.0.constraints = rsc2
pop.subpop.0.species.ind.ruleset.1.constraints = rsc1
```

... or alternatively use the default parameter base...

```
rule.individual.constraints = rsc2
```

Once set, you can access the constraints with the following method:

ec.rule.RuleSet Methods

```
public final RuleSetConstraints ruleSetConstraints(RuleInitializer initializer)
    Returns the RuleSet's RuleSetConstraints
```

RuleSetConstraints one method for choosing random initial values under the constraints above:

ec.rule.RuleSetConstraints Methods

```
public int numRulesForReset(RuleSet ruleset, EvolutionState state, int thread)
    Returns a random value from the initial (reset(...)) distribution, to use as the number of rules to initialize or reset the RuleSet.
```

Additionally, the various addition, deletion, and randomization probabilities can be accessed like this:

```
RuleSetConstraints rsc = myRuleSet.ruleSetConstraints((RuleInitializer)(state.init));
double addition = rsc.p_add;
double deletion = rsc.p_del;
double shuffling = rsc.p_randorder;
```

RuleSets also contain all the standard reading and writing methods, none of which you'll need to override unless you're making a custom RuleSet.

ec.rule.RuleSet Methods

```
public void printRuleSetForHumans(EvolutionState state, int log)
    Writes a RuleSet to a log in a fashion easy for humans to read.
```

```

public void printRuleSet(EvolutionState state, int log)
    Writes a RuleSet to a log in a fashion that can be read back in via readRule(...), typically by using the Code package.

public void printRuleSet(EvolutionState state, PrintWriter writer)
    Writes a RuleSet to a Writer in a fashion that can be read back in via readRule(...), typically by using the code
    package.

public void readRuleSet(EvolutionState state, LineNumberReader reader) throws IOException
    Reads a RuleSet written by printRuleSet(...) or printRuleSetToString(...), typically using the Code package.

public void writeRuleSet(EvolutionState state, DataOutput output) throws IOException
    Writes a RuleSet in binary fashion to the given output.

public void readRuleSet(EvolutionState state, DataInput input) throws IOException
    Reads a RuleSet in binary fashion from the given input.

```

5.6.3 Rules and RuleConstraints

RuleSetConstraints also contain the **prototypical Rule** for RuleSets adhering to a given constraints. RuleSets will clone this Rule to create Rules to fill themselves with. `ec.rule.Rule` is an abstract superclass which doesn't do anything by itself: you're required to subclass it to make the Rule into the kind of thing you want to create a collection of in your Ruleset.

The prototypical Rule is specified like this:

```

pop.subpop.0.species.ind.ruleset.0.rule = ec.app.MyRule
pop.subpop.0.species.ind.ruleset.1.rule = ec.app.MyOtherRule

```

You can get the prototypical rule like this:

```

RuleSetConstraints rsc = myRuleSet.ruleSetConstraints((RuleInitializer)(state.init));
Rule prototype = rsc.rulePrototype;

```

Each Rule has a flyweight-related RuleConstraints object, which is defined similarly to RuleSetConstraints (it's also a Clique). For example, to create a single RuleConstraints in the clique, you might say:

```

rule.rc.size = 1
rule.rc.0 = ec.rule.RuleConstraints
rule.rc.0.name = rc1

```

RuleConstraints are essentially blank: they define no special parameters or variables. You can use them however you see fit. If you don't really care, you can just make a single RuleConstraints object as above and assign it to your prototypical rules, such as:

```

pop.subpop.0.species.ind.ruleset.0.rule.constraints = rc1
pop.subpop.0.species.ind.ruleset.1.rule.constraints = rc1

```

...or use the default parameter base:

```

rule.rule.constraints = rc1

```

A Rule is abstract, and so has certain abstract methods which must be overridden, as well as others which *ought* to be overridden. First the required ones:

ec.rule.Rule Methods

```
public abstract int hashCode()
    Returns a hash code for the rule, based on value, suitable for weeding out duplicates.

public abstract int compareTo(Object other)
    Returns 0 if this Rule is identical in value to other (which will also be a Rule), -1 if this Rule is "less" than the other
    rule in sorting order, and 1 if the Rule is "greater" than the other rule in sorting order.

public abstract void reset(EvolutionState state, int thread)
    Randomizes the value of the rule.
```

Rules are Prototypes and so implement the `clone()`, `setup(...)`, and `defaultBase()` methods. You'll most likely need to override the `clone()` and `setup(...)` methods as usual. Additionally, you may want to override:

ec.rule.Rule Methods

```
public void mutate(EvolutionState state, int thread)
    Mutates the Rule in some way and with some probability. The default implementation simply calls reset(...),
    which is probably much too harsh.

public abstract int compareTo(Object other)
    Returns 0 if this Rule is identical in value to other (which will also be a Rule), -1 if this Rule is "less" than the other
    rule in sorting order, and 1 if the Rule is "greater" than the other rule in sorting order.

public abstract void reset(EvolutionState state, int thread)
    Randomizes the value of the rule.
```

Then there are the standard printing and reading methods. You'll need to override at least `printRuleToStringForHumans()`, and probably will want to override `toString()`. The others you can optionally override depending on the kind of experiments you're doing.

ec.rule.Rule Methods

```
public String toString()
    Writes the Rule to a String, typically in a fashion that can be read back in via readRule(...). You'll want to override
    this method or printRuleToString(). You probably want to use the Code package to write the rule out. You only
    really need to implement this method if you expect to write Individuals to files that will be read back in later.

public String printRuleToStringForHumans()
    Writes the Rule to a String in a fashion easy for humans to read. The default implementation of this method simply
    calls toString(). You'll probably want to override this method.

public void printRuleForHumans(EvolutionState state, int log)
    Writes a Rule to a log in a fashion easy for humans to read. The default implementation of this method calls
    printRuleToStringForHumans(), which you should probably override instead.

public String printRuleToString()
    Writes the Rule to a String, typically in a fashion that can be read back in via readRule(...). The default implemen-
    tation of this method simply calls toString(). You'll want to override this method or toString(). You probably want
    to use the Code package to write the rule out. You only need to implement this method if you expect to write
    Individuals to files that will be read back in later.

public void printRule(EvolutionState state, int log)
    Writes a Rule to a log in a fashion that can be read back in via readRule(...). The default implementation of this
    method calls printRuleToString(), which you should probably override instead.

public void printRule(EvolutionState state, PrintWriter writer)
    Writes a Rule to a Writer in a fashion that can be read back in via readRule(...). The default implementation of this
    method calls printRuleToString(), which you should probably override instead.
```

`public void readRule(EvolutionState state, LineNumberReader reader) throws IOException`
Reads a Rule written by `printRule(...)` or `printRuleToString(...)`, typically using the Code package. The default does nothing. You only need to implement this method if you expect to read Individuals from files.

`public void writeRule(EvolutionState state, DataOutput output) throws IOException`
Writes a Rule in binary fashion to the given output. The default does nothing. You only need to implement this method if you expect to read and write Rules over a network (such as the distributed evaluation or island models).

`public void readRule(EvolutionState state, DataInput input) throws IOException`
Reads a Rule in binary fashion from the given input. The default signals an error. You only need to implement this method if you expect to read and write Rules over a network (such as the distributed evaluation or island models).

5.6.4 Initialization

Basic Initialization works as follows:

1. The `RuleSpecies` method `newIndividual(EvolutionState, int)` produces a `RuleIndividual` by calling `super.newIndividual(...)`—cloning a `RuleIndividual` prototype—and then calling `reset(...)` on the resultant `RuleIndividual`.
2. The `RuleIndividual`'s `reset(...)` by default just calls `reset(...)` on each of the `RuleSets`.
3. A `RuleSet`'s `reset(...)` method calls `numRulesForReset(...)` on the `RuleSetConstraints` to pick a random number of rules to generate (see Section 5.6.2). It then produces an array of that size and fills it with rules cloned from the `RuleSetConstraint`'s prototypical `Rule`. Then it calls `reset(...)` on each of the `Rules`.
4. You are responsible for implementing a `Rule`'s `reset(...)` method.

You can of course intervene and modify any of these methods as you see fit.

5.6.5 Mutation

As in the case in the `ec.vector` package, the `ec.rule.breed.RuleMutationPipeline` class doesn't mutate rules directly, but rather calls a method on them to ask them to mutate themselves. The procedure is as follows:

1. The `RuleMutationPipeline` calls `preprocessIndividual(...)` on the `RuleIndividual`.
2. The `RuleIndividual`'s `preprocessIndividual(...)` method calls `preprocessRules(...)` on each of the `RuleSets`.
3. The `RuleSet`'s `preprocessRules(...)` method by default does nothing: override it as you like.
4. The `RuleMutationPipeline` then calls `mutate(...)` on the `RuleIndividual`.
5. The `RuleIndividual`'s `mutate(...)` method by default just calls `mutate(...)` on each of its `RuleSets`.
6. The `RuleSet`'s `mutate(...)` method does several modifications to the rules in the `RuleSet`, in this order:
 - (a) All the `Rules` in the `RuleSet` have `mutate(...)` called on them.
 - (b) A coin is repeatedly flipped of a certain probability (`p_del`), and each time it comes up true, a rule is deleted at random using `removeRandomRule(...)`. The individual will not shrink smaller than its specified minimum size.
 - (c) A coin is repeatedly flipped of a certain probability (`p_add`), and each time it comes up true, a rule is added at random using `addRandomRule(...)`. That method clones a new `Rule` from the prototypical `Rule`, then calls `reset(...)` on it. The individual will not grow larger than its specified maximum size.

- (d) With a certain probability (`p_randorder`), the order of the rules is shuffled using `randomizeRulesOrder(...)`.

The three probabilities (`p_del`, `p_add`, and `p_randorder`), and the minimum and maximum rule sizes, are discussed in Section 5.6.2, and are determined by `RuleSetConstraints` parameters, also discussed in that Section.

7. A Rule's `mutate(...)` method by default simply calls `reset(...)`, which is probably not what you want. You'll probably want a much more subtle mutation if any, and so will need to override this method.
8. You are responsible for implementing a Rule's `reset(...)` method.
9. Finally, the `RuleMutationPipeline` calls `postprocessIndividual(...)` on the `RuleIndividual`.
10. The `RuleIndividual`'s `postprocessIndividual(...)` method calls `postprocessRules(...)` on each of the `RuleSets`.
11. The `RuleSet`'s `postprocessRules(...)` method by default does nothing: override it as you like.

Often rules need to be in a carefully-constructed dance of constraints to be valid in an `Individual`. The intent of the `preprocessIndividual(...)`, `postprocessIndividual(...)`, `preprocessRules(...)`, and `postProcessRules(...)` methods is to give your `RuleIndividual` a chance to fix `RuleSets` that have been broken by crossover or mutation. The default implementation of these methods doesn't do much:

ec.rule.RuleSet Methods

`public void preprocessRules(EvolutionState state, int thread)`

A hook called prior to mutation or crossover to prepare for possible breakage of Rules due to the mutation or crossover event. The default implementation does nothing.

`public void postprocessRules(EvolutionState state, int thread)`

A hook called after to mutation or crossover to fix possible breakage of Rules due to the mutation or crossover event. The default implementation does nothing.

ec.rule.RuleIndividual Methods

`public void preprocessIndividual(EvolutionState state, int thread)`

Calls `preprocessRules(...)` on each `RuleSet` in the `Individual`.

`public void postprocessIndividual(EvolutionState state, int thread)`

Calls `postprocessRules(...)` on each `RuleSet` in the `Individual`.

5.6.6 Crossover

Unlike `RuleMutationPipeline`, the `ec.rule.breed.RuleCrossoverPipeline` performs direct crossover on two `RuleIndividuals`. Here is the procedure:

1. The `RuleCrossoverPipeline` calls `preprocessIndividual(...)` on each `RuleIndividual`.
2. The `RuleIndividual`'s `preprocessIndividual(...)` method calls `preprocessRules(...)` on each of the `RuleSets`.
3. The `RuleSet`'s `preprocessRules(...)` method by default does nothing: override it as you like.
4. For each pair of `RuleSets`, one per `RuleIndividual`...
 - (a) Each `RuleSet A` and `B` is split into two pieces, A_1 and A_2 (and B_1 and B_2) by calling `splitIntoTwo(...)`

- (b) A new RuleSet A' is formed from the union of A_1 and B_1 , and likewise, a new RuleSet B' is formed from the union of A_2 and B_2 .
 - (c) If A' and B' do not minimum and maximum size constraints (see Section 5.6.2), go to (a) and try again.
 - (d) Else A' and B' replace A and B respectively in each RuleIndividual.
5. Finally, the RuleCrossoverPipeline calls `postprocessIndividual(...)` on each RuleIndividual.
 6. The RuleIndividual's `postprocessIndividual(...)` method calls `postprocessRules(...)` on each of the RuleSets.
 7. The RuleSet's `postprocessRules(...)` method by default does nothing: override it as you like.

RuleCrossoverPipeline has a few parameters which guide its operation. First, any given Rule will migrate from one Individual's RuleSet to the other only with a certain probability. Second, the CrossoverPipeline can be set up to return only one child (tossing the second) rather than returning two. By default it returns both children. To set both of these parameters, let's say that the RuleCrossoverPipeline is the root pipeline for the species. We'd say:

```
pop.subpop.0.species.pipe = ec.rule.breed.RuleCrossoverPipeline
pop.subpop.0.species.pipe.crossover-prob = 0.1
pop.subpop.0.species.pipe.toss = true
```

It doesn't make any sense to have a rule crossover probability higher than 0.5. As usual, you could use the default parameter base as well:

```
rule.xover.crossover-prob = 0.1
rule.xover.toss = true
```

Chapter 6

Parallel Processes

ECJ has various built-in methods for parallelism, and they can be used in combination with one another:

- Multiple breeding and evaluation **threads**, already discussed in Section 2.4.
- **Distributed evaluation**: sending chunks of Individuals to remote computers to be evaluated. This is typically done in a generational fashion, but a variation of this is **asynchronous evolution**, in which Individuals are sent to multiple remote computers in a steady-state fashion. Additionally, remote computers can (given time) engage in a little evolutionary optimization of their own on the chunks they've received before sending them back. This is known as **opportunistic evolution**.¹
- **Island models**: multiple parallel evolutionary processes occasionally send fit individuals to one another.²

Warning ECJ's distributed evaluation and island models facilities use unencrypted network sockets to transfer individuals over a network. The individuals are not serialized, but individual pieces of them (ints, etc.) are written in binary format. Thus ECJ is theoretically vulnerable to injection hacks, and so if you plan to use this facility in more distributed form than a local cluster, you might consider adding an encrypted socket or using a VPN facility to be safe.

6.1 Distributed Evaluation (The `ec.eval` Package)

Distributed Evaluation is connects one **master** ECJ process with some N **slave** ECJ processes. The master handles the evolutionary loop, but when Individuals are evaluated, they are shipped off to the remote slaves to do this task. This way evaluation can be parallelized.

Distributed Evaluation is only useful if the amount of time you save by parallelizing evaluation exceeds the amount of time lost by shipping Individuals over the network (and sending at least Fitnesses back). Generally this means that evaluation needs to take a fair bit of time per Individual: perhaps several seconds.

There are two kinds of EvolutionState objects which can work with Distributed Evaluation:

- SimpleEvolutionState, which sends entire Populations off to be evaluated in parallel.
- SteadyStateEvolutionState, which sends individuals off to be evaluated one at a time, in a fashion called **asynchronous evolution** (discussed later).

¹ECJ's built-in distributed evaluation is meant for clusters. However, Parabon Inc. has developed a grid-computing version, called Origin, which runs on hundreds of thousands or even millions of machines. See the ECJ main website for more information.

²ECJ's built-in island models are meant for clusters. However, a version of ECJ was ported to run on top of the DR-EA-M system, a peer-to-peer evolutionary computation network facility developed from a grant in Europe. See the ECJ main website for more information.

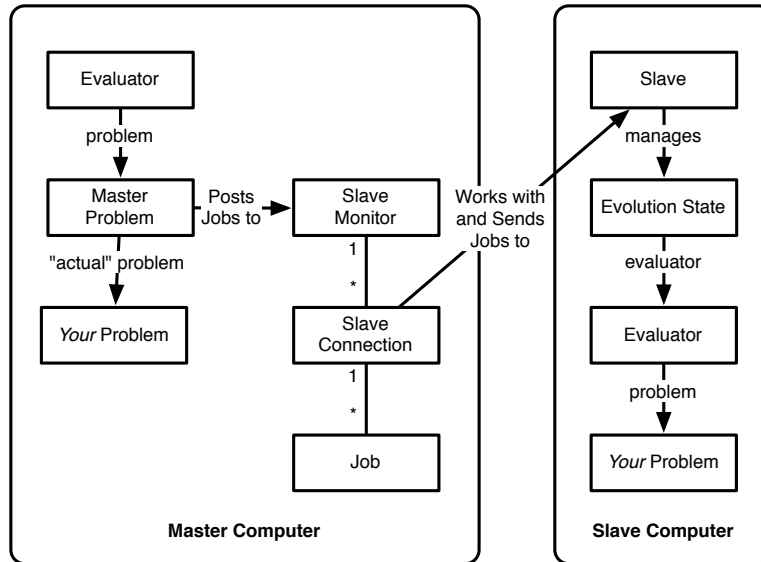

Figure 6.1 Layout of the Distributed Evaluation package.

6.1.1 The Master

To set up Distributed Evaluation, you first need to set up the Master. This is done just like a regular evolutionary computation process: but there are some additional parameters which must be defined. First, we must define the **master problem**, nearly always as `ec.eval.MasterProblem`. The presence of the master problem turns on distributed evaluation:

```
eval.masterproblem = ec.eval.MasterProblem
```

The `MasterProblem` is the interface that connects the distributed evaluation system to a regular evolutionary computation loop. When it is defined, ECJ replaces the `Problem` prototype with a `MasterProblem` prototype. The original `Problem` doesn't go away — it's rehung as a variable in the `MasterProblem`. Specifically, you can get to it like this:

```
Problem originalProblem = ((MasterProblem)(state.evaluator.p_problem)).problem;
```

When your evolutionary computation process wishes to evaluate one or more individuals, it hands them to the `MasterProblem`, which it thinks is the `Problem` for the application. But the `MasterProblem` doesn't send them to a clone of your underlying `Problem` but rather routes them to a `Slave`.

Slaves register themselves over the network with an object in the Master process called a `ec.eval.SlaveMonitor`, which maintains one `ec.eval.SlaveConnection` per `Slave` to communicate with the remote `Slave`. The `SlaveMonitor` listens in on a specific socket port for incoming `Slaves` to register themselves. You'll need to define this port (to something over 2000). Here's what's standard:

```
eval.master.port = 15000
```

Your `MasterProblem` will submit `Individuals` to the `SlaveMonitor`, which will in turn direct them to one of the `SlaveConnections`. `SlaveConnections` don't just ship off single `Individuals` to `Slaves` — that would be far too inefficient a use of network bandwidth. Instead, they often batch them up into **jobs** for the `Slave` to perform. Here's how you define the size of a job:

```
eval.masterproblem.job-size = 10
```

The default is 1, which is safe but maximally inefficient. The idea is to make the job large enough to pack Individuals into a network packet without wasting space. If your Individuals are large, then a large job size won't have any efficiency benefit. If they're very small, the job size will have a huge benefit.

You also need to keep the Slaves humming along, ideally by keeping the TCP/IP streams filled with waiting jobs queued up. Increasing this number can have a significant effect on performance. Here's a reasonable minimum:

```
eval.masterproblem.max-jobs-per-slave = 3
```

Again, the default is 1, which is safe but inefficient.

Warning! If you set these two parameters wrong, you may wind up sending all your individuals to just a few slaves, while the others sit by idly. Let's say that the value N is equal to the floor of the number of individuals in a subpopulation divided by the number of slaves. For example, if you have 100 individuals and 45 slaves, then $N = 2$. In general, you never want your `job-size` to be greater than N . Furthermore, if your `job-size` is set to some value M , you never want your `max-jobs-per-slave` to be greater than $\lfloor N/M \rfloor$. The safe (but potentially network-inefficient) settings are always 1 and 1 respectively.

ECJ would prefer to compress the network streams to make them more efficient. But it can't do it without the `jzlib/ZLIB` library, which you must install separately³ (see the ECJ main webpage or <http://www.jcraft.com/jzlib>). Once it's installed, you can turn it on like this:

```
eval.compression = true
```

Another warning! If you turn on compression in your master but not your slave (or vice versa), the slave will connect but then nothing will happen. You will not get any warning about your error.

Keep Your Master Single-Threaded Multi-threaded breeding is fine. But evaluation should be kept single-threaded, that is,

```
evalthreads = 1
```

Multi-threaded evaluation will *probably* work fine: but I'm not absolutely positive of it, and there's no use to multithreading when all you're doing is shipping jobs off-site. Play it safe.

6.1.2 Slaves

Slaves are started up on separate CPUs, often in different machines from the Master. You can have as many Slaves as you like: the more the merrier. The Slave class replaces `ec.Evolve` to handle its own startup, so you don't start up a Slave using the standard `ec.Evolve` procedure. Instead you'd type:

```
java ec.eval.Slave -file slave.params -p param=value ... (etc.)
```

The slave parameters must include all the evolutionary parameters and also all the master parameters (in fact, you might as well say something like...)

```
parent.0 = master.params
```

³Sure, Java has built-in compression routines. Unfortunately they're entirely broken for network streams: they don't support "partial flush", a critical item for sending stuff across networks. They're only really useful for compressing files on disks. It's a long-standing Java bug, and unlikely to get fixed in the foreseeable future.

Slaves set themselves up with their own nearly complete EvolutionState and Evaluator objects — enough to evaluate Individuals and also perform evolution if necessary. A slave distinguishes itself by setting a special internal parameter: `eval.i-am-slave = true`. You don't need to set this parameter — it's set programmatically by `ec.eval.Slave` when it's fired up. But you should be aware of it: it's used by `ec.Evaluator` to determine whether to replace the Problem with the MasterProblem (it needs to know if the process is a Master or a Slave, and since your Slave probably included the Master parameters — including the `eval.masterproblem` parameter — it looks confusingly like a Master). You could also use it yourself to determine if your code is presently being run on a Slave or not. This is occasionally useful:

```
ec.util.Parameter param = new ec.util.Parameter("eval.i-am-slave");
boolean amASlave = state.parameters.getBoolean(param, null, false);
```

The first thing a Slave needs to know is where the Master is so it can set itself up. This is done with something like this:

```
eval.master.host = 129.8.2.4
```

Remember that you'll also need the port (among other Master parameters!)

Next the Slave needs to know whether it should return entire Individuals or just the Fitnesses of those Individuals. Individuals are generally much bigger than Fitnesses, and if you only return Fitnesses you can cut your network traffic almost in half. The problem is that in some custom experiments your fitness evaluation procedure might modify the Individual (it depends on the nature of your experiment), and so you'd need to return it in that case. You'll need to state whether to return entire Individuals or not:

```
eval.return-inds = false
```

Slaves can come and go at any time dynamically. If new slaves show up, the Master will immediately start taking advantage of them. If a Slave disappears, the Individuals it was responsible for will be reassigned to another Slave.

Slaves can be multithreaded: they can process multiple individuals in parallel in the background as they come in. This is done with the standard parameter:

```
evalthreads = 4
```

This will create four threads on the Slave process to evaluate Individuals. Note that it makes no sense for this parameter to exceed the Master's `eval.masterproblem.job-size` parameter. Also, if you exceed the actual number of CPUs or cores allocated to your Slave process, it doesn't make much sense either. Last, Slaves are *not* multithreaded when evaluating Individuals with `GroupedProblemForm` (such as `coevolved` evaluation, see Section 7.1.2).

When you fire up a Slave, it will repeatedly try to connect to a Master process until it succeeds. This means you can start Slaves before you start the Master; or you can start them after you start the Master, it doesn't matter. Ordinarily when the Master dies (it finishes the EC process, or it bombs, or whatever) the Slaves will all terminate. But you can also set up Slaves to run in a **daemon mode**: when the Master terminates the Slave resets itself and waits for another Master to come online. Slaves in daemon mode also reset themselves if an error occurs on the Slave: perhaps a Java error in the user's fitness evaluation procedure, say, or if the virtual machine runs out of memory. In the case of out-of-memory errors, the Slave will make a good-faith attempt to reset itself, but if it cannot, it will quit.

By default slaves do not run in daemon mode: they are one-shot. To run in daemon mode, say:

```
eval.slave.one-shot = false
```

The default is "true" (that is, *not* daemon mode).

Warning! If you make your slave multithreaded, and run it in daemon mode, and an exception occurs while the slave is doing multithreaded evaluation, then the slave may reset without cleaning up the other threads: they may continue in the background.

You can give your slave a name which it and the master will use when printing out connection information. It's not at all necessary: you don't have to, in which case it'll make up a name consisting of its IP address and a unique number. To assign a name, you say:

```
eval.slave.name = MyName
```

If you would like to prevent the slave from writing anything to the screen, except in the case of a fatal error or exception, you can say:

```
eval.slave.silent = true
```

The default is "false".

6.1.3 Opportunistic Evolution

Slaves have the option of doing some evolutionary computation of their own, a procedure known as **opportunistic evolution** [28]. The procedure works like this:

1. The Master sends the Slave a large Job.
2. The Slave evaluates the Individuals in the Job.
3. The Slave has a maximum allotted time to evaluate the Individuals. If it has not yet exceeded this time, it treats the Job as a Population and does some evolution on the Individuals in the Population.
4. When the time is up, the Slave returns the most recent Individuals in the Population in lieu of the original Individuals. The new Individuals replace the old ones in the Master's evolutionary process. This means that the Slave cannot just return Fitnesses, but must return whole Individuals.

This procedure is turned on with:

```
eval.slave.run-evolve = true
```

You'll also need to specify the amount of time (in milliseconds) allotted to the Slave. Here's how you'd set it to six seconds:

```
eval.slave.runtime = 6000
```

Last, if you're doing opportunistic evolution, you **must** return whole Individuals, not just Fitnesses. After all, you could have entirely different individuals after running on the Slave. Thus you'll need to set:

```
eval.return-inds = true
```

The procedure for evolution is entirely specified by the Slave's parameters just as if it were specified in a regular ECJ process, including breeding and evaluation threads, etc. There's absolutely no reason the Slave can't have its own evolutionary algorithm that's *different* from the Master's evolutionary algorithm — just specify it differently in the Slave's parameters. The only thing that'd be required is that the Slave and the Master have exactly the same kinds of Individuals, Fitnesses, and Species in their Subpopulations.

Note that Opportunistic Evolution won't work with coevolution or other procedures which require GroupedProblemForm (Section 7.1.2). Additionally, although Steady-State Evolution (via Asynchronous Evolution, see Section 6.1.4) can work with Opportunistic Evolution in *theory*, it'd be quite odd to do so.

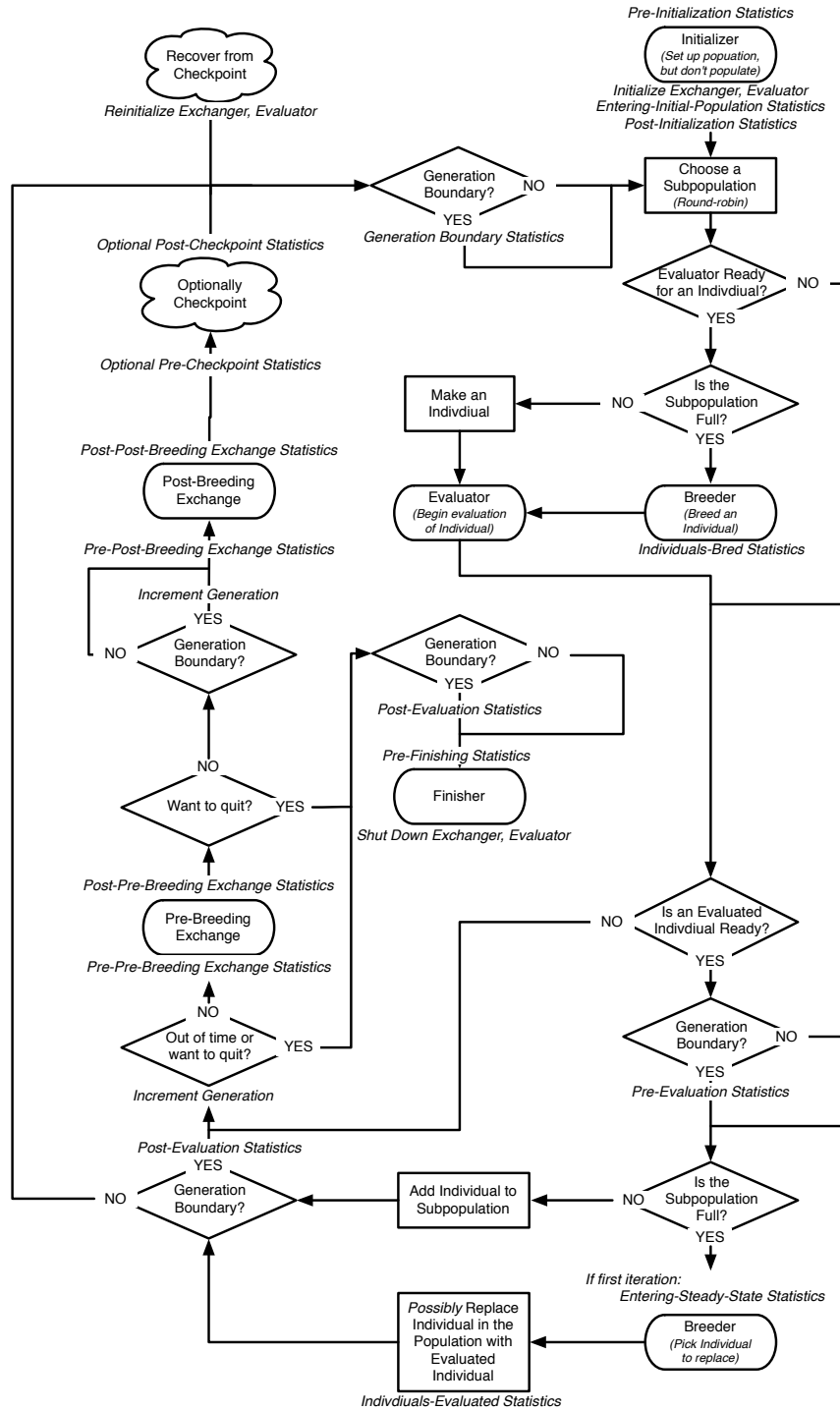

Figure 6.2 Top-Level Loop of ECJ's SteadyStateEvolutionState class, used for simple steady-state EC and Asynchronous Evolution algorithms. "First?" means to perform the Statistics whenever the Subpopulation in question is picking an Individual to displace for the very first time. (Each Subpopulation will do it once, but possibly at different times). A repeat of Figure 4.2.

6.1.4 Asynchronous Evolution

ECJ's distributed evaluation procedure works intuitively with generational methods (such as `ec.simple.SimpleEvolutionState`) but it also works nicely with Steady-State evolution (`ec.simple.SteadyStateEvolutionState`). This procedure is called **asynchronous evolution**. See [28] for more information.

The procedure is similar to Steady State Evolution, as discussed in Section 4.2. The Population starts initially empty. Then the algorithm starts creating randomly-generated Individuals and shipping them off to remote Slaves to be evaluated. If a Slave is available, the algorithm will generate an Individual for it to work on. When a Slave has finished evaluating an Individual and has returned it (or its Fitness), the Individual is then placed into the Population.

At some point the Population will fill up. At this point the algorithm shifts to "steady state" mode. When a Slave returns an Individual, and there's no space in the Population, the algorithm makes room by marking an existing Individual for death and possibly replacing it with the newcomer, just like it's done in Steady State Evolution (see Section 4.2 for details). And when a Slave becomes available, an Individual will no longer be created at random to give to it: rather, the Individual will be bred from the existing Population.

This procedure requires some careful consideration. First, note that at the point that the algorithm shifts to "steady state" mode, there are probably a large number of Individuals being evaluated on Slaves which were not bred from the Population but were created at random. Until those Individuals have made their way into the Population, we won't be in a true "steady state".

Second, Steady-State Evolution assumes the production of one Individual at a time: but distributed evaluation allows more than one individual per Job. This is reconciled as follows. when Steady-State Evolution starts up, it calls `prepareToEvaluate(...)` on the Problem (the `MasterProblem`) once. Thereafter whenever an individual is sent to the Problem to be evaluated, it calls `evaluate(...)`. Recall from Section 3.4.1 that this process does not require the Problem to immediately assign Fitness — it can bulk up Individuals for evaluation and is only required to provide a Fitness on or prior to a call to `finishEvaluating(...)`. However, Steady-State Evolution *never calls `finishEvaluating(...)`*. As a result, the distributed evaluator is free to assess Individuals in any order and any way it likes, and to take as long as it likes to assign them a Fitness. The distributed evaluator will wait for up to `job-size` worth of calls to `evaluate(...)`, then pack those Individuals together in one Job and ship them out to a remote Slave for evaluation. In "steady-state" mode, when the Individuals come back, they are placed in the Population, killing and replacing other individuals already there. Depending on the selection process for marking Individuals for death, it's entirely possible that an Individual newly placed into the Population may be immediately marked for death and replaced with another Individual from the same Job! You can get around this by setting the `job-size` and `max-jobs-per-slave` to as low as 1:

```
eval.masterproblem.job-size = 1
eval.masterproblem.max-jobs-per-slave = 1
```

...but of course this will make the network utilization poor.

Rescheduling Lost Jobs If you're doing generational evolution, then if a slave disappears you need the `SlaveMonitor` to reschedule the lost jobs, or else your population won't be fully evaluated. But that's not necessarily the case for Asynchronous Evolution. Here, if slave disappears along with its jobs, well, that's life. No big loss. Indeed, this is probably the *desired* behavior.

By default the `SlaveMonitor` reschedules its lost jobs. But you can turn off this behavior, so lost jobs just disappear into the ether, with:

```
eval.masterproblem.reschedule-lost-jobs = false
```

An Example For an example Asynchronous Evolution in action, see the files `ec/app/regression/asyncmaster.params` and `ec/app/regression/asynclslave.params`

6.1.5 The MasterProblem

The MasterProblem is where much of the magic lies in the interface between ECJ and the distributed evaluator, so it's worth mentioning some of its details.

Checkpointing and Synchronization To start, let's discuss how MasterProblem handles checkpointing. Evaluators have three methods which we didn't discuss in Section 3.4:

```
public void initializeContacts(EvolutionState state);
public void reinitializeContacts(EvolutionState state);
public void closeContacts(EvolutionState state, int result);
```

These methods are meant to assist in checkpointing with remote slaves. They in turn call similar methods in the prototypical Problem:

```
public void initializeContacts(EvolutionState state);
public void reinitializeContacts(EvolutionState state);
public void closeContacts(EvolutionState state, int result);
```

result will be one of EvolutionState.R.FAILURE (the most common case) or EvolutionState.R.SUCCESS (which only happens if the Evaluator in this process or some external process found the ideal individual).

The default implementation of these Problem methods does nothing at all. But in MasterProblem these methods are used to handle reconnection of Slaves after a checkpoint recovery. The first two methods create both a new SlaveMonitor. The final method shuts down the monitor cleanly.

Asynchronous Evolution MasterProblem also has special methods used only by Steady-State Evolution (and thus Asynchronous Evolution):

ec.eval.MasterProblem Methods

```
public boolean canEvaluate()
```

Returns true if a Slave is available to take an Individual.

```
public boolean evaluatedIndividualAvailable()
```

Returns true if a Slave has a completed Individual waiting to be introduced to the Population.

```
public QueueIndividual getNextEvaluatedIndividual()
```

Blocks until an Individual is available from a Slave. Then returns it as an `ec.steadystate.QueueIndividual`. A `QueueIndividual` is a very simple class which just contains the Individual and the Subpopulation that the Individual should be introduced into. It has the following instance variables:

```
public Individual ind;
public int subpop;
```

Batching up Jobs MasterProblem implements all the methods defined in SimpleProblemForm and GroupedProblemForm (Section 7.1.2). Additionally, MasterProblem overrides common Problem methods and handles them specially:

ec.eval.MasterProblem Methods

```
public void prepareToEvaluate(EvolutionState state, int threadnum)
```

Creates a new queue of Individuals who are out waiting to be sent to be processed.

```
public void finishEvaluating(EvolutionState state, int threadnum)
```

Sends all Individuals presently in the queue out in one or more Jobs. Then waits for all slaves to complete evaluation of all Individuals.

Most Evaluators instruct Problems to evaluate a sequence of Individuals by first calling `prepareToEvaluate(...)`, then repeatedly calling `evaluate(...)`, then finally calling `finishEvaluating(...)`. `MasterProblem` takes advantage of this as follows. When `prepareToEvaluate(...)` is called, `MasterProblem` creates a list in which to put Individuals. `evaluate(...)` does not actually evaluate individuals: instead, individuals are simply added to the list. When enough individuals have been added to the queue to form one Job, the Job is queued up to be submitted to the next available Slave. When `finishEvaluating(...)` is called, any remaining individuals in the list are bundled together in a final Job and sent to a Slave. Then `finishEvaluating(...)` waits until all the Jobs have been completed before it returns.

When the `GroupedProblemForm` form of `evaluate(...)` is called (such as from a coevolutionary evaluator), the Individuals passed to that call are treated as a single Job and shipped off immediately—that is, there is no queue. However, `evaluate(...)` again does not wait for results to come back. The waiting again happens when `finishEvaluating(...)` is called.

There are certain Evaluators which do call `prepareToEvaluate(...)` or `finishEvaluating(...)`, but instead just repeatedly call `evaluate(...)`. This is meant for processes which cannot delay the evaluation of individuals in an `evaluate(...)` before the next `evaluate(...)` is called. For example, certain competitive coevolutionary processes may require a serial evaluation of this kinds. In this case, a call to `evaluate(...)` will cause `MasterProblem` to simply ship off the Individual or Individuals to evaluate as a single job, wait for the result, and return it. Perhaps this isn't the best use of massive parallelism!

Sending Initialization Data from the Master to the Slaves `MasterProblem` has one additional feature: three methods you can override such that, whenever a Slave is started up, you are given the chance to send one-time data from the Master to the Slave, perhaps to initialize some variables you need your Slave to know. Note that this facility is untested and may be somewhat fragile: we suggest that before you use this facility you consider instead placing the data in a file that each Slave can read.

Here's how it works. You begin by declaring a special subclass of `MasterProblem`—let's call it `ec.app.myapp.MyMasterProblem`. Then you must tell ECJ that you're using it (on both sides, master and slave) with something like this:

```
eval.masterproblem = ec.app.myapp.MyMasterProblem
```

An instance of this `MasterProblem` subclass is used by the Master. When a Slave shows up, the Master will call the method `sendAdditionalData(...)` on that instance to give you the chance to send data down the stream to the Slave before any evaluation occurs. The Slave receives this data by calling the method `receiveAdditionalData(...)` on a dummy instance of this same subclass. This dummy instance will not be used for any purpose except to handle the data reception. That method must store away the transferred data, typically as instance variable in your subclass which you have created for this purpose. Finally, each time the Slave creates a new `EvolutionState` (and it may do so many times), it calls `transferAdditionalData(...)` on that dummy instance to give it a chance to modify and set up `EvolutionState` appropriately to reflect the data it had received from the Master.

`sendAdditionalData(...)` will be called once on the Master for each Slave that shows up. `receiveAdditionalData(...)` will only be called once on the Slave side. `transferAdditionalData(...)` may be called multiple times on the Slave side, every time a new `EvolutionState` is loaded and set up. It is entirely up to you to handle the protocol for sending and receiving this data: if you mess up (write more data than you read on the other side, say), it's undefined what'll happen. Probably something bad.

ec.eval.MasterProblem Methods

```
public void sendAdditionalData(EvolutionState state, DataOutputStream dataOut)
```

Called from the SlaveMonitor's `accept()` method to optionally send additional data to the Slave via the `dataOut` stream. By default it does nothing.

```
public void receiveAdditionalData(EvolutionState state, DataInputStream dataIn)
```

Called on a dummy MasterProblem by the Slave. You should use this method to store away received data via the `dataIn` stream for later transferring to the current EvolutionState via the `transferAdditionalData(...)` method. You should NOT expect this MasterProblem to be used for by the Slave for evolution (though it might). By default this method does nothing, which is the usual situation. The EvolutionState is provided solely for you to be able to output warnings and errors: do not rely on it for any other purpose (including access of the random number generator or storing any data).

```
public void transferAdditionalData(EvolutionState state)
```

Called on a dummy MasterProblem by the Slave to transfer data previously loaded via `receiveAdditionalData(...)` to a running EvolutionState at the beginning of evolution. This method may be called multiple times if multiple EvolutionStates are created. By default this method does nothing, which is the usual situation. Unlike in `receiveAdditionalData(...)`, the provided EvolutionState is "live" and you can set it up however you like.

6.1.6 Noisy Distributed Problems

Sometimes your fitness function is noisy: the same individual will get different fitness values depending on some degree of randomness. An easy way to deal with this is to run the same individual for some N trials inside your Problem instance and to take the median or mean or whatnot, and use that as your fitness.

This works fine in a single-CPU setting, but in a parallel setting there's a gotcha. Let's say you have 100 parallel machines available to you but you have a population size of 20. You'd like to do 5 trials for each individual, and trials are not cheap. If you farmed out individuals using the distributed evaluator and a Problem subclass which did 5 trials internally, only 20 machines would be used, and they'd be expected to run 5 trials each. What you want to do is run one trial on each of the machines. But because of the way MasterProblem is set up, this won't work.

ECJ has a hack that you can use in this situation. SimpleEvaluator has the parameters:

```
eval.num-tests = 5
% Other options are: median, best
eval.merge = mean
```

This tells the SimpleEvaluator to test each individual 5 times and set its fitness value to their mean. How does it do this? By temporarily modifying the Subpopulation.

If your Subpopulation presently has 20 individuals in it, and you want to test each 5 times, SimpleEvaluator will replace this Subpopulation with a copy which has 100 individuals in it. These 100 individuals are 5 clones each of the original 20. Then SimpleEvaluator evaluates this new population (which causes the distributed evaluation system to farm them out to potentially 100 machines).

After all the fitnesses have come back, SimpleEvaluator merges the fitnesses of the 5 clones together to form a single fitness and sets the original individual's fitness to that merged value. The legal merge settings are `mean`, `median`, and `best`. Finally, SimpleEvaluator restores the original Subpopulation.

This means that if you have a custom Subpopulation subclass, it needs to deal gracefully with being copied and having its individuals array extended. In general this is probably the case but you should be warned.

Also, in this situation, the number of individuals being evaluated is *smaller* than the number of machines available. Thus you will need to turn off ECJ features which bulk up multiple individuals per job, and multiple jobs per slave. Set these to 1:

```
eval.masterproblem.job-size = 1
eval.masterproblem.max-jobs-per-slave = 1
```

A note about merging and multiobjective optimization. Multiobjective Fitness classes can do merging, but only using `mean`. The median and best options will throw exceptions. When a multiobjective fitness undergoes merging, it's essentially forming the centroid of the merged fitnesses. Merging is okay for subclasses like SPEA2 or NSGA-II's fitness classes because it'd done *before* their auxiliary fitness information is computed.

There's no equivalent to this hack in Asynchronous Evolution: you'll just have to ask a machine to test the individual 5 times.

6.2 Island Models (The `ec.exchange` Package)

In addition to Distributed Evaluation, ECJ supports Island Models: separate ECJ processes ("islands") which connect over the network and occasionally hand highly-fit Individuals to one another. This facility is handled by an Exchanger called `ec.exchange.IslandExchange` which ships individuals off to other islands immediately before breeding, and immediately after breeding brings in new individuals provided it by other islands. You'll run your separate islands as ordinary processes.

Most of the issues in Island models surround the particular topology being chosen. Which islands will send Individuals to which other islands? How many at a time? How often? Are Individuals sent synchronously or asynchronously? Etc. ECJ manages all topology and connection parameters via a special ECJ process called the **island model server**. Each island will connect to and register itself with the server. When the islands have all connected, the server will tell them which islands need to hook up to which other islands and how. After the islands have hooked up, they're given the go-ahead to start their evolutionary processes. If the islands are acting synchronously, each generation will wait for the server to give them the go-ahead to continue to the next generation; this go-ahead only occurs after all islands have finished the previous generation. Finally, when an island discovers an optimal individual, it will signal the server to let the other islands know (so they can shut down).

As you can see, the server really does little more than tell the islands how to connect and acts as a referee. Thus it's actually a very lightweight process. You can run the server either as its own process like this:

```
java ec.exchange.IslandExchange -file server.params -p param=value ... (etc.)
```

...or an ECJ island can also do double-duty, serving as the server as well. All islands, whether ordinary islands or double-duty island-server combos, are fired up in the same standard ECJ fashion:

```
java ec.Evolve -file island.params -p param=value -p param=value ... (etc.)
```

...or (as usual):

```
java ec.Evolve -checkpoint myCheckpointFile.gz
```

A double-duty island-server combo would differ from a plain island solely in the parameters it defines: it'd need server parameters in addition to client parameters.

Mixing Island Models, Threading, and Distributed Evaluation There's absolutely no reason you can't create an unholy union of Island Models and Distributed Evaluation. For example, it's perfectly reasonable to have an Island Model where each island maintains its own pool of Slaves to do distributed evaluation. It'd be a lot of parameter files though! Island Models also work perfectly fine in a multithreaded environment.

6.2.1 Islands

You set up an ECJ process as an island by defining a special Exchange object for it:

```
exch = ec.exchange.IslandExchange
```

IslandExchange maintains the island's **mailbox**. Prior to breeding, the IslandExchange procedure will send some fit individuals off to mailboxes of remote islands. The procedure for selecting Individuals is defined along these lines:

```
exch.select = ec.select.TournamentSelection
```

Obviously this selection procedure may require its own parameters, such as (in this example):

```
exch.select.size = 2
```

After breeding, the IslandExchange will empty its own mailbox and introduce into the Population all of the Individuals contained therein. These Individuals will displace some of the recently-bred Individuals, which never get a chance to be selected.⁴ The selection method for picking the Individuals to die and be displaced is defined as:

```
exch.select-to-die = ec.select.RandomSelection
```

If this parameter isn't defined, individuals are picked at random. Again, as this is a selection operator, it may have its own parameters.

An Island needs to know where the Server is so it can register itself, and the socket port on which the server is listening, for example:

```
exch.server-addr = 128.2.30.4  
exch.server-port = 8999
```

When an Island registers itself with the Server, it'll tell it two things. First, it'll tell the Server the island's **name**, a String which uniquely identifies the island (and by which the Server looks up topology information for the island). Second, it'll tell the Server the socket port on which it'll receive incoming Individuals from other islands. Let's say that you're creating an island called StatenIsland. You might specify the following:

```
exch.id = StatenIsland  
exch.client-port = 9002
```

Note that the client socket port should be (1) higher than 2000 and (2) different from other client ports, and the server port, if they're running on the same machine or in the same process. You'll also probably want to have compressed network streams. Like was the case in Distributed Evaluation, this can't be done without the jzlib/ZLIB library, which you must install separately (see the ECJ main webpage or <http://www.jcraft.com/jzlib>). This is because Java's compression facilities are broken. Once this library installed, you can turn it on like this:

```
exch.compression = true
```

Be certain to give your island a unique random number seed different from other islands! Don't set the seed to `time`, since it's possible that two islands will have the same seed because they were launched within the one millisecond of one another. I'd hard-set the seed on a per-island basis.

```
seed.0 = 5921623
```

If your islands share the same file system, you'll want to make sure they don't overwrite each other's statistics files etc. To do this, for example, StatenIsland might change its statistics file name to:

⁴Life's not fair.

```
stat.file = $statenisland.stat
```

If you have multiple Statistics files you'll need to change all of them; the same goes for other files being written out. Also, if you are checkpointing, and your islands might overwrite each others' checkpoint files, you need to change the checkpoint prefix on a per-island basis. For example:

```
checkpoint-prefix = statenisland
```

... or alternatively change the directory in which checkpoint files are written on a per-island basis:

```
checkpoint-directory = /tmp/statenisland/
```

Last, you can cut down on the verbosity of the islands by setting...

```
exch.chatty = false
```

6.2.2 The Server

The Server holds all the parameters for setting up the island topology. But first we must clue your ECJ process into realizing that it is a Server in the first place. This is done with:

```
exch.i-am-server = true
```

Next we need to state how many islands are in the island model graph:

```
exch.num-islands = 3
```

As discussed in Section 6.2.1, each island has a unique name (id). Here you will state which island in your graph has which id:

```
exch.island.0.id = StatenIsland
exch.island.1.id = ConeyIsland
exch.island.2.id = EllisIsland
```

Each island has some number of connections *to* other islands (the islands it'll send Individuals, or *migrants*, to). In this example, we'll say that StatenIsland sends migrants to ConeyIsland, which sends migrants to EllisIsland, which sends migrants to both StatenIsland and ConeyIsland:

```
exch.island.0.num-mig = 1
exch.island.0.mig.0 = ConeyIsland
exch.island.1.num-mig = 1
exch.island.1.mig.0 = EllisIsland
exch.island.2.num-mig = 2
exch.island.2.mig.0 = StatenIsland
exch.island.2.mig.1 = ConeyIsland
```

StatenIsland and ConeyIsland send 10 migrants to each of the islands they're connected to. But we want EllisIsland to send 50 migrants to each of the (two) islands it's connected to:

```
exch.island.0.size = 10
exch.island.1.size = 10
exch.island.2.size = 50
```

Alternatively you can use a default parameter base of sorts:

```
exch.size = 10
```

Each island has a maximum mailbox capacity: if there is no room, further immigrants will be dropped and disappear into the ether. You should make your mailbox big enough to accept immigrants at a reasonable rate, but not so large that in theory they could entirely overwhelm your population! I suggest a mailbox three or four times the size of the expected immigrants. How about 100 or 200?

```
exch.island.0.mailbox-capacity = 200
exch.island.1.mailbox-capacity = 200
exch.island.2.mailbox-capacity = 200
```

Alternatively you can use a default parameter base of sorts:

```
exch.mailbox-capacity = 200
```

Last you'll need to stipulate two additional parameters on a per-island basis: the **start-generation** (in which generation the island will start sending Individuals out) and **modulus** (how many generations the island will wait before it sends out another batch of Individuals). These are mostly set to maximize network utilization: perhaps you may wish the islands to send out individuals at different times so as not to clog your network, for example. Here we'll tell each island to send out individuals every three generations, but to start at different initial generations so to be somewhat staggered:

```
exch.island.0.mod = 3
exch.island.1.mod = 3
exch.island.2.mod = 3
exch.island.0.start = 1
exch.island.1.start = 2
exch.island.2.start = 3
```

Alternatively you can use a default parameter base of sorts:

```
exch.mod = 3
exch.start = 2
```

6.2.2.1 Synchronicity

Island models can be either **synchronous** or **asynchronous**. In a synchronous island model, islands wait until they all have reached the next generation before sending immigrants to one another. In the asynchronous island model, islands go at their own pace and send immigrants whenever they feel like it. This means that one evolutionary process on one computer may run much faster than another one (good, because it doesn't waste resources waiting for the other one to catch up) but it may overwhelm the other process with multiple generations of immigrants before the other process can get around to processing them (usually bad). Generally speaking asynchronicity is preferred — and is the default setting.

If for some reason you want to turn on synchronicity, you do this:

```
exch.sync = true
```

Note that the modulo and start-generation of islands results in a predictable behavior for synchronous island models: but since asynchronous islands can go at their own pace, the modulo and start-generation happen when they happen for each island.

Note too that because asynchronous island models go at their own pace, and are subject to the whims of the speed of the operating system and the CPU time allotted to the process, there's no way to guarantee replicability.

6.2.3 Internal Island Models

ECJ's Internal Island Model facility simulates islands using separate Subpopulations: each Subpopulation is an island, and occasionally highly fit Individuals migrate from Subpopulation to Subpopulation. Like any other Exchanger, the Internal Island Model facility takes Individuals from other Subpopulations immediately before Breeding, stores them, and then introduces them into their destination Subpopulations immediately after Breeding.

There are four important things to note about this facility:

- Obviously each Subpopulation must have identical Species and Individual and Fitness prototypes.
- Internal Island Models are always synchronous.
- Because they use the Subpopulation facility, Internal Island Models are incompatible with any other ECJ procedure which relies on Subpopulations: notably coevolution.
- Because they define an Exchanger, Internal Island Models are incompatible with any other ECJ procedure which uses an Exchanger: in particular, you can't mix Internal Island Models with regular Island Models!

Why would you use Internal Island Models? I think mostly for academic purposes: to study and simulate synchronous Island Models without having to rope together a bunch of machines. You could also use Internal Island Models to run N evolutionary processes in parallel — just set the number of immigrants to zero.

Internal Island Models depend solely on a specific Exchanger, `ec.exchange.InterPopulationExchange`. To build an Internal Island Model, you first define three subpopulations and their species, individuals, breeding pipelines, the whole works, using a standard generational algorithm. Then you define the exchanger:

```
exch = ec.exchange.InterPopulationExchange
```

Let's say you have four Subpopulations acting as islands. You'll first need to stipulate the Selection Method used to select individuals to migrate to other Subpopulations and the Selection Method used to kill Individuals to make way for incoming immigrants:

```
exch.subpop.0.select = ec.select.TournamentSelection
exch.subpop.1.select = ec.select.TournamentSelection
exch.subpop.2.select = ec.select.TournamentSelection
exch.subpop.3.select = ec.select.TournamentSelection
exch.subpop.0.select-to-die = ec.select.RandomSelection
exch.subpop.1.select-to-die = ec.select.RandomSelection
exch.subpop.2.select-to-die = ec.select.RandomSelection
exch.subpop.3.select-to-die = ec.select.RandomSelection
```

If you don't define a selection method for death, ECJ will assume you mean to select individuals randomly. Alternatively you can use the default parameter base:

```
exch.select = ec.select.TournamentSelection
exch.select-to-die = ec.select.RandomSelection
```

Remember that these selection operators may have their own parameters. For example, we may wish to say (for some reason):

```
exch.subpop.0.select.size = 2
exch.subpop.1.select.size = 2
exch.subpop.2.select.size = 7
exch.subpop.3.select.size = 7
```

Otherwise the selection operators will rely on their default parameters. **Note:** recall that these default parameters are *not* based on the Exchanger's default parameter base. That is, they're `select.tournament.size` and *not* `exch.select.size`. I strongly suggest using non-default parameters.

Next you need to state the number of immigrants sent at a time; the first generation in which they'll be sent; and the modulus (the interval, in terms of generations, between successive migrations). These are basically the same as the standard Island Model. The parameters might look like this:

```
exch.subpop.0.size = 5
exch.subpop.1.size = 5
exch.subpop.2.size = 5
exch.subpop.3.size = 15
exch.subpop.0.start = 1
exch.subpop.1.start = 2
exch.subpop.2.start = 3
exch.subpop.3.start = 4
exch.subpop.0.mod = 8
exch.subpop.1.mod = 8
exch.subpop.2.mod = 8
exch.subpop.3.mod = 8
```

It's here where you could convert these to separate independent evolutionary processes: just set the `size` parameter to 0 for all subpopulations. Anyway, you can also use default parameter bases for these:

```
exch.size = 5
exch.start = 1
exch.mod = 8
```

Now we need to define the topology. For each island we'll define the number of Subpopulations it sends migrants to, and then which ones. Imagine if Subpopulation 2 sent migrants to everyone else, but the other Subpopulations just sent migrants to Subpopulation 2. We would define it like this:

```
exch.subpop.0.num-dest = 1
exch.subpop.0.dest.0 = 2
exch.subpop.1.num-dest = 1
exch.subpop.1.dest.0 = 2
exch.subpop.2.num-dest = 3
exch.subpop.2.dest.0 = 0
exch.subpop.2.dest.1 = 1
exch.subpop.2.dest.2 = 3
exch.subpop.3.num-dest = 1
exch.subpop.3.dest.0 = 2
```

Last, Internal Island Models tend to be verbose. To make them less chatty, you can say:

```
exch.chatty = false;
```

Reminder It's laborious to write a zillion parameters if you have large numbers of subpopulations in your internal island model experiments. You can greatly simplify this process using the `pop.default-subpop` parameter (see Section 3.2.1).

6.2.4 The Exchanger

In Section 3.6 we talked about various basic Exchanger methods. But three were not discussed, mostly because they're only used for Island Models (not even Internal Island Models). They are:

```

public void initializeContacts(EvolutionState state);
public void reinitializeContacts(EvolutionState state);
public void closeContacts(EvolutionState state, int result);

```

If these look similar to the methods in Section 6.1.5, it's with good reason. Their function is to set up networking connections, re-establish networking connections after restarting from a checkpoint, and shut down networking connections in a clean way. `IslandExchange` implements them but not `InterPopulationExchange`.

Additionally, prior to migrating an `Individual` to another island, `Exchangers` typically call a hook you can override to modify that `Individual` or replace it with some other `Individual`:

```

protected Individual process(EvolutionState state, int thread, String island,
                             int subpop, Individual ind);

```

There are various reasons you might do this: perhaps the islands have different representations for their individuals or fitness classes, for example, requiring a conversion before you send migrants off.

This method has two parameters which require explanation. The island is the id of the island that will receive the `Individual`, or null if there is no such island (as is the case for `InterPopulationExchange`). The subpop is the destination subpopulation of the `Individual` (particularly important in `InterPopulationExchange`).

To assist you in your processing, `IslandExchange` provides an additional method which is useful to call inside the process method:

```

public int getIslandIndex(EvolutionState state, String island);

```

This method returns the index in the parameter database of the island referred to by id, or `IslandExchange.ISLAND_INDEX_LOOKUP_FAILED`.

The purpose of this method is to allow islands to look up information, typically stored in a parameter database, about the islands they're about to send migrants to, so as to convert individuals in a way appropriate to those islands, perhaps. To take advantage of this method, you'd need to make sure that the server's island exchange parameters are also in each client's database. For example, let's say that your id is "GilligansIsland", and in the parameter database (which again the client must have) we have the following parameters in the server database file:

```

exch.num-islands = 8
...
exch.island.1.id = GilligansIsland
exch.island.1.num-mig = 3
exch.island.1.mig.0 = SurvivorIsland
exch.island.1.mig.1 = EllisIsland
exch.island.1.mig.2 = FantasyIsland
exch.island.1.size = 4
exch.island.1.mod = 4
exch.island.1.start = 2
exch.island.1.mailbox-capacity = 20
# this is just made up
exch.island.1.is-gp-island = true
...

```

(Note the last nonstandard parameter, which I made up for purposes of this example.) We begin by also including these parameters in each island's database file. We are about to send some migrants to `GilligansIsland` (the name passed into `process(...)`). To look up information about this island, we can use `getIslandIndex(...)` to discover that `GilligansIsland` is island number 1 in our parameter database. This makes it easy for us to look up other information we've stashed there to tell us how we should process our island:

```

protected Individual process(EvolutionState state, int thread, String island, int subpop, Individual ind)

```

```

{
int index = getIslandIndex(state, island);
if (index == ISLAND_INDEX_LOOKUP_FAILED) // uh oh
    state.output.fatal("Missing island index for " + island);

Parameter param = new Parameter("exch.island." + index + ".is-gp-island");
if (!state.parameters.exists(param)) // uh oh
    state.output.fatal("Missing parameter for island!", param, null);

boolean isGPisland = getBoolean(param, null, false);
if (isGPisland)
    {
    // process the individual in some way because it's going to a "GP Island" or whatever
    }
}

```

This method isn't necessary (nor provided) for `InterPopulationExchange` since it doesn't really do "islands" per se so much as exchanges between subpopulations. In this case, the `process(...)` method has told us what subpopulation we'll be sending the individual to and we have direct access to it. For example, we might do this:

```

protected Individual process(EvolutionState state, int thread, String island, int subpop, Individual ind)
{
if (state.population.subpops.get(subpop).species instanceof ec.gp.GPSpecies)
    {
    // convert to a GP individual, or whatever
    }
}

```

Chapter 7

Additional Evolutionary Algorithms

7.1 Coevolution (The `ec.coevolve` Package)

The coevolution package is meant to provide support for three kinds of Coevolution:

- One-Population Competitive Coevolution
- Two-Population Competitive Coevolution
- N-Population Cooperative Coevolution

Coevolution differs from evolutionary methods largely in how evaluation is handled (and of course, by the fact that there are often multiple subpopulations). Thus the classes in this package are basically Problems and Evaluators. The first form of Coevolution is provided by the `ec.coevolve.CompetitiveEvaluator` class. The second two are made possible by the `ec.coevolve.MultiPopCoevolutionaryEvaluator` class.

7.1.1 Coevolutionary Fitness

Coevolution is distinguished by its evaluation of Individuals not separately but in groups, where the Fitness of an Individual depends on its performance in the **context** of other Individuals (either competing with them or working with them towards a common goal). For this reason, coevolution typically involves evaluating an Individual multiple times, each time with a different set of other Individuals, and then computing the Fitness based on these multiple **trials**.

To assist in this procedure, the `ec.Fitness` class has two auxiliary variables:

```
public ArrayList trials = null;
public Individual[] context = null;
```

The first variable (`trials`) is available for you to maintain the results of each trial performed. Later on you will be asked to compute the final fitness of an individual, and at this point you can use this variable to do the final calculation. The variable is initially null, and after fitness is assessed it will be reset to null again. You are free to use this variable as you like (or ignore it entirely), Most commonly you'd store each trial in the `trials` variable as a `java.lang.Double`, with higher values being considered better. You're free to do something else, but if you do, be sure to read Section 7.1.5 first. **Even if your trials are not `java.lang.Double`, they must be immutable: their internals cannot be modified, so they can be pointer-copied and not just cloned.**

The second variable (`context`) is available for you to maintain the context of the best trial discovered for the Individual. It's typically only useful when you're doing Cooperative Coevolution, where it's important to retain not only the performance of the Individual (his Fitness), but which collaborating Individuals made it possible for him to achieve that Fitness. Again, this is an optional variable though often useful. If `context` is

used, it's assumed that the slots of context hold each collaborator, except for the Individual himself, whose slot is set to null. Section 7.1.4.2 discusses the issue of context in more detail.

7.1.2 Grouped Problems

Since Coevolution involves evaluating multiple Individuals at once, it will require a new kind of Problem which takes multiple Individuals at a time. This Problem Form is defined by `ec.coevolve.GroupedProblemForm`. Evaluation in coevolution involves multiple trials, along these lines:

1. Performance scores of Individuals are cleared.
2. Individuals are tested against each other in various matches (or with one another in various collaborative problems). These trials cause trial performance scores of the Individuals to accumulate. If the trials are cooperative, the best trial found for a given Individual (its *context*) is maintained.
3. The final Fitnesses of the Individuals are set based on the performance scores over all the trials.

It's up to you to store the trial results and eventually form them into final Fitness values, as discussed later. It's also up to you to maintain the best context if you find this useful, as discussed later as well (in Section 7.1.4.2). `GroupedProblemForm` will help you by defining three methods to do these various portions of the evaluation process. You'll need to implement all three methods:

`ec.coevolve.GroupedProblemForm` Methods

```
public abstract void preprocessPopulation(EvolutionState state, int thread, boolean[] prepareForAssessment,  
                                         boolean countVictoriesOnly)
```

Called prior to the evaluation of a Population, mostly to clear the trials of Individuals. Only clear the trials for Individuals in Subpopulations for which *prepareForAssessment* is true. Note that although this method is not static, you should not assume that this method will be called on the same Problem as is used later for `evaluate(...)`. Thus don't use this method to set any instance variables in the Problem for later use. If *countVictoriesOnly* is true, the method being used is `SingleEliminationTournament`. Commonly you'll use this method to create a brand-new trials `ArrayList` for every Fitness of every Individual in every Subpopulation.

```
void evaluate(EvolutionState state, Individual[] individuals, boolean[] updateFitness, boolean countVictoriesOnly,  
             int[] subpops, int thread)
```

Evaluates the *individuals* in a single trial, setting their performance scores for that trial. Each individual will be from a certain subpopulation, specified in *subpops*. In some versions of coevolution, only certain individuals are supposed to have their performance scores updated (the others are acting as foils). In this case, the relevant individuals will be indicated in the *updateFitness* array. Typically you'll update fitness by adding trial results to the trials `ArrayList`. For any individual for whom you're updating trials, also set the Fitness value to reflect that one trial: this allows Single Elimination Tournament to compare Individuals based on this notional Fitness value. In doing so, do *not* set the evaluated flag for Individuals.

If you're doing cooperative coevolution, in this method you'll also probably want to maintain the context of the trial (the collaborating Individuals) if it's produced the best results so far. More on that in Section 7.1.4.2.

```
public abstract void postprocessPopulation(EvolutionState state, int thread, boolean[] assessFitness,  
                                         boolean countVictoriesOnly)
```

Called after evaluation of a Population to form final Fitness scores for the individuals based on the various performance scores they accumulated during trials; and then to set their evaluated flags to *true*. Only assess the Fitness and set the evaluated flags for Individuals in Subpopulations for which *assessFitness* is true. Note that although this method is not static, you should not assume that this method will be called on the same Problem as was used earlier for `evaluate(...)`. You'll probably want to set the trials variable to null to let it garbage collect.

Do not assume that Individuals will have the same number of trials: in several versions of Coevolution this will not be the case.

You're going to have to do some work to make sure that your Fitnesses are properly updated, and this depends on the kind of Coevolution you choose to do. So how do you keep track of trials? If you're just accumulating scores or wins, then you could use SimpleFitness and just increment it with each new win. But since different Individuals may have different numbers of trials, it's possible that you may need to keep track of the number of trials, or keep track of each trial result separately. Probably the best approach is to use the auxiliary variable trials found in ec.Fitness to store all your trials in an ArrayList. Thus you typically use GroupedProblemForm like this:

1. In preprocessPopulation(...), set the Fitness's trials to a new ArrayList for all Individuals.
2. In evaluate(...), add to trials the results of this trial for each Individual for whom updateFitness is set. Then set the Fitness to reflect just the immediate results of the trial (particularly if countVictoriesOnly is set). This allows Single Elimination Tournament—if you're using that—to determine who should advance to the next round. Make certain that whatever you add to trials is java.io.Serializable.
If you're doing cooperative coevolution, determine if the new trial is superior to all the existing trials previously found in the trials array. If it is, set the context of this trial using Fitness.setContext(...).
3. In postprocessPopulation(...), set the Fitness to the final result. For example, you might set it to the average or the maximum of the various trials. Finally, set the Fitness's trials to null to let it GC.

Notice that unlike in SimpleProblemForm (Section 3.4.1) there's no describe(...) method. This is because to describe an Individual, you'd need to do so in the context of other Individuals. So we left it out.

Example Assume we've replaced the Fitness with our MyCoevolutionaryFitness class. Let's create a Problem similar to the example in Section 4.1.1. In our Problem we take two Individuals, and the trial performance of an Individual is his vector values' product minus that of his opponent. Obviously this is a stupid example since Individuals are in a total ordering Fitness-wise: so it hardly illustrates the issues in Coevolution. But it'll suffice for the demonstration here. What we'll do is set an Individual's fitness to his average score over the trials performed.

```
package ec.app.myapp;
import ec.*;
import ec.simple.*;
import ec.vector.*;
import ec.coevolve.*;
public class MyCoevolutionaryProblem extends Problem implements GroupedProblemForm {

    public void preprocessPopulation(EvolutionState state, Population pop,
        boolean[] prepareForAssessment, boolean countVictoriesOnly) {
        for(int i = 0; i < pop.subpops.size(); i++)
            if (prepareForAssessment[i])
                for(int j = 0; j < pop.subpops.get(i).individuals.size(); j++) {
                    SimpleFitness fit = (SimpleFitness)(pop.subpops.get(i).individuals.get(j).fitness);
                    fit.trials = new ArrayList();
                }
    }

    public void evaluate(EvolutionState state, Individual[] ind, boolean[] updateFitness,
        boolean countVictoriesOnly, int[] subpops, int threadnum) {
        int[] genome1 = ((IntegerVectorIndividual)ind[0]).genome;
        int[] genome2 = ((IntegerVectorIndividual)ind[1]).genome;
        double product1 = 1.0;
        double product2 = 1.0;

        for(int x=0; x<genome1.length; x++) product1 = product1 * genome1[x];
```

```

for(int x=0; x<genome2.length; x++) product2 = product2 * genome2[x];

MyCoevolutionaryFitness fit1 = (MyCoevolutionaryFitness)(ind[0].fitness);
MyCoevolutionaryFitness fit2 = (MyCoevolutionaryFitness)(ind[1].fitness);

    if (updateFitness[0]) {
        fit1.trials.add(new Double(product1 - product2));
        // set the fitness in case we're using Single Elimination Tournament
        fit1.setFitness(state, fit1.fitness() + product1 - product2, false);
    }
    if (updateFitness[1]) {
        fit2.trials.add(new Double(product2 - product1));
        // set the fitness in case we're using Single Elimination Tournament
        fit2.setFitness(state, fit2.fitness() + product2 - product1, false);
    }
}

public void postprocessPopulation(EvolutionState state, Population pop,
                                boolean[] assessFitness, boolean countVictoriesOnly) {
    for(int i = 0; i < pop.subpops.size(); i++)
        if (assessFitness[i])
            for(int j = 0; j < pop.subpops.get(i).individuals.size(); j++) {
                SimpleFitness fit = (SimpleFitness)(pop.subpops.get(i).individuals.get(j).fitness);

                // Let's set the fitness to the average of the trials
                int len = fit.trials.size();
                double sum = 0;
                for(int l = 0; l < len; l++)
                    sum += ((Double)(fit.trials.get(l))).doubleValue();

                // Alternatively if we were interested in how *many* times we won rather
                // than by how much, we might set the fitness to, say, how often the doubleValue()
                // was positive.

                fit.setFitness(state, sum / len, false);
                pop.subpops.get(i).individuals.get(j).evaluated = true;
            }
    }
}

```

Now we hook it up as so:

```
eval.problem = ec.myapp.MyCoevolutionaryProblem
```

It's important to note that the trials variable doesn't have to store an ArrayList of *numbers* — it can store any object reflecting the outcome of a trial that you'd like to invent. It's available for you to use.

Generally the trials variable should never need to be cloned — it'll be set up, used during Evaluation, and then destroyed. The default implementation of the Fitness.cloneTrials() method, called by Fitness.clone(), simply throws an exception if trials is null.

7.1.3 One-Population Competitive Coevolution

In One-Population Competitive Coevolution, the whole population (or in ECJ parlance, a whole *Subpopulation*) competes in various games. The outcomes of those games determines the fitness of Individuals in the Subpopulation. Thus the Fitness of an Individual depends on which other Individuals it plays against.

ECJ does One-Population Competitive Coevolution with a special Evaluator called `ec.coevolve.CompetitiveEvaluator`, meant to be used in generational evolutionary methods. Building on the genetic algorithm example in Section 4.1.1, we'll replace the Evaluator:

```
eval = ec.coevolve.CompetitiveEvaluator
```

The main issue in One-Population Competitive Coevolution is the layout of the trials (competitions) between various Individuals. `CompetitiveEvaluator` provides the following options:¹

- Round Robin. Every Individual of the Subpopulation is paired up and evaluated with every other Individual, not including the Individual itself. The Fitness of both Individuals is updated. This is stipulated as:

```
eval.style = round-robin
```

- K-Random-Opponents (One-Way). Every Individual of the Subpopulation is paired up with K random opponents other than himself, picked at random with replacement. Only the Individual's fitness is updated, not his opponents'. This is stipulated, plus the size of K , as:

```
eval.style = rand-1-way  
eval.group-size = 8
```

Our experiments have tended to suggest that $K = 6$ to 8 are good values. Remember that larger group sizes result in many more evaluations.

- K-Random-Opponents (Two-Way). Every Individual of the Subpopulation is paired up with *at least* K random opponents other than himself, picked at random with replacement. Both Individuals' fitnesses are updated; thus being selected as an "opponent" allows an Individual to need fewer "regular" tests in order to fill his own K quota. Overall this results in about half the total number of tests as One-Way.

```
eval.style = rand-2-way  
eval.group-size = 8
```

A few individuals would be expected to be tested more than K times. If your fitness procedure simply cannot permit this, you can have the algorithm turn off fitness updating for those Individuals with:

```
eval.over-eval = false
```

- Single Elimination Tournament. All Individuals in the Subpopulation are paired up and evaluated. In each pair, the "winner" is the individual which winds up with the superior performance. If neither Individual is superior, then the "winner" is chosen at random. The winners advance to the next level: they're paired up and evaluated, and so on, just like in a single-elimination tournament. **Important note:** It is important that the Subpopulation size be a power of two for a proper Single-Elimination Tournament.

You stipulate Single-Elimination Tournament with:

```
eval.style = single-elim-tournament
```

After a single trial, you need to increment the Fitness of the winning Individual: this will tell Single-Elimination Tournament who to advance to the next round.² After all the trials have completed, we

¹Note that we used to have a number of other options at one point, many of which are still in the `CompetitiveEvaluator` source code of various ECJ versions, such as double-elimination tournament, world cup style, etc. But these have fallen by the wayside.

²Keep in mind that two Individuals compete with one another only because they've advanced to the same level, and so have the same Fitness initially.

will treat the Fitness of an Individual simply to be the number of trials it won, and so not modify the Fitness during `postprocessPopulation`. You can tell Single-Elimination Tournament is being used because `countVictoriesOnly` is true in the `GroupedProblemForm` methods.

One-Population Competitive Coevolution can be prohibitively expensive. So if you can use it, we suggest you *not* use Round Robin. Here's why. Round Robin is $O(n^2)$. K-Random-Opponents (One-Way) is $O(kn)$. K-Random-Opponents (Two-Way) is roughly $O(\frac{k}{2}n)$. But Single-Elimination Tournament is $O(n)$. When cast in terms of performance by number of evaluations, sometimes Single-Elimination Tournament performs best, though often K-Random-Opponents performs best with K set to somewhere between 6 and 8. We did a comparison paper on the two [17].

`ec.coevolve.CompetitiveEvaluator` is multithreaded and responds to the `evalthreads` parameter.

7.1.4 Multi-Population Coevolution

There are two common kinds of multi-population coevolution: 2-Population Competitive Coevolution and N -Population Cooperative Coevolution. Both are handled by the `ec.coevolve.MultiPopCoevolutionaryEvaluator` class:

```
eval = ec.coevolve.MultiPopCoevolutionaryEvaluator
```

In 2-Population Competitive Coevolution Individuals in each of two Subpopulations are tested by pitting them against Individuals in the opposing Subpopulation. The Fitness of an Individual is based on several such tests. Typically one Subpopulation is of interest; the other largely acts as a foil to challenge it.

In N -Population Cooperative Coevolution, a problem is broken into N subparts, and solutions for each subpart are optimized in separate Subpopulations. An Individual in a Subpopulation is tested by combining it with one member from each of the other Subpopulations to form a joint solution, which is then evaluated. Again, the Fitness of an Individual is based on several such tests.

When `ec.coevolve.MultiPopCoevolutionaryEvaluator` tests Individuals together, it typically selects one Individual from each Subpopulation and passes them to the `evaluate(...)` method: the order of the array of Individuals passed in should correspond to the order of the Subpopulations. Pay attention to the passed-in `updateFitness` array: only these individuals should be assessed based on a given test.

`ec.coevolve.MultiPopCoevolutionaryEvaluator` tests a given Individual in a Subpopulation in combination with Individuals selected from the other Subpopulations in various ways. The number of trials of each type that an Individual receives is determined by several associated parameters.

- Individuals selected at random, with replacement, from the current generation. The number of trials of this type is:

```
eval.num-current = 4
```

Since Individuals do not yet have their Fitnesses set, the selection procedure should be one which does not consider Fitness.³ You need to specify the selection procedure for each subpopulation. For example, if we had two Subpopulations, we could say:

```
eval.subpop.0.select-current = ec.select.RandomSelection
eval.subpop.1.select-current = ec.select.RandomSelection
```

`RandomSelection` is strongly recommended. Alternatively you could use the default parameter base:

```
eval.select-current = ec.select.RandomSelection
```

³What's the point then? Why bother with a `SelectionMethod` at all? Why not just pick Individuals at Random? The answer is simple: the `ec.spatial` package (Section 7.2) has a variation of Multi-Population Coevolution which uses its special version of `TournamentSelection`.

- Individuals selected at random, with replacement, from the previous generation. You provide the selection method for them; unlike before, this one can be based on Fitness if you like. For generation 0, Individuals are picked from the current generation and at random. For example, to specify the number of individuals of this type, and to use TournamentSelection, we might do:

```
eval.num-prev = 6
eval.subpop.0.select = ec.select.TournamentSelection
eval.subpop.0.select.size = 2
```

Again, you could use the default parameter base, though be warned that (in this example) it'll share parameters with all TournamentSelection uses.

```
eval.num-prev = 6
eval.select-prev = ec.select.TournamentSelection
select.tournament.size = 2
```

- The very fittest Individuals from the previous generation (or randomly chosen if we're at the generation 0). The number of fittest Individuals stored is the same as the number of trials (they're called "gurus"):⁴

```
eval.subpop.0.num-gurus = 5
```

- Individuals in the current Population are paired up using random shuffling. For each trial, all the Subpopulations are randomly shuffled⁵. Then each Individual #0 of each Subpopulation is paired together for a trial; likewise each Individual #1 of each Subpopulation, each Individual #2, and so on. This produces one trial for every Individual. For the next trial, all Subpopulations are randomly shuffled again, and so on.

Note that this procedure makes it possible to guarantee N trials per Individual with many fewer total trials: you can then use your saved Evaluations towards other things, such as more trials, larger Subpopulation sizes, or longer generations. To do 4 shuffled trials per Individual, you'd say:

```
eval.num-shuffled = 4
```

For competitive coevolution, you can use the same example as in Section 7.1.2 (GroupedProblemForm). For Cooperative Coevolution it's typical to base Fitness instead on the *maximum* of tests with N other collaborators. For example, let's revise the `postprocessPopulation(...)` method to assess trial performance as the sum of all the products of the genomes in the various Individuals:

⁴They used to be called "elites", but that was easily confused with elitism.

⁵Not actually shuffled — just shuffled internal index arrays to them: the effect is the same.

```

public void postprocessPopulation(EvolutionState state, Population pop,
                                boolean[] assessFitness, boolean countVictoriesOnly) {
    for(int i = 0; i < pop.subpops.size(); i++)
        if (assessFitness[i])
            for(int j = 0; j < pop.subpops.get(i).individuals.size(); j++)
                if (!pop.subpops.get(i).individuals.get(j).evaluated) {
                    SimpleFitness fit = (SimpleFitness)(pop.subpops.get(i).individuals.get(j).fitness);

                    // Let's set the fitness to the maximum of the trials
                    int len = fit.trials.size();
                    double max = Double.NEGATIVE_INFINITY;
                    for(int l = 0; l < len; l++)
                        max = Math.max(max, ((Double)(fit.trials.get(l))).doubleValue());

                    fit.setFitness(state, max, false);
                    pop.subpops.get(i).individuals.get(j).evaluated = true;
                }
    }
}

```

`ec.coevolve.MultiPopCoevolutionaryEvaluator` is not at present multithreaded. It does not respond to the `evalthreads` parameter.

Reminder It's laborious to write a zillion parameters if you have large numbers of subpopulations in your coevolution experiments. You can greatly simplify this process using the `pop.default-subpop` parameter (see Section 3.2.1).

7.1.4.1 Parallel and Sequential Coevolution

Note that the options above enable the "Parallel" and "Parallel Previous" coevolutionary techniques [10], but not the "Serial" (or "Sequential") technique whereby each Subpopulation is evaluated in turn. For Sequential coevolution, there's an additional parameter option in `ec.simple.SimpleBreeder`:

```
breed.sequential = true
```

Ordinarily `SimpleBreeder` breeds every Subpopulation every generation. But if this parameter is set, then `SimpleBreeder` will instead breed only one Subpopulation each generation. The chosen Subpopulation's index will be the generation number, modulo the number of Subpopulations.⁶

This parameter is very rarely used outside of sequential cooperative coevolution. `MultiPopCoevolutionaryEvaluator` responds to `SimpleBreeder`'s parameter as well to match the sequential breeding with sequential evaluation. That is, `MultiPopCoevolutionaryEvaluator` will only evaluate a single Subpopulation at a time (the same one that's later bred by `SimpleBreeder`).

Even though the evaluator and breeder are only updating one Subpopulation a generation, the `Statistics` classes are still doing statistics on *every* Subpopulation. However two basic `Statistics` subclasses (`ec.simple.SimpleStatistics` and `ec.gp.koza.KozaShortStatistics`, have some tweaks in them to print out the proper information. Specifically, when these `Statistics` classes print to screen the Fitnesses of the best individuals of each Subpopulation, they only do so if the individuals in question have their "evaluated" flags set. Otherwise it'll say "not evaluated". Recall that in `ec.coevolve.GroupedProblemForm` this only happens in `postprocessPopulation`, and only to individuals for whom the `assessFitness[]` slot is set. In sequential cooperative coevolution, that slot is set only for the subpopulation which is being updated that generation.

Okay fine, but what about the `Statistics`' logs? They'll still have nonsensical "best of generation" Individuals right? Yes, but you can tell which ones are valid simply by looking at their evaluated flags. Only the

⁶Note that though `SimpleBreeder` implements this, a number of subclasses of `SimpleBreeder` explicitly do *not*.

best individual of the currently-being-updated Subpopulation will have its evaluated flag set to true.

7.1.4.2 Maintaining Context

When you do Cooperative Coevolution, you'll probably want to retain information not only on how the Individual performed, but which collaborating Individuals helped him do his best. It's up to you to maintain this information, but ECJ's Fitness object provides a variable which can help:

```
public Individual[] context;
```

You can use this variable to store each collaborator, one per Subpopulation, plus one slot set to null to represent the Individual himself. The Fitness object will detect if this variable exists (by default it's null) and print out the context information when `printFitnessForHumans(...)` is called. Fitness will also handle cloning this array (it calls `newFitness.setContext(oldFitness.getContext(context))`) when the Fitness is cloned, etc. Fitness has some methods you can use rather than playing with the context directly:

ec.Fitness Methods

```
public void setContext(Individual[] cont, int index)
```

Sets the Fitness's context according to the information provided. The context is set to the clones of the individuals provided, except that `context[index]` is set to null. The `cont` array is not stored: rather, a new array is created for context.

```
public void setContext(Individual[] cont)
```

Sets the Fitness's context according to the information provided. The context is set to the clones of the individuals provided. The Fitness's individual must be set to null in the `cont` array. The `cont` array is not stored: rather, a new array is created for context. Alternatively, if `cont` is null, then the Fitness's context is eliminated and set to null.

```
public Individual[] getContext()
```

Returns the context, which may be null.

You'll want to update the context during the `evaluate(...)` method. Here's an example Cooperative Coevolution evaluation method:

```
public void evaluate(EvolutionState state, Individual[] ind, boolean[] updateFitness,
                   boolean countVictoriesOnly, int[] subpops, int threadnum)
{
    // First compute the value of this trial. For example, imagine if each Individual was a
    // DoubleVectorIndividual, and the fitness function was simply their sum.
    double sum = 0;
    for(int i = 0; i < ind.length; i++)
    {
        DoubleVectorIndividual dind = (DoubleVectorIndividual)(ind[i]);
        for(int j = 0; j < dind.genome.length; j++)
            sum += dind.genome[j];
    }

    // next update each Individual to reflect this trial result
    for(int i = 0; i < ind.length; i++)
    {
        if (updateFitness[i]) // need to include this trial for this Individual
        {
            // We presume that the best trial found so far has been stored at
            // position 0 of the trials array. This makes it O(1) to determine if
            // we're the new "best trial". Heeere we go!

```

```

    ArrayList tr = ind[i].fitness.trials;
    if (tr.size() == 0) // we're the first trial to be performed so far
    {
        tr.add(new Double(sum)); // just dump us in
        ind[i].fitness.setContext(ind, i); // set the context to us
    }
    else if (((Double)(tr.get(0))).doubleValue < sum) // we're the new best
    {
        // swap us to the 0th position
        Double t = (Double)(tr.get(0));
        tr.set(0, new Double(sum)); // I'm at 0
        tr.add(t); // move the old guy to the end of the line
        ind[i].fitness.setContext(ind, i); // set the context to us
    }

    // don't bother setting the fitness here
}
}
}

```

Warning Maintaining context in this way is expensive. If you have N individuals involved in a trial, you'll likely be updating the context on all N of them, and each context array is N size, so you're looking at an $O(N^2)$ operation for every trial! If you're doing coevolution with 1000 subpopulations, that's a million array slots for *each* trial of *each* individual. Furthermore, if you are using `ec.simple.SimpleStatistics`, large contexts will be printed to disk.

In this situation, you probably want to simply avoid setting context: it's just too expensive.

7.1.5 Performing Distributed Evaluation with Coevolution

Coevolution introduces its own wrinkle to Distributed Evaluation, because it has multiple trials, and each of those trials is a separate job potentially processed on a separate machine. We need a way to merge all those trials together to compute the final fitness. Furthermore we may need a way to determine which context (see Section 7.1.4.2) among those merged trials should be retained. If your trial results are `java.lang.Double`, with higher values considered better, you probably don't need to do anything. Otherwise you'll need to make a tweak. Here's some details on how the mechanism works.

When ECJ sends off a group of Individuals to a remote site to be evaluated using a `ec.coevolve.GroupedProblemForm`, the first thing it does (in `ec.eval.Job`) is make clones of them, then strip the clones of both trials and context. When the Individuals come back, they need to have their trials and context reintegrated with the original Individuals. This is done by calling the `merge(...)` method on the Individuals.

The `Individual.merge(...)` method isn't particularly efficient but it gets the job done. First, it calls `Fitness.merge(...)` to handle merging trials and context (actual fitness value isn't bothered with — at this point it doesn't matter). However this merging isn't in the direction you think: the *old* Fitness is merged into the new Fitness. Then it copies the entire new Individual, including the merged Fitness, into the old Individual, displacing it. This way the merged Fitness retains the new fitness value, plus merged trials and context.

How are trials and context merged? Keep in mind that when the Individual was cloned and sent to the remote site to be evaluated, the clone's trials and context were stripped. When the cloned Individual returns and must be merged with the original Individual, the cloned Individual will have a new context and one or more new trials. `Fitness.merge(...)` retains the trials group with the best trial result: accordingly, this is the context that is retained. Then the new trials are appended to the original trials.

The crucial item. To determine which group of trials contains a superior trial, `Fitness.merge(...)` calls a method called `Fitness.contextIsBetterThan(Fitness other)`. This method returns true if the given Fitness's trials are superior to the "other" Fitness's trials. **This method assumes that trials are `java.lang.Double`.**

If they are not, you'll need to override this method and replace it. Recall again that **even if your trials are not java.lang.Double, they must be immutable: their internals cannot be modified, so they can be pointer-copied and not just cloned.**

Here are the relevant methods of interest:

ec.Individual Methods

```
public void merge(EvolutionState state, Individual other)
```

Merges the other Individual into the original Individual, including Fitnesses. After the merge, (1) the Individual should be a copy of other (2) the Fitness's value should be a copy of other (3) the Fitness's trials should be a merger of the original trials and those of other (4) the higher-quality context of the two Individuals should be retained. By default this method does this by calling `other.fitness.merge(fitness)` (note the backwards merge), then copying back the entirety of other into the original Individual.⁷ You'll rarely need to override this method.

ec.Fitness Methods

```
public void merge(EvolutionState state, Fitness other)
```

Merges the other Fitness into the original Fitness. The only thing that needs to be merged is trials and context. If other has better trials than the original Individual, its context replaces the original context. Then the trials are concatenated together. Calls `contextIsBetterThan(...)` to determine which Fitness has the superior trials, and thus context. You'll not often need to override this method, but may need to override `contextIsBetterThan(...)`.

```
public boolean contextIsBetterThan(Fitness other)
```

Returns true if my context is better than the other Fitness's context. This is computed by comparing our trials: if I have trials and the other does not, or if one of my trials is superior to all of the other's trials, then this method returns true. This method assumes that trials are `java.lang.Double`, and that higher values are better. If this is not the case, you'll need to override this method to customize it.

7.2 Spatially Embedded Evolutionary Algorithms (The `ec.spatial` Package)

The `ec.spatial` package helps in designing evolutionary algorithms in which the Individuals in a Subpopulation are embedded in a metric space of some kind, and their decisions about breeding and/or selection are based on their location in that space and their relationship with other Individuals. For example, an Individual chosen to breed might be restricted to only do so with Individuals near to himself.

In order for a Subpopulation to be used in a spatially-embedded way, it must implement the `ec.spatial.Space` interface. This interface enables the Breeder to set an *index* for a **target** Individual in the Space, then later request a neighbor, chosen at random, within a given *distance* in the Space of that target Individual.

ec.spatial.Space Methods

```
public void setIndex(int thread, int index)
```

Set the index for a certain target Individual in the Space. (Each thread can have its own index).

```
public int getIndex(int thread)
```

Return the index for the current target Individual in the Space. (Each thread can have its own index).

⁷How is this magic copying done? By use of a `ec.util.DataPipe`: we first call `other.writeIndividual(...)` into the pipe, then call `readIndividual(...)` from the pipe. It's a hack but it works, and avoids the need for a custom version of `Individual.merge` for every possible genotype.

```
public int getIndexRandomNeighbor(EvolutionState state, int thread, int distance)
    Return the index of a neighbor in the embedded space, chosen at random, and who is no more than distance away
    from the current target individual.
```

This seems convoluted. Why store indices? Why you might ask, can't we just pass in the index into the `getIndexRandomNeighbor` method? The answer is: because at the time this method is called (usually during a `TournamentSelection` method call), the index isn't available. Another option would be to store the index not in the `Space` but in a `Breeder`,⁸ but it turns out that `Spaces` can be used not only for breeding but also for Evaluation. So we're storing the indices in the only logical location left: the `Space` itself.

7.2.1 Implementing a Space

ECJ has one common space implemented for you already: a toroidal 1D ring. For fun, let's implement another space: a 2D *non*-toroidal 10x10 space.⁹ We'll start with the easy part: storing the per-thread index array.

```
public class 2DSubpopulation extends Subpopulation implements Space {
    int[] indices;

    public void setup(EvolutionState state, Parameter base) {
        super.setup(state, base);
        indices = new int[state.breedthreads];
    }

    public Group emptyClone() {
        2DSubpopulation other = (2DSubpopulation) (super.emptyClone());
        other.indices = new int[indices.length];
        return other;
    }

    public void setIndex(int thread, int index) { indices[thread] = index; }

    public int getIndex(int thread) { return indices[thread]; }
```

Now we need to implement the `getIndexRandomNeighbor` method. We'll define a random neighbor as one which is within the rectangular box up to *distance* away from the target index.

```
public int getIndexRandomNeighbor(EvolutionState state, int thread, int distance) {
    if (individuals.size() != 100)
        state.output.fatal("This ridiculous example requires that the Subpopulation" +
            "be exactly 100 in size.")

    int target = getIndex(thread);
    int targetX = target / 10; // integer division
    int minX = targetX - distance < 0 ? 0 : targetX - distance;
    int maxX = targetX + distance > 9 ? 9 : targetX + distance;

    int targetY = target % 10;
    int minY = targetY - distance < 0 ? 0 : targetY - distance;
    int maxY = targetY + distance > 9 ? 9 : targetY + distance;
```

⁸This is what's done in `MuCommaLambdaBreeder` (Section 4.1.2) to enable the magic of `ESSelection` always picking a certain individual.

⁹I didn't say it'd be useful: just an easy demonstration!

```

    int x = minX + state.random(thread).nextInt(maxX - minX + 1);
    int y = minY + state.random(thread).nextInt(maxY - minY + 1);

    return x * 10 + y;
}
}

```

7.2.2 Spatial Breeding

To breed, you can use the Space ECJ has already done for you: a 1D Space. `ec.spatial.Spatial1DSubpopulation` can be set up to be either toroidal (the default) or non-toroidal. To use it as toroidal, you might say:

```

pop.subpop.0 = ec.spatial.Spatial1DSubpopulation
pop.subpop.0.toroidal = true

```

You'll also need a selection procedure which understands how to pick using Spaces. ECJ provides one such procedure: `ec.spatial.SpatialTournamentSelection`. This selection operator picks its tournament members randomly from the Subpopulation but constrained so that they're within *distance* of the target index. That is: it uses `getIndexRandomNeighbor(...)` to pick them.

`SpatialTournamentSelection` has three parameter options above and beyond the standard `TournamentSelection` operators. Let's say that `SpatialTournamentSelection` is our pipeline's first source:

```

pop.subpop.0.species.pipe.source.0 = ec.spatial.SpatialTournamentSelection
pop.subpop.0.species.pipe.source.0.size = 2
pop.subpop.0.species.pipe.source.0.pick-worst = false
pop.subpop.0.species.pipe.source.0.neighborhood-size = 3
pop.subpop.0.species.pipe.source.0.ind-competes = false
pop.subpop.0.species.pipe.source.0.type = uniform

```

The size parameter should be obvious: it's `TournamentSelection`'s tournament size. Likewise the `pick-worst` parameter determines whether we're picking the fittest or the least fit of the tournament. The remaining three parameters are as follows. `neighborhood-size` defines the distance from the target index. If `ind-competes` is true, then at least one member of the tournament is guaranteed to be the target Individual itself. Last, if `type` is `uniform`, then an individual is picked simply using `getIndexRandomNeighbor(...)`. However you also have the option of doing a **random walk** through the space. The walk will be `neighborhood-size` steps and each step will move to a neighbor immediately bordering your current position (that is, one chosen when you pass in 1 as the distance to `getIndexRandomNeighbor`). Random walks of this kind approximate a Gaussian distribution centered on the target Individual. You can choose to do a random walk rather than uniform selection with:

```

pop.subpop.0.species.pipe.source.0.type = random-walk

```

You can of course use the default parameters for this kind of stuff. Note that since the default parameter base is different, you need to specify all the standard `Tournament Selection` stuff under this default base, not under `Tournament Selection`'s own default base (`select.tournament`):

```

spatial.tournament.size = 2
spatial.tournament.pick-worst = flase
spatial.tournament.neighborhood-size = 3
spatial.tournament.ind-competes = false
spatial.tournament.type = uniform

```

In order for `SpatialTournamentSelection` to work, you'll have to have the target Individual set. This is the job of `ec.spatial.SpatialBreeder`, a simple extension of `SimpleBreeder`. The procedure works like this. For each Individual *i* in the new Subpopulation to fill:

1. SpatialBreeder sets the target index to i .
2. SpatialBreeder requests one Individual from its Pipeline
3. SpatialTournamentSelection methods in that Pipeline use this index to compute distances and pick Individuals

Warning: Note that although SpatialBreeder is enumerating over the *new Subpopulation*, the SpatialTournamentSelection operator is using the target index to pick Individuals from the *old Subpopulation*. This means that Subpopulations must not change in size from generation to generation.

SpatialBreeder is very simple: there are no parameters to set up at all.

7.2.3 Coevolutionary Spatial Evaluation

The spatial package also enables one of many¹⁰ possible approaches to doing coevolution in a spatially embedded Subpopulation. Recall from Section 7.1.4 that the `ec.coevolve.MultiPopCoevolutionEvaluator` class performs multi-population coevolution: each Individual is tested N times, each time by grouping it with one Individual from each of the other Subpopulations. These other Individuals are called **collaborators**. The `ec.spatial.SpatialMultiPopCoevolutionaryEvaluator` extends this by allowing you to pick those collaborators in a spatial manner: their locations in their respective Subpopulations are near to the position of the target Individual in his Subpopulation:

```
eval = ec.spatial.SpatialMultiPopCoevolutionaryEvaluator
```

The way this is done is by using the `SpatialTournamentSelection` class to pick collaborators, based on the target Individual's index. Two kinds of collaborators can be picked with a Selection Method in `MultiPopCoevolutionEvaluator`: members of the current Population, and members of the previous generation's Population. You need to be careful with the first situation, since the members don't have their Fitnesses set, and so you can't use a Selection Method which is based on Fitness. In the examples in Section 7.1.4, we used `RandomSelection`. But for spatial coevolution, we can do a "random" selection which simply picks a collaborator based on the neighborhood from the target Individual. We do this by setting the `size` parameter in `SpatialTournamentSelection` — the tournament size — to 1:

```
eval.subpop.0.select-current = ec.spatial.SpatialTournamentSelection

# It's important that the size be 1 ---
# this causes 'random' selection, so Fitness is not considered
eval.subpop.0.select-current.size = 1
eval.subpop.0.select-current.pick-worst = false
eval.subpop.0.select-current.neighborhood-size = 3

# It's also important that this value be false ---
# otherwise the target index will always be selected
eval.subpop.0.select-current.ind-competes = false
eval.subpop.0.select-current.type = uniform

eval.subpop.1.select-current = ec.spatial.SpatialTournamentSelection
eval.subpop.1.select-current.size = 1
eval.subpop.1.select-current.pick-worst = false
eval.subpop.1.select-current.neighborhood-size = 3
eval.subpop.1.select-current.ind-competes = false
eval.subpop.1.select-current.type = random-walk
```

¹⁰The other obvious approach would be a variant of `ec.coevolve.CompetitiveEvaluator` where competitors to test Individuals in a population are selected based on nearness to the Individual. Perhaps we might put this together one day.

You can also select collaborators from the previous generation based on spatial distance. In this case, you can have the Selection Method pick based on Fitness too (though you don't have to if you don't want to). For example:

```
eval.subpop.0.select-prev = ec.spatial.SpatialTournamentSelection
eval.subpop.0.select-prev.size = 2
eval.subpop.0.select-prev.pick-worst = false
eval.subpop.0.select-prev.neighborhood-size = 3
eval.subpop.0.select-prev.ind-competes = false
eval.subpop.0.select-prev.type = uniform

eval.subpop.1.select-prev = ec.spatial.SpatialTournamentSelection
eval.subpop.1.select-prev.size = 7
eval.subpop.1.select-prev.pick-worst = false
eval.subpop.1.select-prev.neighborhood-size = 4
eval.subpop.1.select-prev.ind-competes = true
eval.subpop.1.select-prev.type = random-walk
```

The remaining parameters are basically just like those in MultiPopCoevolutionaryEvaluator (see Section 7.1.4), for example:

```
eval.num-current = 4
eval.num-prev = 6
eval.subpop.0.num-gurus = 5
```

Warning: Just like was the case for Spatial Breeding, Spatial Multi-Population Coevolution requires that Subpopulations not change in size from generation to generation.

7.3 Particle Swarm Optimization (The `ec.pso` Package)

The `ec.pso` package provides a basic framework for Particle Swarm Optimization (PSO).

PSO differs from most other population-based optimization methods in that the individuals never die, never are selected, and never breed. Instead they just undergo a directed mutation influenced by personal best results, neighborhood (“informant”) best results, and global best results.

ECJ’s PSO algorithm works like this. Each individual is an instance of the class `ec.pso.Particle`, which is itself a subclass of `ec.vector.DoubleVectorIndividual`. Because it’s a `DoubleVectorIndividual`, you should use the associated species `ec.vector.FloatVectorspecies`.

Particles hold various information:

- The particle’s (real-valued) *genome* (or, in PSO parlance, its “location”).
- The particle’s *velocity*. This is equal to the Particle’s present genome, minus the genome it had last generation.
- The best genome the particle has ever had (its *personal best*)
- The fitness the particle had when it held its personal best genome.
- The best genome ever discovered from among the *neighbors* or *informants* of the particle.
- The fitness assigned to the best-of-neighbors genome
- The indexes into the subpopulation array of the members of the subpopulation comprising the neighbors (or informants) of the particle.

The genome is stored in the `DoubleVectorIndividual` superclass. Other items are stored like this:

```

// my velocity
public double[] velocity ;

// the individuals in my neighborhood
public int[] neighborhood = null ;

// the best genome and fitness members of my neighborhood ever achieved
public double[] neighborhoodBestGenome = null;
public Fitness neighborhoodBestFitness = null;

// the best genome and fitness *I* personally ever achieved
public double[] personalBestGenome = null;
public Fitness personalBestFitness = null;

```

Notice that some values are initially null, and will be set when the particle discovers proper values for them. The velocity is at present initially all zero.

PSO has a special breeder called `ec.pso.PSOBreeder`. This breeder holds the *global best genome* ever discovered by the subpopulation, and its associated fitness:

```

public double[][] globalBest = null ; // one for each subpopulation
public Fitness[] globalBestFitness = null;

```

Note that `PSOBreeder` is **single-threaded** for now, though that may change in the future.

Reading and Writing Particles have a lot of data, and this impacts on their ability to read and write to files, streams, etc. Some notes:

- If you are writing a Particle for human consumption (using `printIndividualForHumans()`), it will write out just like a `DoubleVectorIndividual`: velocity information, neighborhood information, personal information, etc.
- If you are writing a Particle meant to be read by a computer (using `printIndividual()` or `writeIndividual()`), it will write out the `DoubleVectorIndividual` information, followed by all the auxiliary information *except* for global best information, which is stored in `PSOBreeder` and not Particle.

Updating Each timestep, all particles simultaneously compute three vectors: the difference between the particle's personal best and the particle's genome (that is, a vector *towards* the personal best), the difference between the particle's neighborhood best and the particle's genome, and finally the difference between the global best and the particle's genome. These vectors essentially act to move the particle towards the personal best, neighborhood best, and global best.

Then the particle updates its velocity as the weighted sum of its old velocity and these three vectors. The four weights are global values and are defined in `PSOBreeder` as:

```

public double velCoeff;           // coefficient for the velocity
public double personalCoeff;      // coefficient for self
public double informantCoeff;     // coefficient for informants/neighbors
public double globalCoeff;        // coefficient for global best

```

Finally, each particle updates its location (genome) as the sum of the old genome and the new velocity, effectively moving the particle "towards" these respective values.

These coefficients are specified fairly straightforwardly.

```
breed.velocity-coefficient = 0.7
breed.personal-coefficient = 0.4
breed.informant-coefficient = 0.4
breed.global-coefficient = 0.0
```

Notice that the global-coefficient is set to 0 in the example above: we've found it's not very good and best left out. And we're not alone — a lot of current PSO practice does this as well.

PSO determines the *neighbors* or *informants* of a particle in one of three ways. Both require that you specify a *neighborhood size* (the number of informants to the individual), for example:

```
# We strongly suggest this be an even number if you're doing toroidal (see below)
breed.neighborhood-size = 10
```

Then you can either have ECJ:

- Select informants at *random without replacement* for each particle at the beginning of the run (not including the particle itself).
- Select informants at *random without replacement* for each particle, not including the particle itself. This is done every single generation.
- Select the $\lfloor N/2 \rfloor$ informants immediately below the of the particle's position in the population, and the $\lceil N/2 \rceil$ informants immediately above the particle's position. This is toroidal (wrap-around), is done at the beginning of the run, and does not include the particle itself.

These three options are *random*, *random-each-time*, and *toroidal* respectively:

```
breed.neighborhood-style = random
#breed.neighborhood-style = random-each-time
#breed.neighborhood-style = toroidal
```

(Note that the 2007 PSO C standard suggests that it's using *random-each-time*, but we've informally found *random* or *toroidal* to perform better.) To this collection of informants, you can also add the particle itself with:

```
breed.include-self = true
```

The default is false in ECJ, but in historical forms of PSO this was set to true.

Finally, you'll also need to specify the breeder and individual:

```
breed = ec.pso.PSOBreeder
pop.subpop.0.species = ec.vector.FloatVectorSpecies
pop.subpop.0.species.ind = ec.pso.Particle
```

The rest of the parameters are fairly standard, though since we're using *FloatVectorSpecies*, we'll need to specify a pipeline and various mutation and crossover methods even though we don't use them. We can pick dummy stuff for this. Here's an example of a full working PSO parameter file:

```

state = ec.simple.SimpleEvolutionState
init = ec.simple.SimpleInitializer
finish = ec.simple.SimpleFinisher
exch = ec.simple.SimpleExchanger
breed = ec.pso.PSOBreeder
eval = ec.simple.SimpleEvaluator
stat = ec.simple.SimpleStatistics
stat.file $out.stat

breedthreads = auto
evalthreads = auto
checkpoint = false
checkpoint-modulo = 1
checkpoint-prefix = ec
generations = 1000
quit-on-run-complete = true
pop = ec.Population
pop.subpops = 1
pop.subpop.0 = ec.Subpopulation
pop.subpop.0.size = 1000
pop.subpop.0.duplicate-retries = 2
pop.subpop.0.species = ec.vector.FloatVectorSpecies
pop.subpop.0.species.ind = ec.pso.Particle
pop.subpop.0.species.fitness = ec.simple.SimpleFitness

# You have to specify some kind of dummy pipeline even though we won't use it
pop.subpop.0.species.pipe = ec.vector.breed.VectorMutationPipeline
pop.subpop.0.species.pipe.source.0 = ec.select.TournamentSelection
select.tournament.size = 2

# You also have to specify a few dummy mutation parameters we won't use either
pop.subpop.0.species.mutation-prob = 0.01
pop.subpop.0.species.mutation-stdev = 0.05
pop.subpop.0.species.mutation-type = gauss
pop.subpop.0.species.crossover-type = one

# Here you specify your individual in the usual way
pop.subpop.0.species.genome-size = 100
pop.subpop.0.species.min-gene = -5.12
pop.subpop.0.species.max-gene = 5.12

# Problem. Here we're using ECSuite's rastrigin function
eval.problem = ec.app.ecsuite.ECSuite
eval.problem.type = rastrigin

# PSO parameters

breed.velocity-coefficient = 0.7
breed.personal-coefficient = 0.4
breed.informant-coefficient = 0.4
breed.global-coefficient = 0.0
breed.neighborhood-size = 10
breed.neighborhood-style = random
breed.include-self = false

```

7.4 Differential Evolution (The ec.de Package)

The ec.de package provides a Differential Evolution framework and some basic DE breeding operators. Differential Evolution is notable for its wide range of operator options: ECJ only has a few of them defined, but others are not hard to create yourself.

Differential Evolution does not have a traditional selection mechanism: instead, children are created entirely at random but then must compete with their parents for survival. Additionally, Differential Evolution breeding operators are somewhat opaque and not particularly amenable to mixing and matching. Because of this, we have eschewed the Breeding Pipeline approach for doing breeding. Instead, Differential Evolution simply has different Breeders for each of its breeding operator approaches. Differential Evolution operators are defined by creating a subclass of ec.de.DEBreeder. We have three such operators implemented, including the default in ec.de.DEBreeder itself: more on them in a moment.

7.4.1 Evaluation

We implement DE's unusual selection procedure through a custom SimpleEvaluator called ec.de.DEEvaluator. It turns out this code could have been done in ec.de.DEBreeder (making the package simpler) but then various Statistics objects wouldn't report the right values. So we made a simple Evaluator to do the job. DEEvaluator is very simple subclass of SimpleEvaluator and works just like it, including multithreaded evaluation. You specify it as follows:

```
eval = ec.de.DEEvaluator
```

7.4.2 Breeding

Before we start, note that Differential Evolution does not use ECJ's breeding pipelines. However, ECJ species still expect some kind of pipeline even though it won't be used. So you might define a default pipeline for a species like this:

```
# This pipeline won't be used, it's just a dummy, pick some simple
stuff pop.subpop.0.species.pipe = ec.breed.ReproductionPipeline
pop.subpop.0.species.pipe.source.0 = ec.select.FirstSelection
```

If you're using DoubleVectorIndividual (and you probably are), you'll need some default mutation and crossover stuff too, though it again won't be used. Some of this stuff are required (but unused parameters), others are here just to quiet warnngs:

```
pop.subpop.0.species.mutation-prob = 1.0 pop.subpop.0.species.mutation-type = reset
pop.subpop.0.species.crossover-type = one
```

Okay back to breeding. DEBreeder serves both as the superclass of all DE breeding operators, and also implements the basic "classic" Differential Evolution breeding operator, known as DE/rand/1/bin. We begin by talking about the top-level elements of DEBreeder, then we discuss DEBreeder's specific default operator, followed by other operators.

Most Differential Evolution breeding operators work as follows. For each Individual \vec{d} in the Population (recall that in Differential Evolution all Individuals are DoubleVectorIndividuals, so we'll treat them as vectors), we will create a single child \vec{c} . After this is done, we replace each parent with its child if the child is as good or better than the parent (this last part is done in DEEvaluator).

Children are usually, but not always created by first generating a child \vec{d} through a combination, of sorts, of Individuals than \vec{d} . We then perform a crossover between d and a , essentially replacing parts of d with a , which results in the final child c . Thus there are often two parts to creating children: first building d , then crossing over d with a .

The whole creation process is handled by a single method:

ec.de.DEBreeder Methods

```
public DoubleVectorIndividual createIndividual(EvolutionState state, int subpop, int index, int thread)
    Creates and returns a new Individual derived from the parent Individual found in
    state.population.subpops.get(subpop).individuals.get(index), using other individuals chosen from
    state.population.subpops.get(subpop) as necessary.
```

The default implementation performs the DE/rand/1/bin operation, discussed later. If you want to create a whole new breeding operator, you'll largely need to override this individual-creation method.

Because crossover is a common operation, ECJ has broken it out into a separate method. You can override just this method, if you like, to customize how crossover is done.

ec.de.DEBreeder Methods

```
public DoubleVectorIndividual crossover(EvolutionState state, DoubleVectorIndividual target,
                                       DoubleVectorIndividual child, int thread)
    Crosses over child (earlier referred to as  $\vec{d}$ ) with target (earlier referred to as  $\vec{a}$ ), modifying child. child is then
    returned.
```

The default implementation performs uniform crossover: for each gene, with independent probability C_r , the child's gene will be replaced with the target's gene. One child gene, chosen at random, is guaranteed to *not* be replaced.

The C_r value, which must be between 0.0 and 1.0, is set by a parameter:

```
breed.cr = 0.5
```

And it's stored in the following DEBreeder instance variable:

```
public double Cr;
```

You can leave this parameter unspecified: as mentioned before, some DEBreeder subclasses do no crossover and so don't need it. But if crossover *is* performed and the parameter is unspecified (it's set to the value `ec.DEBreeder.CR_UNSPECIFIED`), it'll be assumed to be 0.5 (probably not a good choice) and a warning will be issued.

The combination of various Individuals to form \vec{d} in the first place is usually a mathematical vector operation involving certain variables. The most common variable, used by all the operators in this package, is a scaling factor F , which ranges from 0.0 to 1.0. We define F like this:

```
breed.f = 0.6
```

The F parameter is then stored in the following DEBreeder instance variable:

```
public double F;
```

Unlike C_r , F is required as a parameter.

Some DE breeding operators need to know the fittest Individual in the Subpopulation. Thus prior to constructing individuals, DEBreeder first computes this whether it's used or not. The location of the fittest Individuals, indexed by Subpopulation, are stored in the following DEBreeder variable:

```
public int[] bestSoFarIndex;
```

For example, you can get the fittest Individual in Subpopulation 0 as:

```

DoubleVectorIndividual bestForSubpopZero = (DoubleVectorIndividual)
    (state.population.subpops.get(0).individuals.get(bestSoFarIndex[0]));

```

Last but not least, DEBreeder must store away the old Population before it is overwritten by the new child Individuals. This is because in DEEvaluator the original parents in the old Population get a chance to displace the children if the children are not sufficiently fit. So we need to keep the parents around until then. The parents are stored in DEBreeder as:

```

public Population previousPopulation;

```

This value is initially null, since there are no parents in the first generation. But in successive generations it's set to the parents.

A final note: though evaluation is multithreaded, breeding at present is not. The breedthreads parameter has no effect.

7.4.2.1 The DE/rand/1/bin Operator

The “classic” DE breeding operator, DE/rand/1/bin, is the default operator implemented by DEBreeder itself. The implementation follows that found on page 140 of the text *Differential Evolution* [20]. It works as follows. For each Individual \vec{a} in the Subpopulation, we select three other Individuals at random. These Individuals must be different from one another and from \vec{a} . We'll call them \vec{r}_0 , \vec{r}_1 , and \vec{r}_2 . We create a child \vec{d} whose values are defined as:

$$d_i = r_{0i} + F \times (r_{1i} - r_{2i})$$

We then cross over d with a , producing a final child c , which is then placed in the new Subpopulation. Note the use of the F parameter.

To use this operator, you'll need to specify DEBreeder as the breeder, and of course also set the F and Cr parameters as well. For example:

```

breed = ec.de.DEBreeder
breed.f = 0.6
breed.cr = 0.5

```

This operator can produce values which are outside the min/max gene range. You'll need to specify whether or not you wish to force the operator to only produce values bounded to within that range. For example, to turn off bounding and allow values to be anything, you would say (on a per-Species basis):

```

pop.subpop.0.species.mutation-bounded = false

```

Otherwise you'd say:

```

pop.subpop.0.species.mutation-bounded = true

```

If you bound the operator, then it will try repeatedly with new values of \vec{r}_0 , \vec{r}_1 , and \vec{r}_2 , until it produces a valid individual d_i .

7.4.2.2 The DE/best/1/bin Operator

The class `ec.de.Best1BinDEBreeder`, a subclass of `DEBreeder`, implements the DE/best/1/bin operator, plus “random jitter”, as found on page 140 of the text *Differential Evolution* [20]. It works as follows. For each Individual \vec{a} in the Subpopulation, we first identify the *fittest* Individual \vec{b} in the Subpopulation, and also select two other Individuals at random. These Individuals must be different from one another, from \vec{b} , and from \vec{a} . We'll call them \vec{r}_1 and \vec{r}_2 . We create a child \vec{d} whose values are defined as:

$$d_i = \vec{b} + \text{jitter}() \times (r1_i - r2_i)$$

We then cross over d with a , producing a final child c , which is then placed in the new Population. $\text{jitter}()$ produces different random numbers for each i . It's defined as:

$$\text{jitter}() = F + FNOISE \times (\text{random}(0,1) - 0.5)$$

The $\text{random}(0,1)$ function returns a random number between 0.0 and 1.0 inclusive. Again, note the use of the F parameter. The $FNOISE$ constant is typically 0.001. It's defined by the parameter `breed.f-noise` and is stored in the `Best1BinDEBreeder` instance variable:

```
public double F_NOISE;
```

To use this breeding operator, you'll need to specify the breeder and the various parameters:

```
breed = ec.de.Best1BinDEBreeder
breed.f = 0.6
breed.cr = 0.5
breed.f-noise = 0.001
```

This operator can produce values which are outside the min/max gene range. You'll need to specify whether or not you wish to force the operator to only produce values bounded to within that range. For example, to turn off bounding and allow values to be anything, you would say (on a per-Species basis):

```
pop.subpop.0.species.mutation-bounded = false
```

Otherwise you'd say:

```
pop.subpop.0.species.mutation-bounded = true
```

If you bound the operator, then it will try repeatedly with new values of $r\vec{1}$ and $r\vec{2}$, until it produces a valid individual d_i .

7.4.2.3 The DE/rand/1/either-or Operator

The class `ec.de.Rand1EitherOrDEBreeder`, again a subclass of `DEBreeder`, implements the DE/rand/1/either-or operator, as found on page 141 of the text *Differential Evolution* [20]. It works as follows. For each Individual \vec{a} in the Subpopulation, we select three other Individuals at random. These Individuals must be different from one another and from \vec{a} . We'll call them $r\vec{0}$, $r\vec{1}$, and $r\vec{2}$. Then with probability PF , we create a child \vec{d} defined in the same way as the DE/rand/1/bin operator:

$$d_i = r0_i + F \times (r1_i - r2_i)$$

... else we create the child like this:

$$d_i = r0_i + 0.5 \times (F + 1) \times (r1_i + r2_i - 2 \times r0_i)$$

We do *not* cross over d with a : we simply return d as the child.

The PF probability value, which must be between 0.0 and 1.0, is defined by the parameter `breed.pf` and is stored in the `Rand1EitherOrDEBreeder` instance variable:

```
public double PF;
```

To use this breeding operator, you'll need to specify the breeder and the various parameters:

```
breed = ec.de.Rand1EitherOrDEBreeder
breed.f = 0.6
breed.pf = 0.5
```

Note that the C_r parameter is not used, since no crossover is performed.

This operator can produce values which are outside the min/max gene range. You'll need to specify whether or not you wish to force the operator to only produce values bounded to within that range. For example, to turn off bounding and allow values to be anything, you would say (on a per-Species basis):

```
pop.subpop.0.species.mutation-bounded = false
```

Otherwise you'd say:

```
pop.subpop.0.species.mutation-bounded = true
```

If you bound the operator, then it will try repeatedly with new values of \vec{r}_0 , \vec{r}_1 , and \vec{r}_2 , until it produces a valid individual d_i .

7.5 Multiobjective Optimization (The `ec.multiobjective` Package)

ECJ has three packages which handle multiobjective optimization: the `ec.multiobjective` package, and two concrete implementations (SPEA2 and NSGA-II): the `ec.multiobjective.spea2` and `ec.multiobjective.nsga2` packages respectively.

7.5.0.1 The `MultiObjectiveFitness` class

The `ec.multiobjective` package contains a single new kind of Fitness. Multiobjective optimization differs from other optimization algorithms in that the Fitness of an Individual is not a single value but rather consists of some N **objectives**, separate values describing the quality of the Individual on various aspects of the Problem. Thus the primary class overridden by multiobjective algorithms is a special version of Fitness called `ec.multiobjective.MultiObjectiveFitness`. Internally in this class the objective results are stored in an array of doubles:

```
public double[] objectives;
```

The number of objectives is the length of this array.

You create a `MultiObjectiveFitness` and define its objectives along these lines:

```
pop.subpop.0.species.fitness = ec.multiobjective.MultiObjectiveFitness
pop.subpop.0.species.fitness.num-objectives = 3
```

Though ECJ tends to assume that higher Fitness values are better, many multiobjective algorithms assume the opposite. Thus `MultiObjectiveFitness` has the option of doing either case. ECJ assumes lower objective values are better when you state:

```
pop.subpop.0.species.fitness.maximize = false
```

You can also state maximization (versus minimization) on a per-objective basis, for example:

```
pop.subpop.0.species.fitness.maximize.0 = false
pop.subpop.0.species.fitness.maximize.1 = true
```

Per-objective settings override global settings.

In any event, `true` is the default setting. Maximization settings are stored in the variable:

```
public boolean[] maximize;
```

Similarly, you can also set the minimum and maximum objective values on a per-objective basis:

```
pop.subpop.0.species.fitness.min.0 = 0.0
pop.subpop.0.species.fitness.max.0 = 2.0
pop.subpop.0.species.fitness.min.1 = 1.0
pop.subpop.0.species.fitness.max.1 = 3.5
pop.subpop.0.species.fitness.min.2 = -10
pop.subpop.0.species.fitness.max.2 = 0
```

The default minimum is 0.0 and the default maximum is 1.0. If you like you can set global minimum and maximum values instead:

```
pop.subpop.0.species.fitness.min = 0.0
pop.subpop.0.species.fitness.max = 2.0
```

Local min/max values, if set, override the global values. The resulting minimum and maximum values are stored in the following arrays:

```
public double[] minObjectives;
public double[] maxObjectives;
```

Note that these min/max arrays are *shared*¹¹ among all Fitness objects cloned from the same Prototype. So you should treat them as read-only.

You can get and set objectives via functions, which have the added benefit of double-checking their min/max validity:

ec.multiobjective.MultiObjectiveFitness Methods

```
public int getNumObjectives()
```

Returns the number of objectives.

```
public double[] getObjectives()
```

Returns all the current objective values.

```
public double getObjective(int index)
```

Returns a given objective value.

```
public void setObjectives(EvolutionState state, double[] objectives)
```

Sets the objective values to the ones provided, double-checking that they are within valid minimum and maximum ranges (discussed in a moment)

```
public double sumSquaredObjectiveDistance(MultiObjectiveFitness other)
```

Returns the sum squared distance in objective space between this Fitness and the other. That is, if for a given objective i , this fitness has value A_i and the other has value B_i , this function will return $\sum_i (A_i - B_i)^2$.

```
public double manhattanObjectiveDistance(MultiObjectiveFitness other)
```

Returns the Manhattan distance in objective space between this Fitness and the other. That is, if for a given objective i , this fitness has value A_i and the other has value B_i , this function will return $\sum_i |(A_i - B_i)|$.

Since MultiObjectiveFitness is a Prototype, of course you can define these parameters using a default parameter base. For example:

¹¹Why doesn't Fitness store them in the Species or something? Because Fitness, for historical and not particularly good reasons, does not have a Flyweight relationship with any object.

```

pop.subpop.0.species.fitness = ec.multiobjective.MultiObjectiveFitness
multi.fitness.num-objectives = 3
multi.fitness.maximize = false

# Global objectives
multi.fitness.min = 0.0
multi.fitness.max = 2.0

# Local Overrides (heck, why not?)
multi.fitness.min.1 = 1.0
multi.fitness.max.1 = 3.5
multi.fitness.min.2 = -10
multi.fitness.max.2 = 0

```

7.5.0.2 The MultiObjectiveStatistics class

To help output useful statistics about the Pareto Front, ECJ has an optional but strongly encouraged Statistics class, `ec.multiobjective.MultiObjectiveStatistics`. This class largely overrides the `finalStatistics` method to do the following:

- All the individuals forming the Front are printed to the statistics log file.
- If a separate “front log file” is specified, a whitespace-delimited table of the objective values of each member of the Front, one per line, is written to this log. If the log is not specified, they’re printed to the screen instead.

If the Front is 2-objective, and the file is called, say, `front.stat`, you can easily view the Front results by firing up GNU PLOT and entering:

```
plot front.stat
```

The `MultiObjectiveStatistics` class is used, and the Front file defined, as follows:

```
stat = ec.multiobjective.MultiObjectiveStatistics
stat.front = $front.stat
```

Keep in mind that none of this happens if the `do-final` parameter has been set to `false`. In addition to standard statistics-quieting features (see Section 3.7.3), you can also quiet the front-log writing. This is done with:

```
stat.silent.front = true
```

Various multiobjective optimization algorithms subclass from `MultiObjectiveFitness` to add auxiliary fitness values. We’d like those values to be included as columns in the Front summary when it is outputted to the screen by `MultiObjectiveStatistics`. To do this, `MultiObjectiveFitness` has two special methods which are overridden by subclasses:

ec.multiobjective.MultiObjectiveFitness Methods

```
public String[] getAuxilliaryFitnessNames()
```

Returns an array of names, one per auxiliary fitness element. These will appear as headers to their respective columns.

```
public double[] getAuxilliaryFitnessValues()
```

Returns an array of doubles, one per auxiliary fitness element, of the current values of those elements.

7.5.0.3 Measuring Hypervolume

Because multiobjective algorithms work with several competing objectives at once, their performance can be tricky to quantify as a scalar value. One popular way of expressing the quality of a Pareto front is to compute the **hypervolume** of the portion of the objective space that is dominated by the current population. In general, the larger the hypervolume, the better the Pareto front. The `ec.multiobjective` package offers two mechanisms for recording such a hypervolume over the course of a run. First, the `ec.multiobjective.MultiObjectiveStatistics` class has an option that allows us to include hypervolume as part of its output. Second, ECJ provides a statistics class that can be used to record hypervolume to an independent CSV file: `ec.multiobjective.HypervolumeStatistics`.

The easiest way to add hypervolume to an experiment's statistics is to activate it for `MultiObjectiveStatistics` like so:

```
stat = ec.multiobjective.MultiObjectiveStatistics
stat.front = $front.stat
stat.do-hypervolume = true
```

But we're not quite done yet, because hypervolume is always measured relative to a **reference point** in the multiobjective space, which we must specify in advance. If our method is minimizing, then the reference point serves as a **lower bound** on possible objective values in the Pareto front space; and if our method is maximizing, then the reference point serves as an **upper bound**. As long as the Pareto front dominates the reference point, we get a positive (and, we hope, increasing!) hypervolume.

If you know the worst fitness that is possible for each objective, then that can serve as a nice choice of an absolute reference point. If you're maximizing, then in the simplest case, a natural choice of reference point might be the origin (shown here for three objectives):

```
stat.reference-point = 0.0 0.0 0.0
```

If you don't know the actual worst possible fitnesses, you can just choose an arbitrary reference point with very poor objective values. `MultiObjectiveStatistics` will generate a fatal error if it encounters a Pareto front with negative hypervolume, so make sure your reference point is bad enough that it will never dominate the population.

We envision `HypervolumeStatistics` will typically be used as a complement to the `ec.multiobjective.MultiObjectiveStatistics` class. Thus you'd probably want to set things up like this:

```
stat = ec.multiobjective.MultiObjectiveStatistics
### ... followed by various MultiObjectiveStatistics parameter settings, and then...

stat.num-children = 1
stat.child.0 = ec.multiobjective.HypervolumeStatistics
stat.child.0.reference-point = 0.0 0.0 0.0
```

`HypervolumeStatistics` also requires an output file in which to dump its statistics:

```
stat.child.0.file = $hypervolume.out
```

Warning Note that hypervolume can be a **notoriously expensive calculation** to perform for large populations and/or large numbers of objectives! ECJ uses a hypervolume algorithm that aims at efficiency, but in some applications you may want to avoid calculating hypervolume at every generation. One simple way to do this is to simply comment out the `num-children` line:

```
### We don't want hypervolume for now.
# stat.num-children = 1
```

7.5.1 Selecting with Multiple Objectives

ECJ's primary multiobjective algorithms don't use `MultiObjectiveFitness` directly, but rather subclass it to add per-algorithm gizmos. But if you're not using these algorithms, you can still use `MultiObjectiveFitness` in a more "traditional" generational algorithm. This requires some thought: at the end of the day, ECJ needs to select based on this Fitness mechanism. But if there is more than one objective value, how is this done?

You could just sum the objectives to form a final "fitness" value of course. If your `SelectionMethod` uses the raw `fitness()` value (for example, `FitProportionateSelection` from Section 3.5.2) this is exactly what `MultiObjectiveFitness` returns.

But the most common approach is instead to use some form of **Pareto domination**. Pareto domination works like this. Individual *A* *Pareto dominates* Individual *B* if and only if *A* is *at least as good* as *B* in all objectives, and is *superior* to *B* in at least one objective. Notice that there are three cases where *A* might **not** Pareto-dominate *B*:

- *B* Pareto-dominates *A*
- *A* and *B* have exactly the same objective values for all objectives.
- *A* is superior to *B* in some objectives, but *B* is superior to *A* in other objectives.

`MultiObjectiveFitness` implements the `betterThan` and `equivalentTo`¹² methods to return pareto domination results: `betterThan` is true if the Individual Pareto-dominates the one passed in. `equivalentTo` returns true if neither Pareto-dominates the other (either of the last two cases above).

If your `SelectionMethod` relies entirely on the `betterThan` and `equivalentTo` methods (such as `TournamentSelection`), it'll use Pareto domination to sort Individuals.

Various subclasses of `MultiObjectiveFitness` for different kinds of algorithms override the `betterThan` and `equivalentTo` methods to measure fitness differently. However you can still determine Pareto Domination with the following method:

ec.multiobjective.MultiObjectiveFitness Methods

```
public boolean paretoDominates(MultiObjectiveFitness other)
    Returns true if this fitness Pareto-dominates other.
```

7.5.1.1 Pareto Ranking

An alternative method, widely used in multiobjective algorithms but not implemented in `MultiObjectiveFitness` proper, is to perform **Pareto ranking** (sometimes called *non-dominated sorting* [26], which works as follows. The **Pareto non-dominated front** (or simply **Pareto front**) is the set of Individuals in a Subpopulation who are dominated by *no one else*, including one another. All members of a Pareto front of a Subpopulation receive a ranking of 0. We then remove those members from consideration in the Subpopulation and form the Pareto front among the remaining members. These members receive a ranking of 1. We then remove *those* members from consideration as well and repeat. Ultimately every member of the Subpopulation receives a ranking. These rankings become fitness values, where lower rankings are preferred to higher rankings. Pareto ranking plays a major part in the NSGA-II algorithm (Section 7.5.2).

Here are methods for extracting the Pareto Front and various Pareto Front Ranks:

ec.multiobjective.MultiObjectiveFitness Methods

```
public static ArrayList partitionIntoParetoFront(Individual[] inds, ArrayList front, ArrayList nonFront)
    Partitions inds into the front and the non-front Individuals. If front is provided, the front Individuals are placed there and returned. If front is not provided, a new ArrayList is created, the front is placed there, and it is returned. If nonFront is provided, the non-front Individuals are placed in it, else they are discarded.
```

¹²Perhaps now it might make sense why the method is called `equivalentTo` and not `equalTo`.

```
public static ArrayList partitionIntoRanks(Individual[] inds)
    Partitions inds into Pareto Front ranks. Each rank is an ArrayList of Individuals. The ranks are then placed into an
    ArrayList in increasing order (worsening rank) starting with rank zero. This ArrayList is returned.
```

```
public static int[] getRankings(Individual[] inds)
    For each individual, returns the Pareto Front ranking of that individual, starting at 0 (the best ranking) and
    increasing with worse Pareto Front ranks. Note that though this function is O(n), it has a high constant overhead
    because it does some boxing and hashing.
```

7.5.1.2 Archives

The most common — and often most effective — multiobjective optimization algorithms are very strongly elitist, essentially versions of the $(\mu + \lambda)$ evolution strategy (Section 4.1.2). Specifically, they split the Population into two groups: the primary Population, and an **archive** consisting largely of the Pareto front of nondominated Individuals discovered so far. Any time a new Individual is discovered which dominates members of this front, those members are removed from the elitist archive and the Individual is introduced to it. ECJ has two Pareto archive multiobjective algorithms: NSGA-II and SPEA2. We discuss them next.

7.5.2 NSGA-II/III (ec.multiobjective.nsga2 and ec.multiobjective.nsga3 Packages)

The Non-dominated Sorting Genetic Algorithm Version II (or NSGA-II) [2] is essentially a version of the $(\mu + \mu)$ evolution strategy using non-dominated sorting. It maintains and updates an archive (half the population) of the current best individuals (essentially the current estimate of the Pareto Front), and breeds the remaining population from the archive.

NSGA-II requires a Breeder, `ec.mutiobjective.nsga2.NSGA2Breeder`, to maintain the archive and handle the algorithm's custom breeding; it also computes the non-dominated sorting on the fly. The non-dominated sorting information is included in the fitness, and so NSGA-II uses a subclass of `MultiObjectiveFitness` called `ec.mutiobjective.nsga2.NSGA2MultiObjectiveFitness`. To output the Pareto Front for the user, we also include a special `Statistics` subclass called `ec.mutiobjective.nsga2.NSGA2Statistics`.

Simply replace `MultiObjectiveFitness` with this class:

```
pop.subpop.0.species.fitness = ec.multiobjective.nsga2.NSGA2MultiObjectiveFitness
```

You'll need to set the number of objectives, and min/max objectives, etc., as usual, something like:

```
multi.fitness.num-objectives = 3
multi.fitness.min = 0.0
multi.fitness.max = 2.0
multi.fitness.min.1 = 1.0
multi.fitness.max.1 = 3.5
multi.fitness.min.2 = -10
multi.fitness.max.2 = 0
```

This class contains two special fitness measures: the **rank** and **sparsity** of the Individual. The rank is computed as the Pareto Rank of the individual. The sparsity is a measure of distance of the individual to others on the same rank. We like sparse individuals because we don't want individuals all clustered in one area of the front. The fitness is simple: an Individual is superior to another if its rank is lower (better). If the same, an Individual is superior if its sparsity is higher. These two measures are stored in `NSGA2MultiObjectiveFitness` as the instance variables:

```
public int rank;
public double sparsity;
```

The NSGA2Breeder performs breeding using the archive. Again, defined in the obvious way:

```
breed = ec.multiobjective.nsga2.NSGA2Breeder
```

You're responsible for setting up breeding pipelines like you see fit.

Note that although NSGA2Breeder is a subclass of SimpleBreeder, it cannot be used with elitism and will complain if you attempt to do so.

When breeding, NSGA-II assumes you're using TournamentSelection. You can do what you like selection-wise, but if you pick something other than TournamentSelection, it won't be "standard" NSGA-II.

NSGA-III NSGA-III is run in largely the same way as NSGA-II except that it is found in the ec.multiobjective.nsga3 package. Thus you would instead change the relevant parameters to:

```
pop.subpop.0.species.fitness = ec.multiobjective.nsga3.NSGA3MultiObjectiveFitness
multi.fitness.num-objectives = 3
multi.fitness.min = 0.0
multi.fitness.max = 2.0
multi.fitness.min.1 = 1.0
multi.fitness.max.1 = 3.5
multi.fitness.min.2 = -10
multi.fitness.max.2 = 0
breed = ec.multiobjective.nsga3.NSGA3Breeder
```

The big difference between NSGA-II and NSGA-III is that NSGA-III does not use sparsity. Instead it uses a special niching mechanism meant to try to distribute individuals consistently through the pareto front (so-called *reference points*). This means that NSGA-III does not have NSGA-II's sparsity variable.

Like NSGA-II, when breeding, NSGA-III assumes you're using TournamentSelection. You can do what you like selection-wise, but if you pick something other than TournamentSelection, it won't be "standard" NSGA-III.

Where to get examples The package ec.app.moosuite has NSGA-II implementations of a number of famous multiobjective test problems. Be sure to read the moosuite.params file, where you can specify that you want to use NSGA-II or NSGA-III for the problems.

The NSGA-III code is due to Ben Brumbac, a GMU graduate student.

7.5.3 SPEA2 (The ec.multiobjective.spea2 Package)

The Strength Pareto Evolutionary Algorithm 2 (SPEA2) [32] splits the Subpopulation in two two parts: the archive and the "regular" Subpopulation. Unlike the NSGA-II algorithm, this archive can vary in size. The size of the archive is a parameter in ec.multiobjective.spea2.SPEA2Subpopulation:

```
pop.subpop.0 = ec.multiobjective.spea2.SPEA2Subpopulation
pop.subpop.0.size = 100
pop.subpop.0.archive-size = 50
```

Each iteration SPEA2 updates the archive to include the Pareto front, plus (if there is room) additional fit individuals using a special domination-based fitness measure called *strength*. If there are too many Individuals to fit in the archive, the archive is trimmed by removing Individuals which are too close to one another. It then uses its special fitness measure to breed individuals from the Archive and place them into the "regular" Subpopulation.

To do this, SPEA2 needs to augment the MultiObjectiveFitness with a few additional values:

```

public double strength;
public double kthNNDistance;
public double fitness;

```

The first measure is the *strength* of an Individual, defined as the number of Individuals whom it dominates. The second measure (“distance”) is an inverted measure of how far the Individual is from other Individuals in the population. The final measure (the actual *fitness*) is the sum of the so-called SPEA2 “raw fitness” and the distance measure: higher fitness values are worse.

This version of MultiObjectiveFitness is called `ec.multiobjective.spea2.SPEA2MultiObjectiveFitness`, and we include it as well, for example,

```

pop.subpop.0.species.fitness = ec.multiobjective.spea2.SPEA2MultiObjectiveFitness
multi.fitness.num-objectives = 2
multi.fitness.min.0 = 1.0
multi.fitness.max.0 = 3.5
multi.fitness.min.1 = -10
multi.fitness.max.1 = 0

```

SPEA2 also requires a special Breeder:

```

breed = ec.multiobjective.spea2.SPEA2Breeder

```

When breeding, SPEA2 assumes you’re using `TournamentSelection`. You can do what you like selection-wise, but if you pick something other than `TournamentSelection`, it won’t be “standard” SPEA2.

Where to get examples The package `ec.app.moosuite` has SPEA2 implementations of a number of famous multiobjective test problems. Be sure to read the `moosuite.params` file, where you can specify that you want to use SPEA2 for the problems.

7.6 Estimation of Distribution Algorithms

An estimation of distribution algorithm is similar to an evolutionary algorithm in that it periodically produces individuals and assesses their fitness. However, the manner in which individuals are generated is quite different. Rather than producing individuals from a previous generation of individuals, an estimation of distribution algorithm typically maintains some kind of **distribution** from which individuals are sampled. After individuals have their fitnesses assessed, the distribution is revised to reflect the better quality individuals, and then the next generation is sampled from this revised distribution, and so on.

ECJ’s estimation of distribution package is `ec.eda`. In it there are presently three estimation of distribution algorithms:

- PBIL
- CMA-ES
- DOvS

7.6.1 PBIL

Population-based Incremental Learning (or PBIL) is a univariate estimation of distribution method.¹³ It assumes that individuals are vectors of integers (thus `ec.vector.IntegerVectorIndividual` and maintains one distribution for each gene. A gene’s distribution is simply an array of probabilities, one for each possible

¹³A basic introduction to the algorithm can be found in [10].

value that that gene could take on. To build a new individual, PBIL selects randomly from each distribution to determine the gene value for that particular gene. The distributions are updated by performing truncation selection on the population, then revising each distribution somewhat to reflect the distribution of values of its gene in the truncated population. PBIL is single-threaded in its breeding. PBIL does not have a lot of parameters:

```
## Standard ECJ Stuff
evalthreads = auto
breedthreads = auto
checkpoint-prefix = ec
checkpoint-modulo = 1
state = ec.simple.SimpleEvolutionState
init = ec.simple.SimpleInitializer
finish = ec.simple.SimpleFinisher
eval = ec.simple.SimpleEvaluator
stat = ec.simple.SimpleStatistics
stat.file = $out.stat
exch = ec.simple.SimpleExchanger
pop = ec.Population
pop.default-subpop = 0
pop.subpop.0 = ec.Subpopulation

## PBIL Specific Stuff
breed = ec.eda.pbil.PBILBreeder
pop.subpop.0.species = ec.eda.pbil.PBILSpecies
pop.subpop.0.species.ind = ec.vector.DoubleVectorIndividual

## This gunk must be set even though we don't use it.
pop.subpop.0.species.mutation-prob = 0
pop.subpop.0.species.pipe = ec.breed.InitializationPipeline
pop.subpop.0.species.mutation-type = reset
pop.subpop.0.species.crossover-type = one
# PBIL will probably not generate duplicate individuals
pop.subpop.0.duplicate-retries = 0
```

Now we need to specify the size of the population as well as the truncation selection size (similar to λ and μ in evolution strategies). And we need to specify to what degree the distribution will be updated to reflect the genes in the truncated population each time. These parameters are:

```
pop.subpop.0.size = 100
# how many individuals survive truncation?
pop.subpop.0.species.b = 50
# To what degree (0.0 ... 1.0) is the distribution updated? This should be fairly small.
pop.subpop.0.species.alpha = 0.05
```

We'll also need to provide some generations, genome information, fitnesses, and an evaluation problem, for example:

```
pop.subpop.0.species.genome-size = 10
pop.subpop.0.species.min-gene = 0
pop.subpop.0.species.max-gene = 100
pop.subpop.0.species.fitness = ec.simple.SimpleFitness
```

```

generations = 1000
eval.problem = ec.app.sum.Sum

```

There is an example application for PBIL in `ec/app/sum/pbil.params`. The PBIL code is due to Sunil Kumar Rajendran, a GMU graduate student.

7.6.2 CMA-ES

The $(\mu/\mu_W, \lambda)$ Covariance Adaptation Evolution Strategy, or CMA-ES, maintains a distribution in the form of a multivariate Gaussian distribution.¹⁴ The CMA-ES facility in ECJ consists of three classes: `ec.eda.cmaes.CMAESSpecies`, `ec.eda.cmaes.CMAESBreeder`, and `ec.eda.cmaes.CMAESInitializer`. The critical class is `ec.eda.cmaes.CMAESSpecies`, which does all the hard work. The other two largely call it to initialize the initial population (and set up the CMA-ES distribution), and to resample a subpopulation for the next generation.

As such, `ec.eda.cmaes.CMAESSpecies` has two methods of note: `newIndividual(...)` and `updateDistribution(...)`. The first samples a random individual from the distribution. The second updates the distribution to reflect the fitness values among individuals in a given subpopulation. The other big method is `setup(...)`, which does a lot of work because CMA-ES, unusually for a metaheuristic algorithm, has default values for many of its parameters determined not by constant numbers but by equations.

CMA-ES is single-threaded only.

CMA-ES only uses real-valued vector individuals, and so is restricted to using `ec.vector.DoubleVectorIndividual`. Furthermore, it does not use the population size parameter at all, preferring instead to use a (possibly computed) lambda parameter similar to other ES algorithms. You'll still have to provide a population size as it's required by ECJ: but CMA-ES will entirely ignore it. There are a few other required parameters that will be ignored as well, so we have:

```

## Standard ECJ Stuff
evalthreads = auto
breedthreads = auto
checkpoint-prefix = ec
checkpoint-modulo = 1
state = ec.simple.SimpleEvolutionState
finish = ec.simple.SimpleFinisher
eval = ec.simple.SimpleEvaluator
stat = ec.simple.SimpleStatistics
stat.file = $out.stat
exch = ec.simple.SimpleExchanger
pop = ec.Population
pop.default-subpop = 0
pop.subpop.0 = ec.Subpopulation

## CMA-ES Specific Stuff
init = ec.eda.cmaes.CMAESInitializer
breed = ec.eda.cmaes.CMAESBreeder
pop.subpop.0.species = ec.eda.cmaes.CMAESSpecies
pop.subpop.0.species.ind = ec.vector.DoubleVectorIndividual

## This gunk must be set even though we don't use it. We set the population
## size to 1 (we gotta set it to something) even though it'll be ignored.

```

¹⁴There is significant standardized source code available for CMA-ES (see <https://www.lri.fr/~hansen/cmaes.inmatlab.html>), and although it is a clean rewrite, ECJ's implementation tries to be fairly faithful to that code.

```

pop.subpop.0.size = 1
pop.subpop.0.species.mutation-prob = 0
pop.subpop.0.species.pipe = ec.breed.InitializationPipeline
pop.subpop.0.species.mutation-type = reset
pop.subpop.0.species.crossover-type = one
# CMA-ES will almost certainly not generate duplicate individuals
pop.subpop.0.duplicate-retries = 0

```

In order to get CMA-ES running, we also will need to provide at least an initial mean for our distribution. ECJ provides a few options for this. First, you can set the mean to the *center* of the space (defined by the min and max gene values of your genome). Second, you could set the mean to the *origin* ($\vec{0}$) of the space. Third, you could set the mean to a *random* position somewhere within the space bounded by the min and max gene values:

```

pop.subpop.0.species.mean = center
# other options: zero random

```

Alternatively, you can specify the precise initial mean position like this:

```

pop.subpop.0.species.mean.0 = 0.762
pop.subpop.0.species.mean.1 = -0.932
pop.subpop.0.species.mean.2 = 1.234
# ... etc.

```

Warning Beware of random: if you have a high-dimensional individual, it's likely to pick a mean fairly close to several edges in the space. This in turn will cause CMA-ES to, at least initially, generate a high number of invalid individuals, which it must reject and resample. This in turn will cause ECJ to sit and wait for quite a while before starting evolution.

To finish things, we need to provide some generations, genome information, fitnesses, and an evaluation problem, for example:

```

pop.subpop.0.species.genome-size = 11
pop.subpop.0.species.min-gene = -2.048
pop.subpop.0.species.max-gene = 2.048
pop.subpop.0.species.fitness = ec.simple.SimpleFitness
generations = 1000

eval.problem = ec.app.ecsuite.ECSuite
eval.problem.type = rosenbrock

```

You can use whatever fitness method you wish, but it must be comparable and sortable. Generally speaking, this means, don't use a multiobjective fitness.

7.6.2.1 Parameters

CMA-ES has a large number of parameters: but nearly all of them are set to default values. More importantly, and unusually, nearly all of these default values are *computed at runtime* based on your genome size and other choices. This means that you may not know what values are being used internally when running CMA-ES: so it will print out these parameters when it runs so you know what you're getting into.

Let's start with parameters you may wish to play with. First, there's the *sigma*, which defines the value of σ , a standard CMA-ES parameter which specifies the scaling of the covariance matrix. By default this is set to 1.0, but you can change it as shown below.

```
pop.subpop.0.species.sigma = 0.5
```

Second, ECJ provides a bit more control over the initial shape of the covariance matrix. Normally it's set to the identity matrix. However if you have genes with unusual min/max values this might not be a good choice, because most initial individuals will be out-of-bounds, resulting in some severe wait-times to get a valid individual. Alternatively, you can scale the covariance matrix so that its standard deviations are equal to the various min/max ranges per-gene. You might *still* want to reduce sigma as well (perhaps to 0.5?). Anyway, to do this, you say:

```
% The default is: identity
pop.subpop.0.species.covariance = scaled
```

Third, there's the question of how CMA-ES should terminate. Normally ECJ terminates when it has run out of generations or evaluations, or when it has found the ideal individual. But CMA-ES has a new wrinkle: when the eigenvalues of its covariance matrix get too small, floating-point errors can cause them to go negative, at which point the whole thing goes up in smoke. ECJ will terminate when that happens and let you know. You can alternatively terminate early when the eigenvalues get very small, by setting `alternative-termination` to true, for example:

```
pop.subpop.0.species.alternative-termination = true
```

Fourth, there's the issue of how CMA-ES should generate an individual. Ordinarily it builds an individual in the normal way, by generating one under the CMA-ES distribution. However this individual might violate min/max gene constraints, particularly early on and when the individual has many genes. This causes CMA-ES to regenerate the individual. If the probability of generating an invalid individual is high, this could effectively be an infinite loop; ECJ will eventually warn you that this might be happening. You would normally deal with this by reducing the value of sigma, or perhaps using scaled covariance matrix initialization. But another way to handle it is as follows: if, after some `altGeneratorTries` CMA-ES has failed to generate a given individual, it will instead generate the individual in the normal way, but whenever a gene violates min/max constraints, its value is just randomized uniformly to a value between the min and max values. This alternative approach would be specified as:

```
pop.subpop.0.species.alternative-generator = true
% The default here is 100
pop.subpop.0.species.alternative-generator-tries = 100
```

Next, we have lambda and mu. These define the λ and μ parameters, just as in a standard evolution strategy. However in CMA-ES, they are normally computed automatically if you don't specify them. λ is by default set to $4 + \lfloor 3 \ln n \rfloor$, where n is the genome size. And μ is by default set to $\lfloor \frac{\lambda}{2} \rfloor$. Note that this means that λ doesn't have to be a multiple of μ . We also have various **weights** $w_0 \dots w_{\mu-1}$. These are values used instead of the fitness values for the (sorted) best μ individuals in the subpopulation, and affect the resulting distribution. The default settings for each weight are $\forall i : w_i \leftarrow \frac{\ln\left(\frac{\lambda+1}{2(i+1)}\right)}{\sum_{j=0}^{\mu-1} \ln\left(\frac{\lambda+1}{2(j+1)}\right)}$.

If you don't specify weights, ECJ will use the equation above. Otherwise you have to specify *every single weight*. Furthermore, ECJ will then renormalize your weights to guarantee that they sum to 1. Using the weights, ECJ will compute a value called $\mu_{eff} = \frac{1}{\sum_{i=0}^{\mu-1} w_i^2}$, which is used in internal computation and also in the default values of additional parameters. Those include:

- `cmu`: or $c_\mu \leq 1 - c_1$. This is the so-called *rank- μ update learning rate*, and is by default set to $\min\left(1 - c_1, 2 \frac{\mu_{eff} - 2 + 1/\mu_{eff}}{(n+2)^2 + \mu_{eff}}\right)$.
- `c1`: or $c_1 \leq 1 - c_\mu$. This is the so-called *rank-1 update learning rate*, and is by default set to $\frac{2}{(n+1.3)^2 + \mu_{eff}}$.

- c_c : or $c_c \leq 1$. This is the so-called *rank-1 evolution path cumulation learning rate*, and is by default set to $\frac{4+\mu_{eff}/n}{n+4+2\mu_{eff}/n}$.
- c_σ : or $c_\sigma \leq 1$. This is the so-called *step-size control cumulation*, and is by default set to $\frac{\mu_{eff}+2}{n+\mu_{eff}+5}$.
- d_σ : or $d_\sigma \leq 1$. This is the so-called *update dampening of the step-size control*, and is by default set to $c_\sigma + 2 \max\left(1, \sqrt{\frac{\mu_{eff}-1}{n+1}}\right) - 1$.

Normally you wouldn't play with any of these parameters, but if you wanted to set them, you can as:

```
# pop.subpop.0.species.lambda =
# pop.subpop.0.species.mu =
# pop.subpop.0.species.cc =
# pop.subpop.0.species.cs =
# pop.subpop.0.species.c1 =
# pop.subpop.0.species.cmu =
# pop.subpop.0.species.damps =

# pop.subpop.0.species.weight.0 =
# pop.subpop.0.species.weight.1 =
# ... and so on ...
```

There is an example parameter file, `ec/app/ecsuite/cmaes.params`, located in the `ecsuite` application, which you can try. The CMA-ES code is due to Sam McKay, a GMU undergraduate student.

7.6.3 iAMaLGaM IDEA

The Adapted Maximum-Likelihood Gaussian Model Iterated Density-Estimation Evolutionary Algorithm (iAMaLGaM IDEA) is an EDA in the same vein as CMA-ES, and likewise ECJ's implementation of it is set up in a manner very similar to how ECJ does CMA-ES. Like CMA-ES, iAMaLGaM IDEA has its own breeder and species; but unlike CMA-ES, iAMaLGaM IDEA does not have its own specialized initializer.

The critical class is `ec.eda.amalgam.AMALGAMSpecies`, which does the heavy lifting. Like the CMA-ES version, this one has two primary methods, `newIndividual(...)` and `updateDistribution(...)`. The first samples a random individual from the distribution. The second updates the distribution to reflect the fitness values among individuals in a given subpopulation. iAMaLGaM IDEA is single-threaded only. iAMaLGaM IDEA only uses real-valued vector individuals, and so is restricted to using `ec.vector.DoubleVectorIndividual`. Thus we might start with something like this:

```
## Standard ECJ Stuff
evalthreads = auto
breedthreads = auto
seed.0 = time
quit-on-run-complete = true
checkpoint-prefix = ec
checkpoint-modulo = 1
state = ec.simple.SimpleEvolutionState
init = ec.simple.SimpleInitializer
finish = ec.simple.SimpleFinisher
eval = ec.simple.SimpleEvaluator
stat = ec.simple.SimpleStatistics
stat.file = $out.stat
```

```

exch = ec.simple.SimpleExchanger
pop = ec.Population
pop.default-subpop = 0
pop.subpops = 1
pop.subpop.0 = ec.Subpopulation
pop.subpop.0.duplicate-retries = 0
pop.subpop.0.size = 30
generations = 1000
pop.subpop.0.species.ind = ec.vector.DoubleVectorIndividual
pop.subpop.0.species.fitness = ec.simple.SimpleFitness

## Sample Problem Parameters, just like an ECJ vector problem
pop.subpop.0.species.genome-size = 10
pop.subpop.0.species.max-gene = 2.048
pop.subpop.0.species.min-gene = -2.048

## AMaLGaM-IDEA Specific Stuff
breed = ec.eda.amalgam.AMALGAMBreeder
pop.subpop.0.species = ec.eda.amalgam.AMALGAMSpecies

```

iAMaLGaM IDEA does its own breeding, and doesn't use pipelines at all. Furthermore it doesn't use ECJ's mutation or breeding. So we'll use the following unused defaults because ECJ needs *something*:

```

pop.subpop.0.species.pipe = ec.breed.InitializationPipeline
pop.subpop.0.species.mutation-prob = 0
pop.subpop.0.species.mutation-type = reset
pop.subpop.0.species.crossover-type = one

```

iAMaLGaM IDEA has several custom parameters which have standard defaults, and several other parameters whose values can be set but are normally computed from the custom parameters. Specifically:

Item	Default	Description
τ	0.35	Proportion of elite individuals
Variance Tolerance	0.0	iAMaLGaM IDEA terminates if the variance is less than this amount
δ^{AMS}	2.0	Controls how much selected individuals are shifted
η^{DEC}	0.9	Degree to which the distribution multiplier is decreased in certain conditions
θ^{SDR}	1.0	Threshold for the standard deviation ratio
NIS^{MAX}	$25 + \text{genome size}$	Number of generations with no improvement beyond which the distribution multiplier begins to decrease
α^{AMS}	$\frac{\tau}{2} \times \frac{\text{subpopulation size}}{\text{subpopulation size}-1}$	Proportion of individuals to be shifted in the direction of the anticipated mean shift
η^{Shift}	$1 - e^{\frac{-1.2 \times \tau \times \text{subpopulation size} ^{0.31}}{\text{genome size}^{0.5}}}$	Proportion of elite individuals
η^{Σ}	$1 - e^{\frac{-1.1 \times \tau \times \text{subpopulation size} ^{1.20}}{\text{genome size}^{1.6}}}$	Learning rate of the covariance matrix

The parameters for these, which if unset use the defaults above, are:

```

### Standard customizable parameters with defaults if you don't set them
amalgam.species.tau = ...
amalgam.species.variance-tolerance = ...

```

```

amalgam.species.delta-ams = ...
amalgam.species.eta-dec = ...
amalgam.species.theta-sdr = ...

### Additional parameters. These are computed automatically from the above parameters
### if you don't set them
amalgam.species.nis-max = ...
amalgam.species.alpha-ams = ...
amalgam.species.eta-shift = ...
amalgam.species.eta-sigma = ...

```

All nine of the above parameters can of course also be defined as:

```

### Standard customizable parameters with defaults if you don't set them
pop.subpop.0.species.tau = ...
pop.subpop.0.species.variance-tolerance = ...
pop.subpop.0.species.delta-ams = ...
pop.subpop.0.species.eta-dec = ...
pop.subpop.0.species.theta-sdr = ...

### Additional parameters. These are computed automatically from the above parameters
### if you don't set them
pop.subpop.0.species.nis-max = ...
pop.subpop.0.species.alpha-ams = ...
pop.subpop.0.species.eta-shift = ...
pop.subpop.0.species.eta-sigma = ...

```

Last, iAMaLGaM IDEA has a few custom termination conditions which ECJ can apply beyond the traditional ones (number of generations exceeded, ideal fitness discovered). You already saw one: variance-tolerance. To turn on use of these termination conditions, you say:

```
amalgam.species.alternative-termination = true
```

There is an example parameter file, `ec/app/ecsuite/amalgam.params`, located in the `ecsuite` application, which you can try. The iAMaLGaM IDEA code is due to Sam McKay, a GMU undergraduate student.

7.6.4 DOvS

WARNING: EJC's DOvS code is in early preview and is not ready for serious use yet.

Discrete Optimization via Simulation, or DOvS [30, 31], increasingly divides up the space into smaller and smaller regions in the search for regions with high-performing samples. Obviously this implies that the original space is bounded (and DOvS assumes it's closed and convex).

DOvS is designed for scenarios with high degrees of noise in fitness assessment, and thus where individuals must be tested many times to obtain an accurate reading. The question is which individuals are worth assessing more times than others. Additionally, DOvS is meant for *discrete vector* spaces, rather than continuous ones, where the gradient is not likely to be assessable. Finally, DOvS assumes a *constrained* space, where each individual \vec{x} must meet the constraint $A\vec{x} \leq \vec{b}$ for some matrix A and vector \vec{b} .

The DOvS family is conceptually simple and closely related to an EDA: it maintains *most promising area* (MPA) subset of the search space, as well as an *active set* consisting of those individuals tested in the past which happen to fall within the MPA, including the *best known individual*. The algorithm works as follows. We start with an initial user-provided individual as a starting point: this individual is assessed and forms both the best known individual the active set. We build an MPA around this individual (perhaps infinite in size). We then repeat as follows. From within the MPA we sample a new *population* of individuals. We

then assess the population as well as members of the active set. This may produce a new best individual. From the current results of the active set and population we build a new MPA. We then update the active set according to this new MPA, and repeat.

There are several DOvS methods for building the MPA: the one ECJ implements is the *Adaptive Hyperbox* algorithm. Here the MPA is a hyperbox built as follows. For each dimension d , let x_d be the value of dimension d in individual x . Also let the best individual be x^* . The *lower bound* for d is the maximum value of d over all individuals x in the active set or population, except for x^* . If this value is equal to or greater than x_d^* , it is revised to $-\infty$. Similarly, the *upper bound* for d is the minimum value of d over all individuals x in the active set or population, except for x^* . If this value is equal to or less than x_d^* , it is revised to $+\infty$. Collectively these bounds form the edges of a hyperbox surrounding x^* , but not touching it. This hyperbox is the new MPA. We sample uniformly from within it to form the next-generation population.

Adaptive Hyperbox is extremely aggressive in its exploitation — it would be hard to call it a global search algorithm — and so is probably best used after searching globally using another method.

To use DOVs, you'd include the file `ec/eda/dovs/dovs.params`. This parameter file defines many of the basic elements for you. Let's go through them. First off, we define certain special evolutionary objects:

```
init = ec.eda.dovs.DOVSSerializer
breed = ec.eda.dovs.DOVSBreeder
eval = ec.eda.dovs.DOVSEvaluator
pop.subpop.0.species = ec.eda.dovs.HyperboxSpecies
pop.subpop.0.species.ind = ec.vector.IntegerVectorIndividual
pop.subpop.0.species.fitness = ec.eda.dovs.DOVSSFitness
```

Your species must be some subset of `ec.eda.dovs.DOVSSpecies`: at present `ec.eda.dovs.HyperboxSpecies` is the only option.

Now we need to set up some basic parameters. First we need to specify the minimum number of evaluations an individual will receive in order to get a basic idea of fitness. Good individuals which stay within the MPA will receive more evaluations than this.

```
pop.subpop.0.species.initial-reps = 1
```

Next we state whether the fitness assessments are stochastic. By default we'll assume not:

```
pop.subpop.0.species.stochastic = false
```

The following parameter specifies how often the best individual is mutated and resampled as part of breeding. It is essentially part of λ from an Evolution Strategies perspective:

```
pop.subpop.0.species.warmup = 10
```

Now we need to specify the constraints for our problem. For example, in the `ec/app/highdimension` example, there are ten constraints on a genome of size 5, which looks like this:

```

pop.subpop.0.species.constraints-size = 10
pop.subpop.0.species.constraints-A.0 = 1 0 0 0 0
pop.subpop.0.species.constraints-A.1 = -1 0 0 0 0
pop.subpop.0.species.constraints-A.2 = 0 1 0 0 0
pop.subpop.0.species.constraints-A.3 = 0 -1 0 0 0
pop.subpop.0.species.constraints-A.4 = 0 0 1 0 0
pop.subpop.0.species.constraints-A.5 = 0 0 -1 0 0
pop.subpop.0.species.constraints-A.6 = 0 0 0 1 0
pop.subpop.0.species.constraints-A.7 = 0 0 0 -1 0
pop.subpop.0.species.constraints-A.8 = 0 0 0 0 1
pop.subpop.0.species.constraints-A.9 = 0 0 0 0 -1
pop.subpop.0.species.constraints-b = -5000 -5000 -5000 -5000 -5000 -5000 -5000 -5000
-5000 -5000

```

Last, we'll need to specify the initial individual(s) with which to populate the population. In the `ec/app/highdimension` example this individual looks like this:

```

Number of Individuals: i1|
Individual Number: i0|
Evaluated: F
Fitness: d0|0.0|
i5|i25|i25|i25|i25|i25|

```

We include this individual (assuming he's in a file called `start.in`) as:

```
pop.subpop.0.file = start.in
```

We include a few more parameters and we're ready to go, perhaps:

```

pop.subpop.0.species.genome-size = 5
pop.subpop.0.species.min-gene = 0
pop.subpop.0.species.max-gene = 100
pop.subpop.0.size = 10
generations = 500
eval.problem = ec.app.OurTestProblem

```

Evaluating Evaluating an individual is straightforward, but with two differences. First, we never use the `evaluated` flag to prematurely terminate evaluation: we always evaluate the individuals (because they're often stochastic).

Second, instead of setting the fitness, we'll *record an observation* like this:

```

// g is our evaluated value, higher values are better: ((DOVSFitness)
ind.fitness).recordObservation(state, g);

```

Two examples using DOvS are `ec/app/singular` and `ec/app/highdimension`

7.7 Ant Colony Optimization and GRASP

Most of the metaheuristics in ECJ rely on operations that work with complete candidate solutions: whole solutions are mutated, mated, or sampled from a distribution, and only whole solutions are evaluated for their quality.

Ant Colony Optimization algorithms and related methods for combinatorial optimization (like GRASP) tend to work differently: these methods are based on *constructive* heuristics, i.e. heuristics that work with partial solutions by adding to them component-by-component.

ECJ offers a flexible framework for combinatorial optimization in the `ec/co` package. It's distinguishing feature is a special `ConstructiveProblemForm`, which enforces the idea that to define a combinatorial optimization problem you must define not only a *fitness function* for evaluating whole solutions, but also a *neighborhood* of candidate components that solutions can be built from, and a means of assigning a *heuristic value* to individual components. Describing problems in this abstract way allows us to implement a variety of combinatorial optimization algorithms without making domain-specific assumptions (like assuming that solutions represent paths on a connected graph—a limiting assumption that tends to be built into most implementations of Ant Colony algorithms).

Here we describe how to use three combinatorial optimization methods offered by ECJ:

- Ant System (AS)
- Ant Colony System (ACS)
- Greedy Randomized Adaptive Search Procedure (GRASP)

Have a look at `ec/app/knapsack` and `ec/app/tsp` for examples of how problems can be defined for use with the algorithm in `ec/co`.

7.7.1 Ant Colony Optimization

WARNING: EJC's Ant Colony code is in early preview and is not ready for serious use yet.

Ant colony optimization (ACO) is a family of algorithms that are based on the idea of incrementally building up solutions according to a heuristic function, and then having those solutions assign “pheromones” to components. Components that accrue larger amounts of pheromones are more likely to be selected during the construction of future solutions.

ECJ's ACO package is `ec/co/aco`, which is centered around the `AntSpecies` class. This is a special `Species` that coordinates the activity of typical ACO components. Specifically, `AntSpecies` contains references to the following kinds of objects:

- `PheromoneTable`: stores pheromone values for each candidate `Component`.
- `ConstructionRule`: constructs solutions (“ants”) using information from the `PheromoneTable`.
- `UpdateRule`: uses a set of solutions to modify the `PheromoneTable`.

Ant colony algorithms are very similar to estimation of distribution algorithms: instead of modifying a persistent population, they generate new solutions at each step and use them to update some auxiliary data (pheromones). To achieve this for ACO, we wire `AntSpecies` together with a few standard evolutionary algorithm components: both `SimpleEvolutionState` and `SteadyStateEvolutionState` include hooks that will ask `AntSpecies` to perform local and global pheromone updates at the appropriate times—namely by calling the special methods `updateIndividual(...)` and `updateSubpopulation(...)`.

Here we show how these pieces can be combined to create two classic ACO methods.

7.7.1.1 Ant System

Ant System [4] was one of the first ACO algorithms. It's most distinctive features are

- a stochastic construction rule based on *proportionate selection* of candidate components, and
- a update rule that uses *all* ants to lay down pheromones, according to one of three strategies: `ANT-CYCLE`, `ANT-QUANTITY`, and `ANT-DENSITY`.

Ant System is a completely generational algorithm—pheromones are only updated after all the ants in the generation have had their fitnesses evaluated—and it works well with ECJ’s distributed evaluation system. We use SimpleEvolutionState and a simplistic ConstructiveBreeder to implement Ant System’s generational dynamics.

Here we give a full example of Ant System parameters, starting from scratch. In practice, you’ll want to use the `ec/co/ant/as.params` file as a parent for your parameters to cut down on boiler plate (see the parameter files in `ec/app/knapsack` and `ec/app/tsp` for real-world examples).

We begin with the standard EA components:

```
## Standard ECJ Stuff
evalthreads = auto
breedthreads = auto
checkpoint-prefix = ec
checkpoint-modulo = 1
state = ec.simple.SimpleEvolutionState
init = ec.simple.SimpleInitializer
finish = ec.simple.SimpleFinisher
exch = ec.simple.SimpleExchanger
breed = ec.simple.SimpleBreeder
eval = ec.simple.SimpleEvaluator
stat = ec.simple.SimpleStatistics
stat.file $out.stat
pop = ec.Population
pop.subpops = 1
pop.subpop.0 = ec.Subpopulation
pop.subpop.0.duplicate-retries = 0

generations = 200
```

As you might expect, we use the population size to set the number of ants per generation:

```
pop.subpop.0.size = 20
```

Now we define some basic high-level ACO components:

```
#####
# Ant System boiler plate
#####

# AS uses ConstructiveBreeder to execute populations of ants
breed = ec.co.ConstructiveBreeder

# AntSpecies holds the construction and update rules that define ACO algorithms
pop.subpop.0.species = ec.co.ant.AntSpecies
pop.subpop.0.species.fitness = ec.simple.SimpleFitness
pop.subpop.0.species.pheromone-table = ec.co.ant.SimplePheromoneTable
```

And finally, here we use parameters specific to AntSpecies to define Ant System’s distinctive ConstructionRule and UpdateRule. We also specify that solutions will be represented as ConstructiveIndividual, which is sufficient for most simple combinatorial optimization problems.

```
#####
# Ant System details
#####
```

```

pop.subpop.0.species.ind =                ec.co.ConstructiveIndividual

pop.subpop.0.species.construction-rule =   ec.co.ant.SimpleConstructionRule
pop.subpop.0.species.construction-rule.component-selector = ec.co.ant.ProportionateComponentSelector
pop.subpop.0.species.construction-rule.component-selector.alpha = 1.0
pop.subpop.0.species.construction-rule.component-selector.beta = 1.0

pop.subpop.0.species.update-rule =         ec.co.ant.AntSystemUpdateRule
pop.subpop.0.species.update-rule.decay-rate = 0.1
pop.subpop.0.species.update-rule.deposit-rule = ANT-CYCLE

```

All that's left now is to specify the problem we wish to solve. In this case we'll define a knapsack instance. This example is the standard P01 instance from http://people.sc.fsu.edu/~jburkardt/datasets/knapsack_01/knapsack_01.html:

```

#####
# Example problem
#####
eval.problem =                ec.app.knapsack.KnapsackProblem
eval.problem.knapsack-size = 165
eval.problem.sizes =          23 31 29 44 53 38 63 85 89 82
eval.problem.values =         92 57 49 68 60 43 67 84 87 72

```

7.7.1.2 Ant Colony System

Ant Colony System (ACS) [3] differs from Ant System in three main ways:

- A “pseudo-random” proportional construction rule is used, which randomly chooses between greedy selection and proportionate selection,
- A “global” pheromone update rule uses only the *best* “ant” (either the GLOBAL-BEST or ITERATION-BEST) to lay down pheromones, and
- A “local” pheromone update rule decays the pheromones visited by each “ant” *as soon as it is generated and before* the next ant of the generation is generated.

Thanks to the local update rule, Ant Colony System is not purely generational: some pheromone updates occur at the generation boundary, but other pheromone updates occur in a steady-state fashion. As such, we use ECJ's `SteadyStateEvolutionState` to implement ACS. This optionally allows ACS to interoperate with ECJ's distributed evaluation system—producing an asynchronous, parallel variant of ACS.

Here we give a full example of the synchronous, single-threaded version of Ant Colony System, starting from scratch. As with AS, you'll actually want to use the parent parameter file to save yourself some boilerplate: `ec/co/ant/acs.params`.

We begin with the standard EA components, this time choosing the control mechanisms for steady-state EAs:

```

## Standard ECJ Stuff
evalthreads = auto
breedthreads = auto
checkpoint-prefix = ec
checkpoint-modulo = 1
#seed.0 = time
#checkpoint = false
init = ec.simple.SimpleInitializer

```

```

finish =          ec.simple.SimpleFinisher
exch = ec.simple.SimpleExchanger
breed = ec.simple.SimpleBreeder
eval = ec.simple.SimpleEvaluator
stat = ec.simple.SimpleStatistics
stat.file $out.stat
pop = ec.Population
pop.subpops = 1
pop.subpop.0 = ec.Subpopulation
pop.subpop.0.duplicate-retries = 0

## Standard steady-state EA stuff

state = ec.steadystate.SteadyStateEvolutionState
breed = ec.steadystate.SteadyStateBreeder
eval = ec.steadystate.SteadyStateEvaluator

## Must specify deselection even though ACO won't use them
steady.deselector.0 = ec.select.TournamentSelection
steady.deselector.0.size = 1

generations = 200

```

The population size sets the number of ants in a generation—that is, the number of ants we evaluate before performing the *global* update operation:

```
pop.subpop.0.size = 20
```

Now we set up the high-level ACO components, with a few tweaks to the steady-state components:

```

#####
# Ant Colony System boiler plate
#####

# AntSpecies holds the construction and update rules that define ACO algorithms
pop.subpop.0.species =          ec.co.ant.AntSpecies
pop.subpop.0.species.fitness =  ec.simple.SimpleFitness
pop.subpop.0.species.pheromone-table = ec.co.ant.SimplePheromoneTable

# To use an ACO algorithm with SteadyStateEvolutionState, we need to tell it to
# throw away the population after each generation boundary.  Otherwise it will try
# to "insert" ants into a persistent population, which is not how ACO works!
steady.empty-at-generation-boundary = True

```

And then we get to the meat of the matter: ACS's construction and update rules and their parameterization:

```

#####
# Ant System details
#####
pop.subpop.0.species.ind =          ec.co.ConstructiveIndividual

# AS uses SimpleConstructionRule to implement pseudo-random proportionate selection

```

```

pop.subpop.0.species.construction-rule =          ec.co.ant.SimpleConstructionRule
pop.subpop.0.species.construction-rule.component-selector = \
                                                    ec.co.ant.PseudorandomProportionateComponentSelector
pop.subpop.0.species.construction-rule.component-selector.prob-best = 0.5
pop.subpop.0.species.construction-rule.component-selector.alpha = 1.0
pop.subpop.0.species.construction-rule.component-selector.beta = 1.0

# Global rule for pheromone updates
pop.subpop.0.species.update-rule =                ec.co.ant.GlobalUpdateRule
pop.subpop.0.species.update-rule.rho = 0.3
# You could switch this to ITERATION-BEST if you like
pop.subpop.0.species.update-rule.best-strategy = GLOBAL-BEST

# Local update rule
pop.subpop.0.species.local-update-rule =          ec.co.ant.ACSTLocalUpdateRule
pop.subpop.0.species.local-update-rule.rho = 0.1
pop.subpop.0.species.local-update-rule.minimum-pheromone = 0.000001

```

We close with a problem definition:

```

#####
# Example Problem
#####
eval.problem =                                     ec.app.knapsack.KnapsackProblem
eval.problem.knapsack-size = 165
eval.problem.sizes =      23 31 29 44 53 38 63 85 89 82
eval.problem.values =    92 57 49 68 60 43 67 84 87 72

```

7.7.2 GRASP

GRASP [5] takes a very simple approach to combinatorial optimization: we construct solutions by greedily selecting the component with the best heuristic value at each step. Because GRASP relies entirely on heuristic information (with no concept of pheromones or distributions that are learned over time), we really only need to choose a greedy ConstructionRule to define the algorithm:

```

parent.0 = ../../simple/simple.params

breed =                                           ec.co.ConstructiveBreeder

pop.subpop.0.size =                              10
pop.subpop.0.species =                           ec.co.grasp.GraspSpecies
pop.subpop.0.species.fitness =                   ec.simple.SimpleFitness
pop.subpop.0.species.ind =                       ec.co.ConstructiveIndividual
pop.subpop.0.species.construction-rule =         ec.co.grasp.SimpleConstructionRule
pop.subpop.0.species.construction-rule.component-selector = ec.co.grasp.GreedyComponentSelector

```

As usual, here's our problem:

```

eval.problem =                                     ec.app.knapsack.KnapsackProblem
eval.problem.knapsack-size =                       165
eval.problem.sizes =                               23 31 29 44 53 38 63 85 89 82
eval.problem.values =                             92 57 49 68 60 43 67 84 87 72

```

7.8 Meta-Evolutionary Algorithms

A Meta-Evolutionary Algorithm (or Meta-EA) is an evolutionary algorithm used to optimize the parameters of a second evolutionary algorithm. Meta-EAs were originally called “Meta-GAs” (for obvious reasons), and are closely related to the concept of hyperheuristics. ECJ implements Meta-EAs in a surprisingly clean fashion, using a single subclass of Problem called `ec.eval.MetaProblem`. Interestingly, that is the *only* class in the Meta-EA facility! The Meta-EA package was developed through collaboration with Khaled Ahsan Talukder, a GMU graduate student.

In ECJ, a Meta-EA works like this. We create an ordinary evolutionary process which evolves individuals in the form of `DoubleVectorIndividuals`. These individuals’ genomes notionally contain parameter values for a second ECJ system. To test an individual, we hand it to `MetaProblem`, which fires up another ECJ system (in the same Java process) using those parameter values and runs it. This happens some N times, and the mean best fitness over those N runs becomes the fitness of the `DoubleVectorIndividual` holding those parameter values.

Note that there are at least two levels of evolution.¹⁵ First there is the evolutionary process which is optimizing the parameters. We will refer to this process as the **meta-level process**. Then there is the evolutionary process whose being run with these parameters. We will refer to this process as the **base-level process**.

Within certain constraints, you can use pretty much any EA at the meta-level or at the base level. But there are some rules. First off, the meta-level individual must be a `DoubleVectorIndividual`. We will treat this individual as a **heterogeneous individual** (see Section 5.1.1.5), which allows the Meta-EA system to use genes of different types: integers, floats, booleans, and the like. Second the meta-level fitness must be one which can respond to `setToMeanOf(...)`, and typically should be of the same kind of fitness as the base-level fitness. Generally this means: no multiobjective fitness at either level; and coevolutionary fitness might be a bit tricky. `SimpleFitness` is fine, as is `KozaFitness`.

Meta-EAs work very well in combination with ECJ’s distributed evaluator, which is good news because it’s the natural setting for using them! The idea here is to have the meta-level process as a master process, distributing meta-level individuals out to slaves, where each is tested by firing up a base-level ECJ process to assess it. And Meta-EAs also work nicely in multiple threads. This magic all works because ECJ is self-contained: ECJ processes do not interact with other ECJ processes even within the same thread.

7.8.1 The Two Parameter Files

Generally speaking, you’ll create two parameter files: a base-level parameter file and a meta-level parameter file. The base-level parameter file tells ECJ what the default parameters are for the base-level EA process (some of these parameters will be modified to reflect the meta-level individual being tested). The meta-level parameter file defines the meta-level EA process.

The first step in constructing a Meta-EA is to get the base level working on its own without any parameter optimization. This is straightforward: it’s just a standard ECJ process.

Generally you want an ordinary EA at the base level. You’ll probably want to stay away from multi-objective optimization at the base level (how do you define “best individual of run”, and its fitness, in a multiobjective setting?). You can use coevolution in some cases, but note that the best individual of run, whose fitness is extracted, will be only the best individual of Subpopulation 0. This means that cooperative coevolution doesn’t make much sense, though 2-population competitive coevolution might make sense assuming that the primary (non-foil) subpopulation is 0.

So for example, we might have a base-level EA like this:

```
#### BASE-LEVEL FILE
evalthreads = 1
breedthreads = 1
```

¹⁵You can of course have an EA which optimizes the parameters for an EA which optimizes the parameters for an EA, and so on. `MetaProblem` can handle this without much issue. But it’s a pretty rare need! So we’ll go with “two” for purposes of this discussion.

```

seed.0 =                               time
checkpoint =                             false
checkpoint-modulo =                       1
checkpoint-prefix =                       ec
state =                                  ec.simple.SimpleEvolutionState
init =                                    ec.simple.SimpleInitializer
finish =                                  ec.simple.SimpleFinisher
exch =                                    ec.simple.SimpleExchanger
breed =                                   ec.simple.SimpleBreeder
eval =                                    ec.simple.SimpleEvaluator
eval.problem =                            MyTestProblem
stat =                                    ec.simple.SimpleStatistics
stat.file =                               $out.stat
generations =                             1000
quit-on-run-complete =                    true
pop =                                     ec.Population
pop.subpops =                             1
pop.subpop.0 =                            ec.Subpopulation
pop.subpop.0.size =                       1000
pop.subpop.0.duplicate-retries =          2
pop.subpop.0.species =                    ec.vector.FloatVectorSpecies
pop.subpop.0.species.pipe =               ec.vector.breed.VectorMutationPipeline
pop.subpop.0.species.pipe.source.0 =      ec.vector.breed.VectorCrossoverPipeline
pop.subpop.0.species.pipe.source.0.source.0 = ec.select.TournamentSelection
pop.subpop.0.species.pipe.source.0.source.1 = same
pop.subpop.0.species.fitness =            ec.simple.SimpleFitness
pop.subpop.0.species.ind =                ec.vector.DoubleVectorIndividual
pop.subpop.0.species.mutation-bounded =   true
pop.subpop.0.species.min-gene =           -5.12
pop.subpop.0.species.max-gene =           5.12
pop.subpop.0.species.genome-size =        100
pop.subpop.0.species.mutation-prob =      1.0
pop.subpop.0.species.crossover-type =     one
pop.subpop.0.species.mutation-type =     gauss
pop.subpop.0.species.mutation-stdev =     0.01
select.tournament.size =                  2

```

Let's call this file **base.params**. It's nothing special. Assuming you have a Problem subclass called MyTestProblem, ECJ should run this file all by itself (independent of any meta stuff) without incident.

Next you need to create the meta-level file, where we set up evolution of a DoubleVectorIndividual. Let's call this file **meta.params**. Here's one possibility. We'll start with certain basic items (it won't run yet):

```

#### META-LEVEL FILE
evalthreads =                             1
breedthreads =                             1
seed.0 =                                   time
checkpoint =                               false
checkpoint-modulo =                         1
checkpoint-prefix =                         ec
state =                                    ec.simple.SimpleEvolutionState
init =                                    ec.simple.SimpleInitializer
finish =                                    ec.simple.SimpleFinisher
exch =                                    ec.simple.SimpleExchanger

```



```

breed =                ec.simple.SimpleBreeder
eval =                 ec.simple.SimpleEvaluator
stat =                 ec.simple.SimpleStatistics
generations =          50
quit-on-run-complete = true
pop =                  ec.Population
pop.subpops =          1
pop.subpop.0 =         ec.Subpopulation
pop.subpop.0.size =    50
pop.subpop.0.duplicate-retries = 2
pop.subpop.0.species = ec.vector.FloatVectorSpecies
pop.subpop.0.species.ind = ec.vector.DoubleVectorIndividual

# Stuff special to meta-evolution
eval.problem =         ec.eval.MetaProblem
eval.problem.file =    base.params
eval.problem.set-random = true
eval.problem.reevaluate = true
eval.problem.runs =    1
stat.file =            $meta.stat

```

Notice that we have set apart six parameters (so far) special to meta-evolution:

- The Problem must be an `ec.eval.MetaProblem`.
- `MetaProblem` has a `file` parameter which points to the `base.params` file (wherever it is). This is how the `MetaProblem` identifies what file to use to set up base-level evolutionary processes.
- The `reevaluate` parameter, typically set to `true`. This tells `MetaProblem` to reevaluate individuals even if their evaluated flag has been set. This is because meta-level evolution of individuals is stochastic — it involves firing up an ECJ process underneath — and so every time an individual is evaluated its fitness is likely to be different.
- The `set-random` parameter, typically set to `true`. This tells `MetaProblem` to override the random number seeds of the base ECJ processes it constructs and instead seed them with random numbers.¹⁶ Alternatively, you could tell the base process to seed itself using the wall clock time. This is slightly less safe as it runs the (very small) risk of having multiple parallel base processes having the same seed. To do this second option, instead of setting `set-random` to `true`, you'd say:

```

### In the Base Parameter File
seed.0 = time

```

I don't suggest it though.

- The `runs` parameter is set to the number of times you want to run a base-level ECJ process to test a certain meta-level individual. Because base-level processes are stochastic, the fitness at the meta-level is potentially very noisy. If you set this to 1, then only a single test is done: the meta-level individual's fitness is set to the best fitness of run of the base process which was run using its parameters. Otherwise

¹⁶Seeding a random number generator using random numbers from another number generator can be perilous, particularly for random number generators with simple internal seeds. But it's probably fine in this case, because the way MersenneTwister uses its seed is to build an array of 624 random numbers from that seed using a Knuth generator; we then pulse the MersenneTwister $624 \times 2 + 1$ times to prime it, at which point these numbers have been thoroughly converted and cleaned out.

multiple tests are done and the fitness of the meta-level individual is set to the mean best fitness of run of all the multiple runs performed using those parameters. **Based on our experiments [14], we suggest using a single test.**

- The `stat.file` file is set to `$meta.stat`, not `$out.stat` as usual. This is because the base-level process has `$out.stat` as its statistics file, and even if the base-level process is instructed not to write anything out to it, it'd probably be best if the two ECJ processes not write to the same file! So we renamed it to another filename.

7.8.2 Defining the Parameters

Next you'll need to specify the parameters whose values we will evolve at the meta-level. In ECJ's Meta-EA facility, every parameter value is stored as a double in a heterogeneous (Section 5.1.1.5) `DoubleVectorIndividual`. However there are a variety of ways these doubles are interpreted:

- *Type: float* As a double (of course) between some min value and max value inclusive.
- *Type: integer* As an integer between some min value and max value inclusive.
- *Type: boolean* As a boolean (either the string `true` or `false`), represented in the genome by the values 0 and 1.
- *(no type name)* As one of M strings, represented in the genome by the values $0 \dots M - 1$.

A great many, though not all, ECJ parameters can be represented by one of the above options. To represent a parameter, you'll need to specify its gene form for the heterogeneous `DoubleVectorIndividual`, and you'll also need to specify the parameter name and other information about how the parameter is to be interpreted.

Let's say that you have chosen to evolve the following parameters:

- `pop.subpop.0.species.mutation-prob` A double-valued number ranging from 0.0 to 1.0 inclusive.
- `pop.subpop.0.species.mutation-type` One of the following strings: `reset gauss polynomial`
- `pop.subpop.0.species.mutation-stdev` A double-valued number ranging from (let's say) 0.0 to 1.0 inclusive.
- `pop.subpop.0.species.mutation-distribution-index` An integer ranging from 0 to 10 inclusive.
- `pop.subpop.0.species.alternative-polynomial-version` A boolean value, that is, one of the strings `true false`

Let's start by setting up some some default mutation and crossover information for our meta-level individuals:

```
### In the Meta Parameter File
pop.subpop.0.species.min-gene = 0.0
pop.subpop.0.species.max-gene = 1.0
pop.subpop.0.species.mutation-prob = 0.25
pop.subpop.0.species.mutation-type = gauss
pop.subpop.0.species.mutation-stdev = 0.1
pop.subpop.0.species.mutation-bounded = true
pop.subpop.0.species.out-of-bounds-retries = 100
pop.subpop.0.species.crossover-type = one
```

Now we need to define information about each of the parameters. Note that in each case we define the *name* of the parameter, and the *type* of the parameter. We also define some mutation features; different parameter types should be mutated in the appropriate way.

We start with the number of parameters and the genome size (which will be the same thing, namely 5):

```
### In the Meta Parameter File
pop.subpop.0.species.genome-size = 5
eval.problem.num-params = 5
```

Now the first parameter. It's a double, so its type is float (for "floating-point type"). We'll use the default mutation settings (gaussian, 0.25 probability, 0.1 standard deviation, bounded to 0...1) for this gene, so we don't specify anything special.

```
### In the Meta Parameter File
eval.problem.param.0 = pop.subpop.0.species.mutation-prob
eval.problem.param.0.type = float
```

Next the mutation-type parameter is one of 3 possible strings, represented in the genome as the integers 0 ... 2. For this kind of parameter we don't declare a type, but instead declare the number of values it can take on and what those values (as strings) are. Additionally, since it's represented as an integer internally, we define the maximum gene to be 2 (the minimum gene was already declared in the defaults as 0). And we use integer-reset mutation, which is the appropriate mutation for genes of this type.

```
### In the Meta Parameter File
eval.problem.param.1 = pop.subpop.0.species.mutation-type
eval.problem.param.1.num-vals = 3
eval.problem.param.1.val.0 = reset
eval.problem.param.1.val.1 = gauss
eval.problem.param.1.val.2 = polynomial
pop.subpop.0.species.max-gene.1 = 2
pop.subpop.0.species.mutation-type.1 = integer-reset
```

The standard deviation parameter is also floating-point, ranging from 0...1, like the first parameter was.

```
### In the Meta Parameter File
eval.problem.param.2 = pop.subpop.0.species.mutation-stdev
eval.problem.param.2.type = float
```

The mutation distribution index parameter is an integer which can range from 0 to 10 inclusive, hence our max gene value below (remember that the min gene value was declared in the defaults already to be 0). Unlike the mutation-type parameter, which has three unrelated strings, here the integers have an explicit ordering: 5 is closer to 6 than it is to 9. For integer values of this kind it's probably more appropriate to use something like integer-random-walk mutation than integer-reset mutation.

```
### In the Meta Parameter File
eval.problem.param.3 = pop.subpop.0.species.mutation-distribution-index
eval.problem.param.3.type = integer
pop.subpop.0.species.max-gene.3 = 10
pop.subpop.0.species.mutation-type.3 = integer-random-walk
pop.subpop.0.species.random-walk-probability.3 = 0.8
```

Finally, the alternative polynomial version parameter is a boolean value (a string of the form true or false). Booleans will be represented internally as integers (0 or 1), and integer-reset is the most appropriate form. Since the default min and max values are already 0.0 and 1.0, there's no need to define them.

```
### In the Meta Parameter File
eval.problem.param.4 = pop.subpop.0.species.alternative-polynomial-version
eval.problem.param.4.type = boolean
pop.subpop.0.species.mutation-type.4 = integer-reset
```

Note that `integer-reset` randomizes the value. This isn't very efficient if you only have boolean values (just 0 or 1): there's a 50% chance that `integer-reset` does nothing at all, right? Nope. Recall that we set `pop.subpop.0.species.out-of-bounds-retries = 100`. This means that if we're presently a 0, then ECJ will try resetting the gene up to 100 times until it sets it to a 1. So in this case `integer-reset` is more or less bit-flip mutation.

In every case, note that we define both parameters (`eval.problem.n...`) and corresponding gene information (`pop.subpop.0.species...n`). You need to make sure that the right kind of parameter types match up with the right kinds of gene types.

7.8.3 Statistics and Messages

Meta-EAs can be chatty: you're running lots of base-level ECJ processes and they're writing out all sorts of messages to the screen. Furthermore, these processes are probably writing statistics files that are unnecessary and significantly slow them down. Once you've got things debugged and working well, it's probably best to shut the base-level ECJ processes up before doing your big run.

Let's start with eliminating the base-level ECJ statistics file. If you're using `SimpleStatistics`, it normally creates a file and starts writing it. But if you say:

```
### In the Base Parameter File
stat.silent = true
```

... this will prevent this behavior even if the file name was defined in the base-level parameters.

Next, your base-level ECJ process will write all sorts of things to the screen. The aforementioned `stat.silent` parameter will quiet some of them but not all of them. To completely shut the base-level ECJ process up, you can set up things so that the `stdout` and `stderr` logs of the base-level ECJ process are completely silenced. This is defined at the base-level again

```
### In the Base Parameter File
silent = true
```

In addition to the best fitnesses of N runs, used to determine the fitness of a meta-level individual, the Meta-EA system also keeps track of the best base-level individual discovered in any run each meta-level generation, and ultimately the best base-level individual ever discovered.

The best base-level individual is printed out via the `MetaProblem`'s `describe(...)` method. Ordinarily such individuals are only printed out to the statistics file at the very end of the run; but you also have the option of printing them out once every generation (which we suggest you do) with:

```
### In the Meta Parameter File
stat.do-per-generation-description = true
```

See Section 5.2.3.5 for more information on this parameter.

7.8.4 Populations Versus Generations

One very common parameter setting you may wish to evolve with a Meta-EA is how big you'd like your Population to be, where the number of generations shrinks as the Population grows so as to maintain a constant number of evaluations. Unfortunately by default ECJ treats the population size (or more properly, subpopulation sizes) and the number of generations as separate parameters.

But there's an easy way around that. All you do is define your evolution in terms of number of evaluations rather than generations. Let's say that you have a fixed budget of 64K (65536) evaluations. You can set various population sizes and let ECJ modify the generations appropriately like this:

```
### In the Base Parameter File
evaluations = 65536
```

```

### In the Meta Parameter File
eval.problem.param.3 = pop.subpop.0.size
eval.problem.param.3.num-vals = 5
eval.problem.param.3.val.0 = 16
eval.problem.param.3.val.1 = 32
eval.problem.param.3.val.2 = 64
eval.problem.param.3.val.3 = 128
eval.problem.param.3.val.4 = 256
pop.subpop.0.species.mutation-type.3 = integer-random-walk
pop.subpop.0.species.random-walk-probability.3 = 0.5

```

Because we've fixed the evaluations parameter, and are varying the `pop.subpop.0.size` parameter, the generations parameter is automatically inferred from the other two.

Note that we've set the population sizes to numbers which divide evenly into the desired number of evaluations (in this case, powers of 2). This is important so that when the number of generations is chosen, the total number of evaluations stays constant (ECJ rounds the evaluations down if it can't divide the population size evenly into them). Also note that even though the parameters are strings, we've chosen to still use `integer-random-walk`, with a low probability, rather than reset mutation. You might ponder why.

7.8.5 Using Meta-Evolution with Distributed Evaluation

Because of its high cost, almost certainly the most common usage of a Meta-EA is in a massively parallel setting. The general idea is to farm out the base-level processes to remote slaves. To do this, we take advantage of ECJ's master-slave evaluator. Before we go further, you should familiarize yourself with the master-slave distributed evaluator, in Section 6.1.

The meta-level evolution will take place on the master. The master will then ship meta-level individuals to slaves, which will then hand them to the `MetaProblem` to fire up a base-level process to test them:

```

### In the Meta Parameter File
eval.masterproblem = ec.eval.MasterProblem
eval.master.port = 5000
eval.masterproblem.job-size = 1
eval.masterproblem.max-jobs-per-slave = 1
eval.compression = true
eval.master.host = my.machine.ip.address

```

Some notes. First note that you must replace `my.machine.ip.address` in `eval.master.host` with the IP address of your master computer. Second, notice the job size and maximum number of jobs per slave are both set to 1. You almost certainly want this because the evaluation time is so long on the slaves: it's an entire evolutionary process. You probably don't want to bulk up multiple jobs per slave, though you theoretically could if your evolutionary processes were very short.

Your slave's parameter file is a new file called, let's say, **slave.params**. Note that it points to **meta.params** in order to grab some of the master's parameters.

```

### In the Slave Parameter File
# This file is run like this:
# java ec.eval.Slave -file slave.params
parent.0 = meta.params

```

Not complicated! However, in addition to various muzzling parameters (`stat.silent`, `eval.problem.silent`, etc) you probably had added to your meta parameter file, you might also want to add the following to your slave parameter file:

```
### In the Slave Parameter File
eval.slave.silent = true
```

This tells the slave to be completely silent when starting up and printing slave information. It's often a good idea. Once again, you'd do this only when you've got everything debugged.

There is one important gotcha involved with combining meta-EAs with distributed evaluation, and that is the matter of tests. The meta-EA does some N tests of a single meta-level individual in order to assess its fitness, and each test is a base-level evolutionary run. The problem is that these tests are performed by the `MetaProblem`.

Here's the issue. Let's say you have 1000 machines at your disposal. You want to distribute an entire generation to these 1000 machines, and so you have decided to do 10 tests per meta-level individual, and to have a population of 100. So in the meta parameter file, we've set `eval.problem.runs = 10` to turn on those tests.

Sounds great, right? Not so fast. The master-slave evaluator will distribute your 100 individuals out to 100 machines. Because the `MetaProblem` resides on the *slave machines*, each of those 100 machines will do 10 tests, while the other 900 machines stand by idle.

The problem is that ECJ is distributing the tests happens *after* the distribution out to the slaves. We need a way to break up the tests before slave distribution. The simplest way to do this is to use a different way of doing tests: `SimpleEvaluator`'s `num-tests` mechanism. We turn off tests in the `MetaProblem` (set it to 1) and instead turn on tests in the `SimpleEvaluator`. `SimpleEvaluator` also gives us options about how to merge those tests: we'll stick with averaging like before:

```
### In the Meta Parameter File
eval.problem.runs = 1
eval.num-tests = 10
eval.merge = mean
```

What's going on here exactly? When the `SimpleEvaluator` is told to evaluate its population, what it will do in this case is create a *new population* that is ten times the size of the old one. It then clones all the old population members ten times each and inserts them in the new population. Then it evaluates this new population. Finally, it gathers each of the ten clones and merges their fitnesses and reinserts the resulting fitness back into the original individual.

This hack helps us because when `SimpleEvaluator` has already made ten copies of each individual before it starts evaluating them. Thus each copy will get shipped off to a separate slave machine. Problem solved!

If you aren't using `SimpleEvaluator` at the meta-level, you're out of luck with this approach. But it's not hard to code a similar procedure in your own `Evaluator` subclass. For hints, see `SimpleEvaluator`'s private `expand(...)` and `contract(...)` methods.

7.8.6 Customization

It may be the case that the four parameter types aren't sufficient for your purposes. Never fear! You can override certain protected methods in `MetaProblem` to customize how parameters are mapped from the genome to parameter strings in the base-level database.

For each parameter, `MetaProblem` needs to store the name of the parameter and the kinds of values which the parameter may be set to. `MetaProblem` performs mapping as follows. During `setup(...)`, it calls a protected method called `loadDomain(...)`, which reads the parameters and stores the type of the values for of each parameter, storing them all in a instance variable:

```
public Object[] domain;
```

Once built, this array does not change, and is shared among all instances of `MetaProblem` cloned from the same prototype. The array contains, for each parameter (and hence each gene in the genome), an object which indicates the parameter's value type:

- `double[0]` Double floating-point values.
- `int[0]` Integer values.
- `boolean[0]` Boolean values (mapped to 0 and 1 for false and true)
- `String[...]` An array of strings which are valid parameter values. These are mapped to the integers 0 ... `String.length - 1`

The first three cases simply identify the type as being a double, an int, or a boolean. The last case actually identifies all the valid strings the parameter may take on. In the case of a double or an int, we also need to know the minimum and maximum values. The minimum and maximum values for parameter number *i* are determined by the `minGene(...)` and `maxGene(...)` values called on the `Species` of the corresponding genome, passing in *i*.

During `setup(...)`, the `MetaProblem` also loads a `ParameterDatabase` from the base parameter file. To evaluate a meta-level individual, it will copy this `ParameterDatabase` and then modify some of its parameters to reflect the settings in the meta-level individual. The modification procedure is done via the method `modifyParameters(...)`, which is passed the individual and the database to modify.

To modify the database, `modifyParameters(...)` must first map this individual into the proper parameter value strings. It does this by repeatedly calling the method `map(...)`, passing in the `EvolutionState`, the genome, the index of the gene of interest, and the `Species` (a `FloatVectorSpecies`). The `Species` is passed in to enable `map(...)` to call `minGene(...)` and `maxGene(...)` if necessary. `map(...)` will also certainly use the domain instance variable, of course. This method returns a `String` which holds the parameter value corresponding to the gene's numerical value.

`modifyParameters(...)` also must identify the parameter names: it does this by consulting the meta-level `ParameterDatabase` to identify the parameter names. To do this, `modifyParameters(...)` must know the parameter base underlying the parameter names. This is stored in the variable:

```
public Parameter base;
```

(Forgive the overriding of the terms "base" and "parameter" here). For example, the name of base parameter 1 is:

```
base.push(P_PARAM).push("1")
```

All of these are opportunities for you to customize the parameter loading facility. For example, if you need another kind of parameter type, you'd override `loadDomain(...)` to load new kinds of information into the domain array, and then override `map(...)` to map genes using this new kind of parameter to appropriate strings.

Finally, `modifyParameters(...)` gives you nearly full control over the mapping process. But note that if you override `modifyParameters(...)`, you'll also need to override `describe(...)` in a similar fashion. See the source code for `MetaProblem` to work through this, including certain locks. `describe(...)` normally prints out the parameters and values corresponding to the given `Individual`, then also prints out the best underlying (base-level) individual discovered, which is stored in the array...

```
public Individual bestUnderlyingIndividual[]; // per subpopulation
```

One last method you might be interested in overriding: `combine(...)`. This method is responsible for taking multiple fitness results and combining them into a final fitness for a meta-level individual. The default form calls `fitness.setToMeanOf(...)` to combine them using their average. But you can change this if you like.

ec.eval.MetaProblem Methods

```
protected void loadDomain(EvolutionState state, Parameter ase)
    Constructs the domain array from the given parameter database.
```

```

public void modifyParameters(EvolutionState state, ParameterDatabase database, int run, Individual metaIndividual)
    Given a ParameterDatabase to modify, and an Individual, extracts the parameters from the individual and sets
    them in the database. The Individual is normally a DoubleVectorIndividual.

public void describe(EvolutionState state, Individual ind, int subpopulation, int threadnum, int log)
    Given an Individual, extracts the parameters from the individual and prints them and their values to the log.
    Then prints the best "underlying individual" so far (the fittest base-level Individual discovered). The Individual is
    normally a DoubleVectorIndividual.

protected String map(EvolutionState state, double[] genome, FloatVectorSpecies species, int index)
    Given a genome and gene index, maps the gene into a String value corresponding to a base-level parameter and
    returns it.

public void combine(EvolutionState state, Fitness[] runs, Fitness finalFitness)
    Combines multiple fitness values into a single final fitness, typically by setting it to their mean.

```

7.9 Resets (The ec.evolve Package)

The ec.evolve package presently contains a single class, ec.evolve.RandomRestarts. This is a subclass of Statistics which performs random or timed restarts. RandomRestarts reinitializes your entire Population either once every fixed N generations or once every M generations where M is a random integer between 1 and N inclusive. The value of M is randomized each reset.

To use RandomRestarts, include it as part of your Statistics chain. For example, if you have a single Statistics object at present, you could say:

```

stat.num-children = 1
stat.child.0 = ec.evolve.RandomRestarts

```

Next you need to specify N . Here we set it to 20.

```

stat.child.0.restart-upper-bound = 20

```

You'll also need to state whether we reset exactly every N generations in some random number of generations between 1 and N inclusive (this random value changes every reset). The options are `fixed` and `random`. Here we set the reset type to `fixed`:

```

stat.child.0.restart-type = fixed

```

Last, you'll need to state the generation in which resetting begins. By default, this is generation 1 (after all, in generation 0 either the population was randomly generated to start with, or you specifically had loaded it from a file). But you can set it to any value ≥ 0 . To set it to generation 4, you'd say:

```

stat.child.0.start = 4

```

Resetting occurs just before evaluation. Thus a new generation may be bred, then entirely thrown away and replaced with a reset population.

One common use for resets is to randomize the population every single generation so as to do random search. You can do it like this:

```

stat.child.0.restart-upper-bound = 1
stat.child.0.restart-type = fixed
# This is the default anyway so it's not necessary to state this:
stat.child.0.start = 1

```

Random Restarts is due to James O'Beirne, a student at GMU.

Bibliography

- [1] Kumar Chellapilla. A preliminary investigation into evolving modular programs without subtree crossover. In John R. Koza, Wolfgang Banzhaf, Kumar Chellapilla, Kalyanmoy Deb, Marco Dorigo, David B. Fogel, Max H. Garzon, David E. Goldberg, Hitoshi Iba, and Rick Riolo, editors, *Genetic Programming 1998: Proceedings of the Third Annual Conference*, pages 23–31, University of Wisconsin, Madison, Wisconsin, USA, 22-25 July 1998. Morgan Kaufmann.
- [2] Kalyanmoy Deb, Amrit Pratap, Sameer Agarwal, and T. Meyarivan. A fast elitist non-dominated sorting genetic algorithm for multi-objective optimization: NSGA-II. In Marc Schoenauer, Kalyanmoy Deb, Günther Rudolph, Xin Yao, Evelyne Lutton, Juan Julian Merelo, and Hans-Paul Schwefel, editors, *Parallel Problem Solving from Nature (PPSN VI)*, pages 849–858. Springer, 2000.
- [3] Marco Dorigo and Luca Maria Gambardella. Ant colony system: a cooperative learning approach to the traveling salesman problem. *IEEE Transactions on evolutionary computation*, 1(1):53–66, 1997.
- [4] Marco Dorigo, Vittorio Maniezzo, Alberto Colorni, et al. Ant system: optimization by a colony of cooperating agents. *IEEE Transactions on Systems, man, and cybernetics, Part B: Cybernetics*, 26(1):29–41, 1996.
- [5] Thomas A Feo and Mauricio GC Resende. Greedy randomized adaptive search procedures. *Journal of global optimization*, 6(2):109–133, 1995.
- [6] John R. Koza. *Genetic Programming: On the Programming of Computers by Means of Natural Selection*. MIT Press, 1992.
- [7] John R. Koza. *Genetic Programming II: Automatic Discovery of Reusable Programs*. MIT Press, 1994.
- [8] W. B. Langdon. Size fair and homologous tree genetic programming crossovers. In Wolfgang Banzhaf, Jason Daida, Agoston E. Eiben, Max H. Garzon, Vasant Honavar, Mark Jakiela, and Robert E. Smith, editors, *Proceedings of the Genetic and Evolutionary Computation Conference*, volume 2, pages 1092–1097, Orlando, Florida, USA, 13-17 July 1999. Morgan Kaufmann.
- [9] Sean Luke. Genetic programming produced competitive soccer softbot teams for robocup97. In John R. Koza, Wolfgang Banzhaf, Kumar Chellapilla, Kalyanmoy Deb, Marco Dorigo, David B. Fogel, Max H. Garzon, David E. Goldberg, Hitoshi Iba, and Rick Riolo, editors, *Genetic Programming 1998: Proceedings of the Third Annual Conference*, pages 214–222, University of Wisconsin, Madison, Wisconsin, USA, 1998. Morgan Kaufmann.
- [10] Sean Luke. *Essentials of Metaheuristics*. 2009. Available at <http://cs.gmu.edu/~sean/book/metaheuristics/>.
- [11] Sean Luke, Cladio Cioffi-Revilla, Liviu Panait, Keith Sullivan, and Gabriel Balan. MASON: A multiagent simulation environment. *Simulation*, 81(7):517–527, July 2005.

- [12] Sean Luke and Liviu Panait. A survey and comparison of tree generation algorithms. In Lee Spector, Erik D. Goodman, Annie Wu, W. B. Langdon, Hans-Michael Voigt, Mitsuo Gen, Sandip Sen, Marco Dorigo, Shahram Pezeshk, Max H. Garzon, and Edmund Burke, editors, *Proceedings of the Genetic and Evolutionary Computation Conference (GECCO-2001)*, pages 81–88, San Francisco, California, USA, 7–11 July 2001. Morgan Kaufmann.
- [13] Sean Luke and Liviu Panait. A comparison of bloat control methods for genetic programming. *Evolutionary Computation*, 14(3):309–344, Fall 2006.
- [14] Sean Luke and A. K. M. Khaled Ahsan Talukder. Is the meta-ea a viable optimization method? In *Proceedings of the 15th Annual Conference on Genetic and Evolutionary Computation (GECCO 2013)*, 2013.
- [15] Makato Matsumoto and Takuji Nishimura. Mersenne twister: a 623-dimensionally equidistributed uniform pseudo-random number generator. *ACM Transactions on Modeling and Computer Simulation*, 8(1):3–30, 1998.
- [16] Una-May O’Reilly. *An Analysis of Genetic Programming*. PhD thesis, Carleton University, Ottawa-Carleton Institute for Computer Science, Ottawa, Ontario, Canada, 22 September 1995.
- [17] Liviu Panait. A comparison of two competitive fitness functions. In *GECCO 2002: Proceedings of the Genetic and Evolutionary Computation Conference*, pages 503–511. Morgan Kaufmann Publishers, 2002.
- [18] Ricardo Poli. A simple but theoretically-motivated method to control bloat in genetic programming. In *Genetic Programming, Proceedings of EuroGP’2003*, pages 204–217. Springer, 14-16 April 2003.
- [19] Riccardo Poli, William B. Langdon, and Nicholas Freitag McPhee. *A Field Guide to Genetic Programming*. Available in print from lulu.com, 2008.
- [20] Kenneth Price, Rainer Storn, and Jouni Lampinen. *Differential Evolution: A Practical Approach to Global Optimization*. Springer, 2005.
- [21] Bill Punch and Douglas Zongker. lil-gp 1.1. A genetic programming system. Available at <http://garage.cse.msu.edu/software/lil-gp/>, 1998.
- [22] Conor Ryan, J. J. Collins, and Michael O’Neill. Grammatical evolution: Evolving programs for an arbitrary language. In *EuroGP 1998*, pages 83–96, 1998.
- [23] Lee Spector. Simultaneous evolution of programs and their control structures. In Peter J. Angeline and K. E. Kinnear, Jr., editors, *Advances in Genetic Programming 2*, chapter 7, pages 137–154. MIT Press, 1996.
- [24] Lee Spector, Jon Klein, and Martin Keijzer. The Push3 execution stack and the evolution of control. In *Proceedings of the Genetic and Evolutionary Conference (GECCO 2005)*, pages 1689–1696. Springer, 2005.
- [25] Lee Spector and Alan Robinson. Genetic programming and autoconstructive evolution with the push programming language. *Genetic Programming and Evolvable Machines*, 3(1):7–40, 2002.
- [26] N. Srinivas and Kalyanmoy Deb. Multiobjective optimization using nondominated sorting in genetic algorithms. *Evolutionary Computation*, 2:221–248, 1994.
- [27] Kenneth O. Stanley and Risto Miikkulainen. Evolving neural networks through augmenting topologies. *Evolutionary Computation*, 10(2):99–127, 2002.
- [28] Keith Sullivan, Sean Luke, Curt Larock, Sean Cier, and Steven Armentrout. Opportunistic evolution: efficient evolutionary computation on large-scale computational grids. In *GECCO ’08: Proceedings of the 2008 GECCO conference companion on Genetic and evolutionary computation*, pages 2227–2232, New York, NY, USA, 2008. ACM.

- [29] Seth Tisue and Uri Wilensky. Netlogo: A simple environment for modeling complexity. In *International Conference on Complex Systems*, pages 16–21, 2004.
- [30] Jie Xu, Barry L. Nelson, and L. Jeff Hong. Industrial strength COMPASS: A comprehensive algorithm and software for optimization via simulation. *ACM Transactions on Modeling and Computer Simulation*, 20(1):1–43, 2010.
- [31] Jie Xu, Barry L. Nelson, and L. Jeff Hong. An adaptive hyperbox algorithm for high-dimensional discrete optimization via simulation problems. *INFORMS Journal on Computing*, 25(1):133–146, 2013.
- [32] Eckart Zitzler, Marco Laumanns, and Lothar Thiele. SPEA2: Improving the strength pareto evolutionary algorithm for multiobjective optimization. In K. Giannakoglou, D. Tshalis, J. Periaux, K. Papailiou, and T. Fogarty, editors, *Evolutionary Methods for Design, Optimization, and Control*, pages 19–26, 2002.

Index

- (+), 193
- (if ...), 191
- (if *test then else*), 191
- (matrix-multiply), 193
- (sin ...), 193
- (sin ...), 191
- 50, 204
- ../c/bar.params, 32
- ../z.params, 20
- .class, 17, 24, 32
- .dot, 180, 181
- .gz—hyperpage, 96
- /a/b/Foo.class, 32
- /a/c/bar.params, 32
- /tmp/, 38
- /tmp/population.in, 71
- /tmp/subpopulation.in, 72
- \$meta.stat, 296
- \$out.stat, 296
- 0.1, 95
- 0.25448855944201476, 204
- 0.4099041340133447, 204
- 2.34, 175
- 3.14, 175

- 111, 204

- a.params, 19
- accept(), 240
- addRandomRule(...), 228
- adf0.grammar, 208
- ADF1, 202
- ALL_MESSAGE_LOGS, 34
- allValid(...), 90, 91
- alternative-termination, 282
- altGeneratorTries, 282
- AntSpecies, 288, 289
- app/ant/ant.params, 24
- ARG0, 202
- argposition, 149, 161
- assessFitness[], 256
- Atan, 215
- auto, 49

- b.params, 19
- bar, 19
- base, 25
- base(), 60
- base.params, 295
- best, 240, 241
- betterThan, 275
- betterThan(), 155
- blah, 201
- boolean, 127, 134
- boolean[0], 301
- breed.f-noise, 270
- breed.pf, 270
- Breeder, 9, 10
- BreedingPipeline, 10
- BreedingPipeline.DYNAMIC_SOURCES, 86–88
- BreedingSource.fillStubs(...), 92
- breedthreads, 269
- buildOutput(), 49
- byte, 127
- byte, short, int, long, 129, 135
- ByteVectorIndividual, 62

- c.params, 19
- c1, 282
- cc, 283
- CHANGES, 14
- checkConstraints(), 157, 175
- checkConstraints(...), 174, 175, 186
- children[], 149
- childtypes, 150
- Class.getResource(...), 17
- classes, 15
- cleanup(...), 48, 49
- clone(), 66, 69, 75, 80, 154, 155, 194, 214, 227
- clone(...), 144
- Cloneable, 54
- CloneNotSupportedException, 59
- cmu, 282
- Code, 37
- Code.decode(decodeReturn), 37
- combine(...), 301
- CompetitiveEvaluator, 9

Component, 288
 constraints, 149
 ConstructionRule, 288, 289, 292
 ConstructiveBreeder, 289
 ConstructiveIndividual, 289
 ConstructiveProblemForm, 288
 cont, 257
 context, 249, 250, 257
 context[index], 257
 contextIsBetterThan(...), 259
 contract(...), 300
 copyTo(...), 154, 155, 194
 cos, 148
 countVictoriesOnly, 251, 254
 crossover(...), 128
 crossover-probability, 131
 crossover-type, 133, 216
 CrossoverPipeline, 10
 cs, 283
 curmudgeon, 38

 d.params, 19
 damps, 283
 decode(...), 184
 DecodeReturn.getFloat(), 36
 defaultBase(), 60, 66, 69, 75, 80, 144, 227
 defaultCrossover(...), 132
 describe(), 53
 describe(...), 53, 75–77, 96, 97, 111, 156, 251, 298, 301
 distanceTo(...), 67, 182
 do-depth, 160
 do-final, 273
 do-size, 99, 100, 159, 160
 do-subpops, 159
 do-time, 99, 100, 159, 160
 docs, 14, 15
 domain, 301
 double, 127
 Double.MAX_VALUE, 202, 204
 Double.MAX.Value, 203
 Double.POSITIVE_INFINITY, 67, 75
 double[0], 301
 double[], 141
 DoubleVectorIndividual, 139
 DoubleVectorIndividual, 293

 ec, 15, 17, 38
 ec.parsimony.BucketTournamentSelection, 197
 ec.parsimony.DoubleTournamentSelection, 198
 ec.parsimony.LexicographicTournamentSelection, 197
 ec.parsimony.ProportionalTournamentSelection, 198

 ec.parsimony.TarpeianStatistics, 199
 ec.4.gz, 39
 ec.generation.gz, 38
 ec.app.ant.Ant, 20
 ec.app.moosuite, 277, 278
 ec.app.myapp.MyMasterProblem, 239
 ec.app.myapp.MyProblem, 207
 ec.app.myapp.X, ec.app.myapp.Y,
 ec.app.myapp.Mul, ec.app.myapp.Sub,
 ec.app.myapp.Sin, 152
 ec.app.xor, 219
 ec.breed, 89
 ec.breed.BufferedBreedingPipeline, 89, 121
 ec.breed.CheckingPipeline, 90
 ec.breed.FirstCopyPipeline, 92, 125
 ec.breed.ForceBreedingPipeline, 90
 ec.breed.GenerationSwitchPipeline, 91
 ec.breed.InitializationPipeline, 89
 ec.breed.MultiBreedingPipeline, 89, 131
 ec.breed.RepeatPipeline, 90
 ec.breed.ReproductionPipeline, 89
 ec.breed.StubPipeline, 92, 125
 ec.breed.UniquePipeline, 91
 ec.breed.vector, 205
 ec.Breeder, 59, 77, 111
 ec.BreedingPipeline, 80, 86
 ec.BreedingSource, 80
 ec.Clique, 59
 ec.coevolve, 249
 ec.coevolve.CompetitiveEvaluator, 249, 253, 254, 262
 ec.coevolve.GroupedProblemForm, 52, 250, 256, 258
 ec.coevolve.MultiPopCoevolutionaryEvaluator, 249,
 254, 256
 ec.coevolve.MultiPopCoevolutionEvaluator, 262
 ec.de, 267
 ec.de.Best1BinDEBreeder, 269
 ec.de.DEBreeder, 267
 ec.de.DEEvaluator, 267
 ec.de.Rand1EitherOrDEBreeder, 270
 ec.DEBreeder.CR_UNSPECIFIED, 268
 ec.DefaultsForm, 111
 ec.eda, 278
 ec.eda.amalgam.AMALGAMSpecies, 283
 ec.eda.cmaes.CMAESBreeder, 280
 ec.eda.cmaes.CMAESInitializer, 280
 ec.eda.cmaes.CMAESSpecies, 280
 ec.eda.dovs.DOVSSpecies, 286
 ec.eda.dovs.HyperboxSpecies, 286
 ec.es, 109, 113
 ec.es.ESDefaults, 114
 ec.es.ESSelection, 113
 ec.es.MuCommaLambdaBreeder, 113

ec.es.MuPlusLambdaBreeder, 113
 ec.eval, 231
 ec.eval.Job, 258
 ec.eval.MasterProblem, 232
 ec.eval.MetaProblem, 293, 295
 ec.eval.Slave, 234
 ec.eval.SlaveConnection, 232
 ec.eval.SlaveMonitor, 232
 ec.Evaluator, 59, 73, 111, 234
 ec.EvolutionState, 18, 38, 42, 47, 48, 57, 59, 111
 ec.EvolutionState.R_FAILURE, 102
 ec.EvolutionState.R_SUCCESS, 102
 ec.Evolve, 17, 18, 24, 47–49, 57, 233
 ec.evolve, 302
 ec.evolve.RandomRestarts, 302
 ec.exchange, 241
 ec.exchange.InterPopulationExchange, 245
 ec.exchange.IslandExchange, 241
 ec.Exchanger, 59, 95, 111
 ec.Finalizer, 59
 ec.Finisher, 53, 111
 ec.Fitness, 111, 155, 249, 251
 ec.gp, 71, 146
 ec.gp.ADF, 185, 186
 ec.gp.ADFArgument, 186, 187
 ec.gp.ADFContext, 188
 ec.gp.ADFStack, 154, 156, 188
 ec.gp.breed, 164
 ec.gp.breed.InternalCrossoverPipeline, 166
 ec.gp.breed.MutateAllNodesPipeline, 168
 ec.gp.breed.MutateDemotePipeline, 167
 ec.gp.breed.MutateERCPipeline, 169
 ec.gp.breed.MutateOneNodePipeline, 168
 ec.gp.breed.MutatePromotePipeline, 167
 ec.gp.breed.MutateSwapPipeline, 168
 ec.gp.breed.RehangPipeline, 168
 ec.gp.breed.SizeFairCrossoverPipeline, 170
 ec.gp.build, 161
 ec.gp.build.PTC1, 162
 ec.gp.build.PTC2, 163
 ec.gp.build.PTCFunctionSet, 163
 ec.gp.build.PTCFunctionSetForm, 162
 ec.gp.build.RandomBranch, 164
 ec.gp.build.RandTree, 164
 ec.gp.build.Uniform, 164
 ec.gp.ERC, 183, 203
 ec.gp.ge, 199
 ec.gp.ge.breed.GETruncationPipeline, 205
 ec.gp.ge.GEIndividual, 199
 ec.gp.ge.GEProblem, 200
 ec.gp.ge.GESpecies, 200
 ec.gp.ge.GESpecies.BIG_TREE_ERROR, 203, 204
 ec.gp.ge.GrammarFunctionNode, 208
 ec.gp.ge.GrammarNode, 208
 ec.gp.ge.GrammarParser, 200, 208
 ec.gp.ge.GrammarRuleNode, 208
 ec.gp.GPAtomicType, 148, 196
 ec.gp.GPData, 154
 ec.gp.GPFunctionSet, 148
 ec.gp.GPIndividual, 148
 ec.gp.GPInitializer, 160
 ec.gp.GPNode, 148
 ec.gp.GPNodeBuilder, 161
 ec.gp.GPNodeBuilder.NOSIZEGIVEN, 161
 ec.gp.GPNodeConstraints, 148
 ec.gp.GPNodeGatherer, 176
 ec.gp.GPNodeParent, 149
 ec.gp.GPNodeSelector, 164
 ec.gp.GPSetType, 148, 196
 ec.gp.GPSpecies, 148
 ec.gp.GPTree, 148, 149, 192
 ec.gp.GPTreeConstraints, 148
 ec.gp.GPType, 148, 191, 196
 ec.gp.koza, 161
 ec.gp.koza.Crossover, 164
 ec.gp.koza.CrossoverPipeline, 165
 ec.gp.koza.FullBuilder, 161
 ec.gp.koza.GrowBuilder, 161
 ec.gp.koza.HalfBuilder, 162
 ec.gp.koza.KozaNodeSelector, 164
 ec.gp.koza.KozaShortStatistics, 101, 256
 ec.gp.koza.Mutation, 164
 ec.gp.koza.MutationPipeline, 166, 212
 ec.gp.push, 209
 ec.gp.push.Nonterminal, 210–212
 ec.gp.push.PushBuilder, 211, 212
 ec.gp.push.PushInstruction, 214
 ec.gp.push.PushProblem, 213
 ec.gp.push.Terminal, 210–212
 ec.Individual, 59, 60, 64, 65
 ec.Initializer, 52, 59, 111
 ec.multiobjective, 271, 274
 ec.multiobjective.HypervolumeStatistics, 274
 ec.multiobjective.MultiObjectiveFitness, 271
 ec.multiobjective.MultiObjectiveStatistics, 273, 274
 ec.multiobjective.MultiobjectiveStatistics, 274
 ec.multiobjective.nsga2, 271, 276
 ec.multiobjective.nsga2.NSGA2Breeder, 79
 ec.multiobjective.nsga3, 276, 277
 ec.multiobjective.spea2, 271, 277
 ec.multiobjective.spea2.SPEA2Breeder, 79
 ec.multiobjective.spea2.SPEA2MultiObjectiveFitness, 278
 ec.multiobjective.spea2.SPEA2Subpopulation, 277

ec.mutiobjective.nsga2.NSGA2Breeder, 276
 ec.mutiobjective.nsga2.NSGA2MultiObjectiveFitness, 276
 ec.mutiobjective.nsga2.NSGA2Statistics, 276
 ec.neat, 215
 ec.neat.NEATBreeder, 216
 ec.neat.NEATGene, 215
 ec.neat.NEATIndividual, 215
 ec.neat.NEATInitializer, 216
 ec.neat.NEATInnovation, 215
 ec.neat.NEATNetwork, 215
 ec.neat.NEATNode, 215
 ec.neat.NEATSpecies, 215
 ec.neat.NEATSubspecies, 215
 ec.Parameter, 25
 ec.parsimony, 67, 197
 ec.Population, 22, 58, 61
 ec.Problem, 75
 ec.Prototype, 59, 214
 ec.pso, 263
 ec.pso.Particle, 263
 ec.pso.PSOBreeder, 264
 ec.rule, 71, 222
 ec.rule.breed.RuleCrossoverPipeline, 222, 229
 ec.rule.breed.RuleMutationPipeline, 222, 228
 ec.rule.Rule, 222, 223, 226
 ec.rule.RuleConstraints, 222
 ec.rule.RuleIndividual, 222
 ec.rule.RuleMutationPipeline, 225
 ec.rule.RuleSet, 222
 ec.rule.Ruleset, 223
 ec.rule.RuleSetConstraints, 222
 ec.rule.RuleSpecies, 222
 ec.ruleRuleSet, 222
 ec.select, 83
 ec.select.AnnealedSelection, 83, 125
 ec.select.BestSelection, 84, 85, 114
 ec.select.BoltzmanSelection, 84
 ec.select.FirstSelection, 83
 ec.select.FitProportionateSelection, 82, 84, 155
 ec.select.GreedyOverselection, 85
 ec.select.MultiSelection, 86
 ec.select.RandomSelection, 83
 ec.select.SigmaScalingSelection, 84
 ec.select.SUSSelection, 84
 ec.select.TopSelection, 83, 123, 124
 ec.select.TournamentSelection, 85
 ec.SelectionMethod, 80
 ec.Setup, 59
 ec.simple, 60, 109, 111, 113
 ec.simple.Finisher, 70
 ec.simple.SimpleBreeder, 77, 111, 256
 ec.simple.SimpleDefaults, 60, 111
 ec.simple.SimpleEvaluator, 73, 111
 ec.simple.SimpleEvolutionState, 47, 102, 111, 237
 ec.simple.SimpleExchanger, 95, 111
 ec.simple.SimpleFinisher, 111
 ec.simple.SimpleFitness, 60, 62, 68, 111
 ec.simple.SimpleInitializer, 71, 111
 ec.simple.SimpleProblemForm, 74–76, 111
 ec.simple.SimpleShortStatistics, 96, 98, 101, 111
 ec.simple.SimpleStatistics, 95, 96, 101, 111, 256, 258
 ec.simple.SteadyStateEvaluator, 74
 ec.simple.SteadyStateEvolutionState, 237
 ec.singlestate, 122
 ec.Singleton, 59
 ec.spatial, 254, 259
 ec.spatial.Space, 259
 ec.spatial.Spatial1DSubpopulation, 261
 ec.spatial.SpatialBreeder, 79, 261
 ec.spatial.SpatialMultiPopCoevolutionaryEvaluator, 262
 ec.spatial.SpatialTournamentSelection, 261
 ec.Species, 60, 64, 71, 81
 ec.Statistics, 59, 95, 111
 ec.steady.SteadyStateDefaults, 119
 ec.steadystate, 102, 117
 ec.steadystate.QueueIndividual, 238
 ec.steadystate.SteadyStateBreeder, 79, 118
 ec.steadystate.SteadyStateBSourceForm, 118
 ec.steadystate.SteadyStateEvaluator, 118
 ec.steadystate.SteadyStateEvolutionState, 117
 ec.steadystate.SteadyStateExchangerForm, 119
 ec.steadystate.SteadyStateStatisticsForm, 95, 120
 ec.subpop, 23
 ec.subpop.species, 24
 ec.Subpopulation, 23, 61
 ec.util.Code, 35, 65, 68, 70
 ec.util.DataPipe, 54, 259
 ec.util.DecodeReturn, 36
 ec.util.IntBag, 81
 ec.util.MersenneTwisterFast, 42, 43
 ec.util.Output, 33, 34
 ec.util.ParamClassLoadException, 25, 26
 ec.util.ParameterDatabase, 18, 25
 ec.util.RandomChoice, 44
 ec.util.RandomChoiceChooser, 45
 ec.util.RandomChoiceChooserD, 45
 ec.util.ThreadPool, 46
 ec.util.ThreadPool.Worker, 46
 ec.vector, 94, 127, 141, 222, 223, 228
 ec.vector.BitVectorIndividual, 127
 ec.vector.breed, 128, 142
 ec.vector.breed.GeneDuplicationPipeline, 143, 205

- ec.vector.breed.ListCrossoverPipeline, 142
- ec.vector.breed.MultipleVectorCrossoverPipeline, 129, 131, 133
- ec.vector.breed.VectorCrossoverPipeline, 128, 130
- ec.vector.breed.VectorMutationPipeline, 125, 128, 133
- ec.vector.ByteVectorIndividual, 127
- ec.vector.DoubleVectorIndividual, 127, 263, 280, 283
- ec.vector.FloatVectorSpecies, 127
- ec.vector.FloatVectorspecies, 263
- ec.vector.Gene, 127, 129, 144, 215
- ec.vector.GeneVectorIndividual, 127, 134, 144, 215
- ec.vector.GeneVectorSpecies, 127, 144
- ec.vector.IntegerVectorIndividual, 75
- ec.vector.IntegerVectorIndividual, 112, 127, 278
- ec.vector.IntegerVectorSpecies, 127
- ec.vector.LongVectorIndividual, 127
- ec.vector.ShortVectorIndividual, 127
- ec.vector.VectorCrossoverPipeline, 94
- ec.vector.VectorIndividual, 127
- ec.vector.VectorMutationPipeline, 93
- ec.vector.VectorSpecies, 127, 139
- ec/..., 17
- ec/app, 15
- ec/app/ant/Ant.class, 20
- ec/app/ant/Ant.java, 76
- ec/app/ant/ant.params, 20
- ec/app/ecsuite/amalgam.params, 285
- ec/app/ecsuite/cmaes.params, 283
- ec/app/ecsuite/hc.params, 123
- ec/app/ecsuite/hcsteep.params, 124
- ec/app/ecsuite/hcsteepwr.params, 125
- ec/app/ecsuite/sa.params, 126
- ec/app/highdimension, 286, 287
- ec/app/knapsack, 288, 289
- ec/app/lawnmower, 30
- ec/app/push, 215
- ec/app/regression/asyncmaster.params, 237
- ec/app/regression/asynclslave.params, 237
- ec/app/singular, 287
- ec/app/sum/pbil.params, 280
- ec/app/tsp, 288, 289
- ec/app/xor.params, 222
- ec/co, 288
- ec/co/aco, 288
- ec/display, 15
- ec/eda/dovs/dovs.params, 286
- ec/Evolve.class, 24
- ec/gp/koza/koza.params, 171, 174, 206
- ec/gp/push/push.params, 211
- ec/neat/neat.params, 222
- ecj, 14, 17
- ecj.jar, 17
- ecj/src/main/java/ec/, 15
- ecj/target/, 15
- ecsuite, 283, 285
- ecsuite.params, 103
- encode(), 183, 184
- equals(...), 67
- equalTo, 275
- equivalentTo, 275
- equivalentTo(), 155
- ERC, 202
- ERC1[3.14159], 183
- ERC2[921], 183
- ERC[3.14159], 183
- es.params, 115
- eval(...), 153, 154, 157
- eval.i-am-slave = true, 234
- eval.master.host, 299
- eval.masterproblem, 234
- eval.masterproblem.job-size, 234
- eval.problem.n..., 298
- eval.problem.runs = 10, 300
- eval.problem.silent, 299
- evalthreads, 78, 254, 256
- evaluate(), 50
- evaluate(...), 52, 74, 75, 77, 111, 156, 219, 237, 239, 250, 251, 254, 257
- evaluated, 75, 109, 199, 203, 287, 295
- evaluatedState, 55
- evaluations, 117, 299
- Evaluator, 9, 11, 96
- EvolutionState, 9, 46
- EvolutionState.evaluation, 111
- EvolutionState.generation, 111
- EvolutionState.R_FAILURE, 238
- EvolutionState.R_NOTDONE, 106
- EvolutionState.R_SUCCESS, 238
- EvolutionState.UNDEFINED, 57
- Evolve, 9
- exch.select.size, 246
- Exchanger, 9
- Execute(...), 214
- executeProgram(...), 214
- exitIfErrors(), 35
- expand(...), 300
- expectedChildren(), 157, 175, 184, 187
- f0, 151
- false, 79, 81, 89, 91, 141, 273, 296, 297
- file, 295
- finalStatistics, 273
- finalStatistics(...), 102
- Finisher, 9

finishEvaluating(...), 75, 237, 239
 finishProducing(...), 82, 87
 Fitness, 9, 11, 70
 fitness(), 69, 155, 275
 Fitness.clone(), 252
 Fitness.cloneTrials(), 252
 Fitness.contextIsBetterThan(Fitness other), 258
 Fitness.merge(...), 258
 Fitness.setContext(...), 251
 fitness.setToMeanOf(...), 301
 fitnessToString(), 69
 fixed, 302
 float, 127, 209, 297
 float, double, 129, 136
 float.* float.+ float.% float.- float.dup float.swap
 float.pop, 212
 float.+, 209
 float.erc, 212
 FloatVectorIndividual, 139
 FloatVectorSpecies, 139
 Foo, 32
 foo, 19, 28
 foo.mom.42, 29
 foo.threadnumber.out—hyperpage, 50
 front.stat, 273
 functionset, 150

 ga.params, 113
 gauss, 136, 296
 ge.params, 205, 207
 Gene, 139, 142
 generate-max, 89, 91
 Generational, 102
 generations, 299
 GeneVectorIndividual, 127, 139, 140, 142
 GeneVectorSpecies, 139
 genome, 132
 genome-size, 216
 genotypeToStringForHumans(), 67
 getFile(...), 21, 25
 getIndexRandomNeighbor, 260, 261
 getIndexRandomNeighbor(...), 261
 getInterpreter(...), 213
 getIslandIndex(...), 247
 getProgram(...), 213
 getResource(...), 21, 25
 gp.fs, 151
 gp.fs.2.info = ec.gp.GPFuncInfo, 31
 gp.tc, 151
 gp.type, 151
 GPNodeParent, 161
 GPTree.NO_TREENUM, 178

 GPType, 174
 Group, 61
 growp, 162

 hashCode(), 67
 hello.there, 28
 hey, 29
 hits, 155
 HypervolumeStatistics, 274

 id, 247
 if-food-ahead, 148
 ind-competes, 261
 index.html, 15
 Individual, 9–11
 Individual.merge, 259
 Individual.merge(...), 258
 Individuals, 9
 individuals, 77
 inds, 80, 88
 inds[start] ... inds[start+n-1], 83
 init, 150
 initialize(...), 49
 initialize(parameters, randomSeedOffset, output), 49
 Initializer, 9
 initialPopulation(...), 71
 input, 156
 int, 127
 int.erc, 212
 int[0], 301
 integer-reset, 298
 IntegerVectorIndividual, 62
 IntegerVectorSpecies, 62
 intermediate, 131
 InterPopulationExchange, 248
 Interpreter, 213
 interrupt(), 47
 isIdealFitness(), 69, 155
 island, 247
 IslandExchange.ISLAND_INDEX_LOOKUP_FAILED,
 247
 iterator(GPNode.NODESEARCH_ALL), 176

 jar, 32
 java.io.Serializable, 40, 59, 251
 java.lang.Cloneable, 59, 60
 java.lang.Double, 70, 249, 258, 259
 java.lang.Random, 14
 java.lang.Runnable, 46
 java.util.logging, 14
 java.util.Properties, 14, 54
 java.util.Random, 41–43, 51
 job-size, 233, 237

- job.3.out.stat, 47
- job.jobnumber., 47
- jobs.5.out.stat.gz—hyperpage, 96
- jobs.5.out.stat—hyperpage, 96
- jobs.*n*.—hyperpage, 96

- koza.params, 171
- KozaFitness, 70

- lambda, 282
- LICENSE, 14
- likelihood, 88, 131
- line, 131
- loadDomain(...), 300, 301
- local-repo, 14
- long, 127
- LongVectorIndividual, 62

- main, 103
- main(...), 50
- Makefile, 14
- map(...), 301
- mate-only-prob, 217
- mate-only-probability, 217
- Math.random(...), 51
- max, 80
- max-jobs-per-slave, 233, 237
- maxGene(), 128
- maxGene(...), 301
- MAXIMUM_PASSES, 203
- maxsize, 165, 166
- mean, 240, 241
- median, 240, 241
- merge(...), 258
- MersenneTwister, 11
- MersenneTwisterFast, 11
- min, 80
- minChildProduction(), 87
- minGene(), 128
- minGene(...), 301
- misc, 80–82
- modifyParameters(...), 301
- modulus, 159
- moosuite.params, 277, 278
- mu, 282
- Mul, 173
- MultiBreedingPipeline, 10
- MultiobjectiveFitness, 70
- MultiObjectiveStatistics, 274
- MultiPopCoevolutionaryEvaluator, 9
- must-clone, 89
- mutate(...), 128, 225, 228, 229
- mutate-only-prob, 217

- mutateERC(), 169
- mutateERC(...), 184
- mutation-prob, 115, 216
- my.machine.ip.address, 299
- MyData, 174
- MyProblem, 174
- myproblem.grammar, 208
- MyTestProblem, 294

- name, 150, 186, 187
- name(), 183, 186, 187, 202
- nc0, 152, 185
- nc1, 152
- nc2, 152
- neighborhood-size, 261
- new, 9, 14
- newFitness.setContext(oldFitness.getContext(context)), 257
- newIndividual(...), 71, 280, 283
- newIndividual(EvolutionState, int), 228
- newpop.subpops.get(subpopulation).species, 81
- nextInt(), 43, 50
- nil, 151, 152
- NO_LOGS, 34
- nodeEquals(...), 175
- nodeEquivalentTo(...), 175
- nodeHashCode(), 183
- nodes, 215
- ns, 166, 167
- ns.0, 166, 167
- ns.1, 166, 167
- null, 25, 29, 49, 74, 81, 92, 93, 247, 249, 257, 269
- num-buckets, 198
- num-children, 274
- num-inds, 90, 91
- num-tests, 300
- numEvaluations, 57
- numGenerations, 57
- numRules \leq rules.length, 223
- numRulesForReset(...), 228
- numSources(), 88

- one-point, 131
- one-point-nonempty, 131
- org.spiderland.Psh.Instruction, 214
- other, 259
- other.fitness.merge(fitness), 259
- other.writeIndividual(...), 259
- out-of-bounds-retries, 136, 137
- out.stat, 47, 96
- Output, 11, 54

- p, 106

p_add, 228, 229
 p_del, 228, 229
 p_randorder, 229
 ParameterDatabase, 9, 11
 parent, 149
 parent.0 = ../../gp/koza/koza.params, 31
 passes, 203
 PheromoneTable, 288
 pick-worst, 85, 261
 pickNode(...), 164, 165
 pieces, 142
 points, 224
 points.length = 0, 224
 points[0], 224
 points[i+1], 224
 points[i], 224
 points[points.length - 1], 224
 polynomial, 136, 296
 pom.xml, 14
 pop, 22
 pop.default-subpop, 78, 246, 256
 pop.subpop.0, 25
 pop.subpop.0.size, 25, 299
 pop.subpop.0.species, 23, 24, 206
 pop.subpop.0.species...n, 298
 pop.subpop.0.species.alternative-polynomial-
 version, 296
 pop.subpop.0.species.gp-species, 206
 pop.subpop.0.species.mutation-distribution-index,
 296
 pop.subpop.0.species.mutation-prob, 296
 pop.subpop.0.species.mutation-stdev, 296
 pop.subpop.0.species.mutation-type, 296
 pop.subpop.0.species.out-of-bounds-retries = 100,
 298
 pop.subpop.0.species.pipe.source.1.source.1.scaled-
 fitness-floor, 95
 pop.subpop.1, 62
 pop.subpop.1.species, 23, 24
 pop.subpop.2, 62
 pop.subpops, 22
 populate(...), 71
 Population, 9
 possiblyRestoreFromCheckpoint(...), 49
 postCheckpointStatistics(...), 41
 postprocessIndividual(...), 229, 230
 postprocessPopulation, 254, 256
 postprocessPopulation(...), 251, 255
 postProcessRules(...), 229
 postprocessRules(...), 229, 230
 preBreedingExchangePopulation(...), 95
 preCheckpointStatistics(...), 40
 preparePipeline(...), 87
 prepareToEvaluate(...), 75, 237, 239
 prepareToProduce(...), 80, 82–84, 87, 90, 92
 preprocessIndividual(...), 228, 229
 preprocessPopulation(...), 251
 preprocessRules(...), 228, 229
 Print, 215
 print-unaccessed-params, 30
 printFitness(...), 69
 printFitnessForHumans(...), 69, 257
 printIndividual() or writeIndividual(), 264
 printIndividual(..., 68
 printIndividual(...), 67, 68
 printIndividualForHumans, 65
 printIndividualForHumans(), 264
 printIndividualForHumans(...), 67, 96, 204
 printPopulation(...), 65, 72
 printPopulationForHumans(...), 65
 printRule(...), 228
 printRuleSet(...), 226
 printRuleSetToString(...), 226
 printRuleToString(), 227
 printRuleToString(...), 228
 printRuleToStringForHumans(), 227
 printSubpopulationForHumans(...), 65
 printTree(...), 179
 probabilityOfSelection, 150
 Problem, 11, 50, 53
 problem, 75
 process, 247
 process(...), 247, 248
 produce(), 89
 produce(...), 81, 82, 88, 90, 92
 produces, 81
 produces(...), 87
 produceWithoutCloning(), 82
 produceWithoutCloning(...), 82
 producewithoutCloning(...), 82
 Program, 213
 push.params, 212
 random, 42, 265, 281, 302
 random-each-time, 265
 random-walk, 135
 random-walk-probability, 135
 randomizeRulesOrder(...), 229
 readFitness(..., DataInput), 70
 readFitness(..., LineNumberReader), 70
 readIndividual(...), 64, 68, 259
 readIndividual(..., DataInput), 68
 readIndividual(..., LineNumberReader), 68
 README.md, 14

readNode(...), 177, 184
 readPopulation(..., DataInput), 66
 readPopulation(..., LineNumberReader), 66, 71
 readSubpopulation(..., LineNumberReader), 72
 readTree(..., DataInput), 179
 readTree(..., LineNumberReader), 179
 receiveAdditionalData(...), 239, 240
 reevaluate, 295
 reinitializeContacts(...), 41
 removeRandomRule(...), 228
 requestedSize, 161
 reset, 135, 136, 296
 reset(), 164, 204
 reset(...), 144, 224, 225, 227–229
 resetFromCheckpoint(...), 41
 resetInterpreter(...), 213
 resetNode(...), 184
 restart(...), 41
 restoreFromCheckpoint(...), 41
 result, 102, 238
 rules, 223
 rules[0] ... rules[numRules – 1], 223
 run(...), 41, 48
 runs, 295

 same, 87, 165
 sbx, 132
 seed, 24
 select.boltzman, 85
 select.greedy, 85
 select.multiselect, 86
 select.sigma-scaling, 84
 select.tournament, 85, 261
 select.tournament.size, 246
 SelectionMethod, 10
 SelectionMethod.INDS_PRODUCED, 81
 SelectionMethod.java, 81
 sendAdditionalData(...), 239
 set, 161
 set-random, 295
 setCheckpoint(...), 40
 sets, 224
 sets[0], 224
 sets[1], 224
 sets[i], 224
 sets[points.length], 224
 setToMeanOf(...), 70, 293
 setup(), 51
 setup(...), 14, 22, 23, 47, 52, 59, 66, 69, 75, 80, 87, 88, 92, 95, 144, 156, 214, 227, 280, 300, 301
 setupPopulation(...), 71
 short, 127

 ShortVectorIndividual, 62
 sigma, 281
 silent, 101
 sim.util.distribution, 44
 simple, 216
 simple.fitness, 60
 SimpleEvaluator, 9
 SimpleEvolutionState, 8, 110, 288, 289
 SimpleEvolutionState.numEvaluations, 109
 SimpleEvolutionState.numGenerations, 109
 SimpleFitness, 70
 SimpleStatistics, 55
 Sin, 173
 sin, 202
 size, 23, 25, 246, 261, 262
 size(), 67, 197
 sources.length, 87
 sparsity, 277
 Species, 9, 10, 288
 splitIntoTwo(...), 229
 src, 15
 src/main/java/ec/, 15
 src/main/java/resources/ec, 15
 src/main/java/resources/ec/, 15
 start.in, 287
 start.neatind, 221
 startFresh(), 47, 52
 startFresh(...), 47
 startFromCheckpoint(), 52
 startFromCheckpoint(...), 41
 stat.file, 296
 stat.silent, 298, 299
 state, 48, 62, 149
 state.evalthreads, 50
 state.evolve(), 103, 106
 state.finish(...), 103
 state.parameters, 59
 state.population, 74, 106
 state.population.subpops.get(subpop), 268
 state.population.subpops.get(subpop).individuals.get(index), 268
 state.population.subpops.get(subpopulation).f_prototype, 81
 state.R_NOTDONE, 103
 state.random[thread], 51
 state.run(...), 103
 state.startFresh(), 103
 StatenIsland, 242
 Statistics, 9
 stderr, 54
 stdout, 54
 SteadyStateEvaluator, 9

SteadyStateEvolutionState, 116, 236, 288, 290
 String[...], 301
 stub, 87, 92
 Sub, 173
 subpop, 247
 subpops, 22
 Subpopulation, 9, 10
 subpopulation, 80
 super(), 186
 super(...), 102, 174
 super.newIndividual(...), 228
 super.setup(...), 59

T.ERROR, 37
 target, 14
 tc0, 151
 tcsh, 48
 test(...), 176
 thread, 51
 ThreadLocal, 46
 time, 242
 toroidal, 265
 toss, 165
 toss=true, 165
 toString, 175
 toString(), 32, 67, 68, 70, 145, 157, 177, 184, 227
 toString()., 175
 toStringForHumans(), 177, 184
 transferAdditionalData(...), 239, 240
 trees[], 178
 treetype, 150
 trials, 249, 251, 252, 258
 true, 34, 79, 81, 91, 271, 295–297
 two-point, 131, 142
 two-point-nonempty, 131
 type, 161, 261
 typicalIndsProduced(), 81, 87

UNDEFINED, 57
 uniform, 131, 261
 updateDistribution(...), 280, 283
 updateFitness, 251, 254
 updateIndividual(...), 288
 UpdateRule, 288, 289
 updateSubpopulation(...), 288

val, 194

whoa, 29
 wrap, 222
 writeFitness(...), 70
 writeIndividual(...), 68
 writeNode(...), 184
 writePopulation(...), 66
 writeState(...), 44
 writeTree(...), 179

X, 173
 XOR, 219
 XOR.java, 219

Y, 173

z.params, 20
 zeroChildren[], 150